



# LABORATORY GLASSWARE

## PRICE LIST 2026-27





National Accreditation Board for  
Testing and Calibration Laboratories

NABL

**CERTIFICATE OF ACCREDITATION**

**CALIBRATON LAB JAIN SCIENTIFIC GLASS WORKS**

has been assessed and accredited in accordance with the standard

**ISO/IEC 17025:2017**

**"General Requirements for the Competence of Testing &  
Calibration Laboratories"**

for its facilities at

14 INDUSTRIAL AREA, AMBALA CANTT, AMBALA, HARYANA, INDIA

in the field of

**CALIBRATION**

Certificate Number: CC-3285

Issue Date: 21/09/2025

Valid Until: 20/09/2029

This certificate remains valid for the Scope of Accreditation as specified in the annexure subject to continued satisfactory compliance to the above standard & the relevant requirements of NABL.  
(To see the scope of accreditation of this laboratory, you may also visit NABL website [www.nabl-india.org](http://www.nabl-india.org))

Name of Legal Entity: JAIN SCIENTIFIC GLASS WORKS

Signed for and on behalf of NABL



  
Anita Rani  
Director

  
N. Venkateswaran  
Chief Executive Officer

**MECHANICAL  
CALIBRATION**





An ISO 9001:2015 Certified

## LABORATORY GLASSWARE & EQUIPMENT

### ADDRESS

14, HSIIDC, Industrial Estate,  
Jagadhari Road,  
Ambala Cantt. - 133 001  
Haryana - INDIA



### E-mail

info@jsgw.com  
sales@jsgw.com  
Web : www.jsgw.com



### GST No.

06AACFJ4661N1Z3



### PHONES

91-171-2698184  
91-171-2698185



# JAIN SCIENTIFIC GLASS WORKS

Complete Source of Laboratory Glassware & Equipment

14, HSIIDC, Industrial Estate, Jagadhari Road, Ambala Cantt. - 133 001 Haryana - INDIA

# Foreword

Very humbly, we present herewith our latest **2026** Catalogue-cum-Price List. "JSGW" mouth blown Laboratory Glassware's are fabricated from low alkali borosilicate type 3.3 glass, having Chemical Composition Si O<sub>2</sub> :81%, B<sub>2</sub> O<sub>3</sub> :13%, Na<sub>2</sub> O / K<sub>2</sub>O: 4% Al<sub>2</sub> O<sub>3</sub> :2% approx. by weight.

The Thermal Properties of Glass are Coefficient of Linear Expansion  $32.5 \times 10^{-7} / ^\circ\text{C}$ , Strain Point :515°C, Annealing Point :565°C, Softening Point :820°C, Specific Heat: 0.2 and Thermal Conductivity (Cal/cm<sup>3</sup> /°C/Sec):0.0027:

It has been mentioned, in our catalogue where any other type of glass is used, Viz. Quartz, Silica, Borosilicate Neutral or Soda Glass etc.

This Catalogue-cum-Price list covers a wide range of apparatuses required for Colleges, Universities, Pharmaceuticals Industries, Research & Development Organizations.

To give you a clear indication of what is being offered we have tried to maximize the use of illustrations and figures.

We are in this line of mouth blown glassware for more than six decades.

Our workshop is very well equipped with modern and latest plant, machinery, equipment and experienced staff.

Quality is controlled by our experts at every step of manufacturing to maintain accuracy and perfectness. We can really offer you high class mouth blown products, equivalent to those manufactured anywhere in the developed countries.

We are having **NABL** accreditation in two disciplines, viz Chemicals Testing (To determine the Chemical Composition of glass) and Mechanical Calibration (Volume for glassware & Thermal for Thermometers).

We are registered with N.S.I.C. New Delhi, and MSME as a Small Scale Unit.

We have **ISI mark** for Volumetric Flasks, Measuring Cylinders, Pipettes, Burettes, Beakers and Flasks etc.

We also undertake to custom manufacturing of new apparatus according to customers specifications. All enquiries for research are dealt with promptly.

While placing your valued order, please mention our catalogue numbers, minimum Qty/Pack along with a short description.

In the end, we sincerely thank all patrons and clients, old and new, for their indulgent co-operation in the past.

We fully assure you that all your enquiries and valued orders will receive our best and prompt attention, as usual.

Management  
**Jain Scientific Glass Works**

# A

# INDEX

ADAPTERS			BOTTLES		
	Cat.No.	Page No.		Cat.No.	Page No.
Adapters, Reduction	213	62	Bottles Reagent, Screw Cap GL45	566A	110
Adapters, Expansion	214	62	Bottles Reagent, Screw Cap, Amber	566B	111
Adapters, Multiple	216-218	63	Bottles Reagent, Extra WM, Screw Cap, GL 80	567	111
Adapters, Swan Neck	219	63	Bottles Reagent, Extra WM, Screw Cap, Amber GL 80	567A	111
Adapters, Receiver	220	63	Reagent Bottle, High Recovery	568	112
Adapters, Receiver, Bend with Vent	222	64	Reagent Bottle, Multi-Neck	569	112
Adapters, Receiver, Bend, Vacuum	223	64	Bottles, Dropping	570	112
Adapters, Receiver, Multiple, Pig	225	64	Bottles, Dropping, Amber	570A	112
Still Head, Recovery Bend (Elbow)	231	65	Bottles, Aspirator, with STPK	571	112
Still Head, Recovery Bend (Vertical)	232	65	Bottles, Aspirator, with Tubulation	571A	112
Recovery Head	233	65	Bottles, Woulf	573	113
Claisen Head	234	65	Bottles, Mac-Cartney	574	113
			Bottles, BOD	575	113
			Bottle, Roux	576	113
			Bottles, Gas Washing	692	120
			Bottles, Gas Washing, with Sintered Disc	694	120
			Bottles, Wash, I/C	845	123
ARSENIC APPRATUS			BURETTES		
	Cat.No.	Page No.		Cat.No.	Page No.
Arsenic App. - Gutzeit	905	131	Burette Pich Cork	1	1
Arsenic App. - BP	902	131	Burette, Glass Stpk, Class A	2	1
Arsenic App. - Silver Diethyldithio	903	131	Burette, Glass Stpk, NABL	2N	1
Arsenic App. For Ferrous Alloys	904	131	Burette, Glass Stpk, Amber Class A	2A	1
Arsenic App.- USP 211	906	131	Burette, Glass Stpk, Class B	3	2
Arsenic App.- IP	907	131	Burette, PTFE Needle Valve, Class A	4	2
Arsenic App.- JP	908	131	Burette, PTFE Needle Valve, NABL	4N	2
Arsenic App.- EP	909	131	Burette, PTFE Needle Valve, Class B	5	3
			Burette, PTFE Stpk, Class A	6	3
			Burette, PTFE Stpk, NABL	6N	3
			Burette, PTFE Stpk, Amber Class A	6A	3
			Burette, PTFE Stpk, Class B	7	4
			Burette, Double Oblique Bore	10, 11	4
			Burette, Three Way Bore Needle Valve	12,13	4-5
			Burette, Double Oblique Bore	14	5
			Burette, Over Flow Cup, Glass Stpk	15,16	5
			Burette, Over Flow Cup, Needle Valve	17,18	5
			Burette, Over Flow Cup, PTFE Stpk	19	6
			Burette, Micro, Auto Filling	20,21	6
			Burette, Auto., Glass Stpk, Class A	22	6
			Burette, Auto., Glass Stpk, NABL	22N	6
			Burette, Auto., Glass Stpk, Amber Class A	22A	7
			Burette, Auto., Glass Stpk, Amber, NABL	22AN	7
			Burette, Auto., Glass Stpk, Class B	23	7
			Burette, Auto., Needle Valve, Class A	24	7
			Burette, Auto., Needle Valve, NABL	24N	7
			Burette, Auto., Needle Valve, Amber, Class A	24A	8
BEAKERS			BOTTLES		
	Cat.No.	Page No.		Cat.No.	Page No.
Beakers, With Plastic Handle	547	106	Bottles, Weighing	551	107
Beakers, Low Form with Spout	548	106	Bottles, Weighing, Amber	552	107
Beakers, Amber, Low Form	548A	106	Bottles, Weighing, Cap Type	553-554	107
Beakers, Tall Form with Spout	549	106	Bottles, Weighing, Suba Seal	555	108
Beakers, Tall Form without Spout	549A	106	Bottle, Lunges	556	108
Beakers, Philips, with Spout	550	107	Bottles, Specific Gravity, Class A	557	108
Beaker, Tong	550A	107	Bottles, Specific Gravity, NABL	557N	108
Beaker, Brush	550B	107	Bottles, Specific Gravity	558	108
			Bottles, Specific Gravity, Pkymometer	559A	108
			Bottles, Specific Gravity, Weld	560	109
			Bottles, Specific Gravity, Hubbard	561	109
			Bottles, Reagent, Glass Stopper	563	109
			Bottles, Reagent, Glass Stopper, Amber	563A	109
			Bottles, Reagent, WM, Glass Stopper	564	110
			Bottles Reagent, NM, Screw Cap	565	110
			Bottles Reagent, WM, Screw Cap	566	110

# B

# INDEX

BURETTES			CLAMPS & STANDS		
	Cat.No.	Page No.		Cat.No.	Page No.
Burette, Auto., Needle Valve, Class B	25	8	Boss Head	1260-1262	160
Burette, Automatic, PTFE Stpk, Class A	26	8	Stand Rectangular	1264	160
Burette, Automatic, PTFE Stpk, NABL	26N	8	Stand Tripod	1265-1267	160-161
Burette, Auto., PTFE Stpk, Amber, Class A	26A	8	Stand - A Shape	1266	161
Burette, Auto., PTFE Stpk, Amber, NABL	26AN	9	Retort Ring	1268	161
Burette, Karl Fisher, Class A	27	9	Crucible Tongs	1269-1271	161
Burette, Spare Bellow	30	9			
Burette, Cleaning Brush	31	9			
Burette, Stand & Clamp	32	9			
BURNERS			CLINICAL LABORATORY GLASSWARE		
	Cat.No.	Page No.		Cat.No.	Page No.
Bunsen Burner	1272	161	Albuinometer	580	113
Bunsen Burner - Needle Valve	1272/2	161	Ureometer Doremus	581	113
Bunsen Burner - Electric	1272/3	161	Blood Sugar Tube	583	113
Burner - Mecker	1273	161	Wintrobe Tube	585	113
Burner Teclu	1274	161	E.S.R. Tube	587	113
			Wasserman Tube	590	113
			Agglutination Tube	591	113
			Durham Tube	592	114
			Widal Tube	594	114
			Melting Point Tube	595	114
			Micro Capillary Pipettes	595A-595B	114
			End To End Capillary Pipette	595C	114
			Haematocrit Capillaries	595D	115
			Micro Slides	597	115
			Micro Concavity Slides	597A	115
			V.D.R.L. Slides	597B	115
			Counting Chamber	599	115
			Haemocytometer	600	115
			R.B.C. Pipette	601	115
			W.B.C. Pipette	602	115
			Spreader	603B	116
CARBON SULPHUR GLASSWARE			CONDENSERS		
	Cat.No.	Page No.		Cat.No.	Page No.
Absorption Vessel for KOH	911	131	Condensers, Air	125	41
Carbon Burette	912	131	Condensers, Liebig	126	41
Sulphur Burette	915	131	Condensers, Coil, Coil Distillate	127	41
Cooling Condenser	918	131	Condensers, Coil, Jacket Distillate	128	42
Automatic Pippete	919-920	131	Condensers, Coil, Reversible	129	42
Titration Vassel	921	131	Condensers, Double Coil	130	42
View Bulb	925	131	Condensers, Double Surface	131	42
			Condensers, Jacketed Coil	132	43
			Condensers, Inland Revenue	133	43
			Condensers, Allihn (Bulb)	134	43
			Condensers, Friedrich	135	43
			Condensers, Ether	136	43
			Condenser, Cold Finger	137	43
			Condenser, Bulb Shape	145	43
COLUMNS			CONES		
	Cat.No.	Page No.		Cat.No.	Page No.
Columns, Fractionating	301-304	76	Cone, Imhoff, Sharp Tip	93	36
Columns, Packing	305-306	76	Cone, Imhoff, Blunt Tip	94	36
Columns, Chromatography with Disc, Plain	449	93	Stand for Imhoff Cone	94A	36
Columns, Chromatography with Disc, Stopcock	450-452	93-94			
Columns, Chromatography, Plain, with Stpk	454-456	94-95			
Columns, Chromatography, with Reservoir	460-460C	96-97			
Chromatography Sprayer	880	128			
CLAMPS & STANDS					
	Cat.No.	Page No.			
Laboratory Jack	1249	159			
Burette Clamps	1251	159			
Universal Clamps	1252-1253	159			
Finger Clamps (Condenser)	1254	159			
Jumbo Clamps (Condenser)	1255	159			
3 Fingers Clamp Condenser with Silicon Sleeves	1256-1257	160			
Retort Clamps	1258	160			

# INDEX

CYLINDERS			DISSOLUTION BOWL		
	Cat.No.	Page No.		Cat.No.	Page No.
Cylinders, Graduated, Class A	76	31	Dissolution Bowl - Plain	825	123
Cylinders, Graduated, Class A, QR Code	76Q	31	Dissolution Bowl - Amber	826	123
Cylinders, Graduated, NABL	76N	31	<b>DISTILLATION APPRATUS</b>		
Cylinders, Graduated, AMBER	76A	31	Water Distillation, Automatic Cabinet	422	86
Cylinders, Graduated, AMBER-NABL	76AN	32	Water Distillation, NPL Design	425	87
Cylinders, Graduated, USP, Class A	76U	32	Water Distillation, Single Stage	426	88
Cylinders, Graduated, Class B	77	32	Water Distillation, Double Stage	427	89
Cylinders Stopper, Graduated, Class A	78	32	Water Distillation, Double Stage Horizontal	428A	90
Cylinders Stopper, Graduated, NABL	78N	33	Water Still	420	84
Cylinders Stopper, Graduated, Amber	78A	33	Water Still, with Silica Heater, Borosilicate	421	85
Cylinders Stopper, Graduated, Amber, NABL	78AN	33	Water Still, with Silica Heater, Quartz	428	91
Cylinders Stopper, Graduated, Class B	79	33	Water Still, Manesty Type	1209	155
Cylinders, Graduated, Class A-ISI	80	34	Water Softener	429	91
Cylinders, Graduated, R.Base, Class A	81	34	Water Chiller	430	91
Cylinders, Graduated, R.Base, Class B	82	34	<b>DEWAR FLASK</b>		
Cylinders Stopper, Graduated, R.Base, Class A	83	34	Dewar Flask, Unsilvered	873	127
Cylinders Stopper, Graduated, R.Base, Class B	84	35	<b>E</b>		
Cylinder, Rain Measuring	85	35	<b>EXTRACTORS</b>		
Cylinders, Nessler	86-87	35	Soxhlet Extraction	431	92
Cylinders Stopper, Nessler	86A	35	Soxhlet Extraction - with Flange	437	92
Crow Reciever	88-89	35-36	Soxhlet Extraction - Globular Type	438	92
Crow Reciever, Stopper	88A-89A	35-36	Soxhlet Extraction - Aspirator Type	439	92
Cylinder, Sedimentation of Sand	90	36	Soxhlet Extraction - Heating Unit	1195	150
Cylinders, Safety Rider, PP	91	36	<b>ELECTRODES</b>		
Cylinder, Stand, Nessler	1283A 1283B	163	Hoffman's Voltmeter	770	122
<b>D</b>			Platinum Electrodes Pair	772	122
<b>DAIRY &amp; MILK TESTING</b>			Calomel Electrodes	791	122
	Cat.No.	Page No.	Hoffman's Screw Clip	1277	162
Butyrometer	951-955	132	<b>ELECTROPHORESIS</b>		
Mojjonier Flask	957	132	Paper Electrophorsis App.	1301	165
Reichert Wollney's App.	958	132	Immuno Electrophorsis App.	1302	165
Polenske's App.(RM Value)	960	132	Polyacrylamide Gel Electro. App.	1303	165
Lactometer	1011	137	Vertical Slab Gel Electro. App.	1304	165
<b>DESSICATORS</b>			Digital Power Supply Gel Electro.	1305	165
	Cat.No.	Page No.	Paper Electrophorsis	1306	165
Dessicator Plain	881	128	Submarine Gel Electro. App.	1307	165
Dessicator Plain Amber	881A	129	<b>ESSENTIAL OIL DETERMINATION UNIT</b>		
Dessicator Vaccum	882	129	Essential Oil Det. Unit (Clevenger)	475	101
<b>DISHES</b>			Clevenger Assembly, Lighter than Water	476	101
	Cat.No.	Page No.	Clevenger Assembly, Heavier than Water	477	101
Dishes, Crystallizing	834	123			
Dishes, Evaporating	835	123			
Dishes, Petriplate	603	115			
Dishes, Petriplate - Amber	603-A	116			
Drying Trays	891	130			

# F

# INDEX

FLASK BOILING			FUNNELS		
	Cat.No.	Page No.		Cat.No.	Page No.
Flask, Reaction	161	44	Funnel Separating, Glass Stpk	280A	70
Flask, Reaction, Lid	162	44	Funnel Separating, Glass Stpk, Amber	280B	70
Flask, Reaction, SS Clip	163	44	Funnel Separating, Rotaflow Stpk	281	70
Flask, Reaction, Teflon Gasket	164	44	Funnel Separating, PTFE Stpk	282	71
Flasks, Boiling Round Bottom	188	57	Funnel Separating, PTFE Stpk, Amber	282A	71
Flasks, Boiling Round Bottom, Amber	188A	57	Funnel Separating, Globe Shape	283-285	71-72
Flasks, Boiling Flat Bottom	189	57	Funnel Dropping	286-291	72-73
Flasks, Boiling Flat Bottom, Amber	189A	58	Funnel Separating, Globe Shape, with Cone	292-293	73
Flasks, Boiling Round Bottom, I/C Joint, Amber	165A	44	Funnel Pressure Equalising	296-299	74-75
Flasks, Boiling Flat Bottom, I/C Joint, Amber	165B	44	Funnel Filtering 60° Stem	868	127
Flasks, Boiling Round Bottom, I/C Joint	165	45	Funnel Powder	868A	127
Flasks, Boiling Flat Bottom, I/C Joint	165F	46	Funnel Powder with Cone	868B	127
Flasks, Boiling Round Bottom, Parallel, 2 Neck	166P	47	Funnel Thistle	870	127
Flasks, Boiling Round Bottom, Angle, 2 Neck	166A	48			
Flasks, Boiling Round Bottom, Angle, 3 Neck	167P	49			
Flasks, Boiling Round Bottom, Parallel, 3 Neck	167A	50			
Flasks, Boiling Round Bottom, Angle, 4 Neck	167B	51			
Flasks, Boiling Round Bottom, Parallel, 4 Neck	167C	52			
Flasks, Rotary Evaporators	168A				
FLASK CONICAL			GLASSWARE FOR GASES		
	Cat.No.	Page No.		Cat.No.	Page No.
Flask Conical, Graduated	183	56	Gas Desorber	661	117
Flask Conical, Graduated, Amber	183A	56	Impinger	662-664	117-118
Flask Conical, Screw Cap	180	55	Calcium Chloride Tube	671-674	118
Flask, Conical, I/C Joint	168	52	Calcium Chloride Tower	678	118
Flask, Conical, I/C, Stoppered	181	55	Tupwiler Gas Burette	679	118
Flask, Conical, I/C, Stoppered, Amber	181A	55	Bunte Gas Burette	680	118
Flask, Iodine	182	55	Hample Gas Burette	681	118
Flask, Filtering, Bolt Neck	179	54	Gas Collecting Tubes	688-691	119
Flask, Filtering, Bolt Neck, I/C Joint	169	53	Gas Washing Bottle	692-695	120
Flask, Kjeldahl, Plain	184	56	Gas Jar	696	120
Flask, Kjeldahl, I/C Joint	170	53	Gas Generator - Kipp's	697	120
Flask, Pear Shape	171-173	53	Oxygen Deter. App.	700	120
Flask, Pear Shape, Vigreus	174-175	54			
Flask, Pear Shape, Distillation	176-177	54			
Flask, Distillation, with Side Tube	178	54			
Flask, Conical, Long Neck	185	56			
Flask, Conical, Wide Mouth	186	56			
Flask, Haffkine, Culture	190	58			
Flask, Cleaning Brush	191	58			
Micro Combustion Flask (Oxygen Flask)	831	123			
			ORSAT GAS ANALYSIS		
	Cat.No.	Page No.		Cat.No.	Page No.
			Orsat Gas Analysis - 3 Pipettes	705-707	121
			Orsat Gas Analysis - 4 Pipettes	711-713	121
			Orsat Gas Analysis - 5 Pipettes	714-716	121
			Orsat Gas Analysis - Spares	720	121
			HYDROMETERS		
	Cat.No.	Page No.		Cat.No.	Page No.
			Hydrometers, Specific Gravity	1001	136
			Hydrometers, Universal	1002	136
			Hydrometers, Beaume	1003-1005	136
			Hydrometers, Brix	1006-1007	136-137
			Hydrometers, Ske's	1008	137
			Hydrometers, Twaddle	1009	137
			Hydrometers, Density	1015	137

# G

# H

# INDEX

INTERCHANGEABLE GLASS ASSEMBLIES	Cat.No.	Page No.	LABORATORY INSTRUMENTS	Cat.No.	Page No.
Phenol Distillation App.	341	81	Rotary Vacuum Evaporator	1187-1188	148
Ammonia Distillation App.	344	81	Heating Mantles	1196	151
Reflux Assemblies	345-349	81	Hot Plates	1197	152
Reaction Assemblies	350-351	81	Laboratory Stirrer	1198	152
Alcohol Distillation Unit	354	82	Magnetic Stirrer	1199	152
Preparation Assemblies	356	82	Water Bath Serological	1200	152
Kjeldahl Distillation Asmb.	358-359	82	Water Bath Double Walled	1201	153
Steam Distillation Asmb.	363-365	82	Precision Water Bath	1201A	153
Sublimation Distillation Asmb.	366	82	Water Bath Incubator Shaker	1201B	153
Solvent Recovery Asmb.	369-372	83	Water Bath Universal	1203	153
Fractionation Assembly	373-375	83	Cylindrical Oil Bath	1205	154
Mercury Distillation Asmb.	386	83	Melting Point App.	1206	154
Carbaryl Content Det. App.	393	83	Oven Universal	1210	155
Cyanide Dist. App.	395	84	Incubator Universal	1224	156
Mancozeb Content App.	396	84	B.O.D. Incubator	1225	156
Sulfur Dioxide Asmb.	397	84	Autoclave Vertical	1226	157
Congeaing Temp. App.	398T	84	Vortex Shaker	1228	157
Hydroxypropoxy Det. App.	399	84	V.D.R.L. Shaker	1229	157
Methoxy Det. Asmb.	400	84	C.O.D. Digestion App.	1230	157
Utility Sets	401-403	84	Rotary Shaker	1231	157
			Ultrasonic Cleaner (Sonicator)	1236	158
			Muffle Furnance	1240D	158
			Vacuum Oven	1241	158
			Centrifuge Machine	1245	158

## J

JARS	Cat.No.	Page No.
Jar, Specimel	883	129
Jar, Rectangular - Boro3.3	889	130
Jar, Rectangular - Neutral Glass	890	130
Jar, SS Lid	890A	130
Jar, Anaerobic Culcture	1141-1146	144

## K

KJELDHAL APPARTUS	Cat.No.	Page No.
Combined - Digestion & Distillation	1190	149
Kjeldhal Digestion Unit	1191-1192	149-150
Kjeldhal Distillation Unit	1194	150

## L

LIQUID HANDLING	Cat.No.	Page No.
Micropipettes, Variable	1401	170
Micropipettes, Variable, NABL	1401N	170
Micropipette Fixed Volume	1402	171
Micropipette, Multichannel	1403	171
Micropipette, Tips	1404	171
Micropipette, Stand	1405	171
Bottle Top Dispensers	1411	172

## M

MOISTURE DETERMINATION	Cat.No.	Page No.
Moisture Determination Unit with STPK	465	99
Moisture Determination Unit with STPK, NABL	465N	99
Moisture Determination Unit	466	99
Moisture Determination Unit, NABL	466N	99
Soil Moisture Gauge	469	100

## N

NITROGEN DETERMINATION ASSEMBLIES	Cat.No.	Page No.
Macro Kjeldahl Distillation	481	102
Micro Nitrogen Distillation (Lourquin App.)	483	102
Semi Micro Kjeldahl Unit	484	102
Micro Kjeldahl Nitrogen Dist. Unit	485	102
Markham Semi Micro Dist. Unit	489	102
Nitrogen Distillation Asmb.	490	102

# P

# INDEX

PIPETTES			PTFE LABWARE		
	Cat.No.	Page No.		Cat.No.	Page No.
Pipettes, Transfer Volumetric-ISI	35	10	PTFE, Stopper	1151	145
Pipettes, Transfer Volumetric-Class A	36	10	PTFE, Stirring Bar	1152	145
Pipettes, Transfer Volumetric-NABL	36N	10	PTFE, Stirring Bar - Oval Shape	1152A	145
Pipettes, Transfer Volumetric-QR Code	36Q	11	PTFE, Beaker	1153	145
Pipettes, Transfer Volumetric-Amber	36A	11	PTFE, Beaker, Lids	1154	145
Pipettes, Transfer Volumetric-Amber-NABL	36AN	11	PTFE, Bottle	1155	146
Pipettes, Transfer Volumetric-Class B	37	11	PTFE, Centrifuge Tube	1156	146
Pipettes, Transfer Volumetric-USP	38	12	PTFE, Reduction Adapter	1160	146
Pipettes, Transfer Volumetric-USP-QR	38Q	12	PTFE, Expansion Adapter	1161	146
Pipettes, Measuring, Serological-Class A	39	12	PTFE, Magnet Retriever	1162	146
Pipettes, Measuring, Serological-NABL	39N	13	PTFE, Stirrer Rod	1163	146
Pipettes, Measuring, Serological-Amber Class A	39A	13	PTFE, Stirrer Scraper	1165	146
Pipettes, Measuring, Serological-Amber-NABL	39AN	13	PTFE, Stuffing Box Gland	1166	146
Pipettes, Measuring, Serological-USP	39U	13			
Pipettes, Measuring, Serological-Class B	40	14			
Pipettes, Measuring, Mohr Type-Class A	41	14			
Pipettes, Measuring, Mohr Type-NABL	41N	14			
Pipettes, Measuring, Mohr Type-Amber-NABL	41AN	15			
Pipettes, Measuring, Mohr Type-Class B	42	15			
Pipettes, Automatic	45-48	15-16			
Pipettes, Milk Testing	49-51	16			
Pipette, Alcohol	52	16			
Pipette, E.S.R	53	16			
Pipette, Drum Sampling	54	16			
Pipette, Mechanical	56	17			
Pipette, Artificial Insemination	57	17			
Pipette, Pasteur	58	17			
Pipette, Silicon Filler (Bulb)	59	17			
Pipette, Can	1285	164			
Pipette Washer, Automatic	1207	155			
PLANT PHYSIOLOGY			QUARTZ LABWARE		
	Cat.No.	Page No.		Cat.No.	Page No.
Root Pressure App.	1120	144	Quartz, Beaker	1071	140
High Pressure Manometer	1121	144	Quartz, Boiling Flask	1072	140
Osmotic Pressure App.	1122	144	Quartz, Conical Flask	1073	141
Potometer	1124	144	Quartz, Volumetric Flask	1074	141
Respirometer	1129	144	Quartz, Measuring Cylinder	1075	141
Fermentation Vessel	1130	144	Quartz, Pipettes Transfer Volumetric	1076	141
Willmout Bubbler	1133	144	Quartz, Cuvette	1077	141
			Quartz, Basins	1079	141
			Quartz, Test Tube	1080	141
			Quartz, Combustion Boat	1081	142
			Quartz, Reagent Bottle	1083	142
			Quartz, Crucible	1085	142
			Quartz, Crucible Lid	1085L	142
			Quartz, Gooch Type Crucible	1086	142
			Quartz, Funnel Filtering	1087	142
PORCELAIN WARE			RUBBER & SILICON LABWARE		
	Cat.No.	Page No.		Cat.No.	Page No.
Agate Motor & Pestle	1061	139	Rubber Cone	1328	168
Porcelain, Buchner Funnel	1062	139	Rubber Corks	1329	168
Porcelain, Crucible	1063	140	Rubber Pipette Bulb	1335	169
Porcelain, Evaporatin Dish	1064	140	Rubber Sheets	1345	169
Alumina, Crucible	1065	140	Rubber Teat	1338	169
			Rubber Tubing- High Pressure	1322	166
			Rubber Tubing- Soft	1320	166
			Rubber-Vacuum Tube	1324V	166
			Silicon Flask Stand	1343	169
			Silicon Pipette Bulb	1344	169
			Silicon Pipette Filler (Propitor)	1339	169
			Silicon- Police man	1330	169
			Silicon Rubber Cork	1325	167
			Silicon Rubber Cork for Filter Flask	1346	169
			Silicon Rubber Tubing	1324	166
			Silicon Spreader	1342	169
			Turn Over Flange - For Sockets	1326A	167
			Turn Over Flange - For Test Tubes	1326	167

# Q

# R

## S

## INDEX

<b>SILICA LABWARE</b>			<b>THERMOMETERS</b>		
	<b>Cat.No.</b>	<b>Page No.</b>		<b>Cat.No.</b>	<b>Page No.</b>
Sillica Curcible With Lid	1091	143	Thermometers, Mercury Filled	971	133
Sillica Curcible Without Lid	1092	143	Thermometers, NABL	971N	133
Sillica Basin	1093	143	Thermometers, Red spirit Filled	971A	133
			Thermometers, Red spirit Filled, NABL	971AN	133
			PTFE Cone for Thermometers	972	133
			Precesion Thermometers	973	133
			Precesion Thermometers, NABL	973N	134
			Thermometers with Cone	974	134
			Thermometers with Cone, NABL	974N	134
			Immersion Thermometers	975	134
			Immersion Thermometers, NABL	975N	134
			Low Temp. Thermometers	976	135
			Oven/Incubator Thermometers	977	135
			Oven/Incubator Thermometers, NABL	977N	135
			Wall Thermometer	983	135
			Clinical Thermometer	987	135
			Soil Thermometer	990	135
<b>SINTERED GLASSWARE</b>			<b>TISSUE HOMOGENISERS</b>		
	<b>Cat.No.</b>	<b>Page No.</b>		<b>Cat.No.</b>	<b>Page No.</b>
Filter App., Witts	325	77	Tissue Grinders- Ten Broeck Type	631	116
Sintered, Crucible Gooch	328	77	Tissue Grinders	632	116
Sintered, Buchner Funnel	329-330	78	Tissue Homog. with PTFE Pestle	633	116
Membrane Filters Holder, Std. Fitting	331	78	Spare Glass Vessel	634	116
Membrane Filters Holder, Rubber Fitting	332	79			
Membrane Filters Holder, Stainless Steel	332A	79			
Sintered, Tube Sealed	333	80			
Sintered, Conical Filter	334	80			
Sintered, Glass Filter Tube	335	80			
<b>SPATULA</b>			<b>TUBES</b>		
	<b>Cat.No.</b>	<b>Page No.</b>		<b>Cat.No.</b>	<b>Page No.</b>
Spatula - Flat & Spoon	1279	162	Tubes, Culture Media, Round Bottom	95	37
Spatula Wire Type	1279A	162	Tubes, Culture Media, Round Bottom, Amber	95A	37
Forceps - Fine Point	1279F	162	Tubes, Culture Media, Flat Bottom	97	37
			Tubes, Culture Media, Flat Bottom, Amber	97A	37
			Tubes, Leighton	100-101	37
			Tubes, Centrifuge, Graduated	102	38
			Tubes, Centrifuge, Plain	103	38
			Tubes, Centrifuge, Screw Cap	104	38
			Tubes, Centrifuge, Screw Cap, Grad.	105	38
			Tubes, Centrifuge, Stoppered	106	38
			Tubes, Centrifuge, Stoppered, Grad.	107	38
			Tubes, Centrifuge, Round Bottom, Grad.	108	39
			Tubes, Centrifuge, Oil, Graduated	110-112	39
			Test Tubes, Stoppered, Graduated	114	39
			Test Tubes, Stoppered	115	39
			Test Tubes, With Rim, Borosilicate Glass	116	40
			Test Tubes, Rimless, Borosilicate Glass	116A	40
			Test Tubes, Graduated	117	40
			Test Tube, Rubber Cork	118	40
			Test Tube, Stands, Aluminium	1282	163
			Test Tube, Stands, Stainless Steal	1282 SS	163
			Test Tube, Stands, Wire	1282 W	163
			Tubes, Polarimeter	871-872	127
<b>STIRRERS</b>					
	<b>Cat.No.</b>	<b>Page No.</b>			
Stirrer, Plain	260	68			
Stirrer, Teflon Bladed	261	68			
Stirrer, Link	262	69			
Stirrer, Collapsible Paddle	263	69			
Stirrer, Fixed Paddle	264	69			
Stirrer, Semi Micro	267	69			
Stirrer, Guides	268	69			
Gland, Mercury Seal	269	69			
Gland, Mercury Seal, Cap	270	69			
Gland, Stuffing Box, Brass Pulley	271	69			
Gland, Simple with Cap	272	69			
<b>STOPCOCKS</b>					
	<b>Cat.No.</b>	<b>Page No.</b>			
Stopcock Glass Key	501-511	103			
Stopcock Screw Type Two Limbs	517	104			
Stopcock PTFE Key	525-531	104			
Stopcock High Vacuume	536-545	105			
<b>STOPPERS</b>					
	<b>Cat.No.</b>	<b>Page No.</b>			
Stoppers, Polypropylene	207	60			
Stoppers, Hollow	210	61			
Stoppers, Hollow Amber	210A	61			
Stoppers, Solid Penny Head	211	61			
Stoppers, Flat Head	211A	61			
Stoppers, Flat Head Amber	212	62			
<b>TAPS</b>					
	<b>Cat.No.</b>	<b>Page No.</b>			
Swan Neck Tap	1280	162			
Gas Tap	1281	163			

## T

# V

# INDEX

VIALS			VOLUMETRIC FLASK		
	Cat.No.	Page No.		Cat.No.	Page No.
Vials, Screw Cap, Clear Glass	461	98	Flask, Volumetric, PTFE Stopper Class A	62P	19
Vials, Screw Cap, Amber Glass	461A	98	Flask, Volumetric, PTFE Stopper Class A, Amber Colour	62AP	20
Vials, WRS, Screw Cap, Amber Glass	461B	98	Flask, Volumetric, PTFE Stopper USP, Class A	63ASTM	24
Vials, Crimp Neck, Clear Glass	462	98	Flask, Volumetric, PTFE Stopper USP, Class A, Amber Colour	63ASTMA	26
Vials, Crimp Neck, Amber Glass	462A	98	Flask, Volumetric, Wide Mouth-Colour Coded	63WC	27
Vial, Crimping Tool	463	99	Flask, Volumetric, Wide Mouth- Amber	63WA	27
Vial, Decrimping Tool	463A	99	Flask, Volumetric , Wide Mouth- Amber-Colour Coded	63WAC	27
Vials, HPLC	464	99	Flask, Volumetric , Class B	64	28
Vials, Storage Cabinet	461C	98	Flask, Volumetric, Wide Mouth - USP - Class A	65UW	28
			Flask, Volumetric, Wide Mouth - USP Amber- Class A	65UWA	29
			Flask, Sugar Estimation	66-67	29
			Flasks, Kohlrash (Mud Flask)	68-69	29
			Flask, Saybolt Viscosity	70	29
			Flask, Cassia	71	29
			Flask, Lechatelier	72-73	29
			Flask, Sulphonation	74	29
			Flask, Jar, Petroleum	75	29
			Flask, Weight Rings	75A	30
			Flask, Silicon Safety Riders	75B	30
			Flask, Cleaning Brush	75C	30
VISCOMETERS			W		
	Cat.No.	Page No.	WEIGHT BOX		
Viscometer, Ostwald	850	124		Cat.No.	Page No.
Viscometer, U- Tube	850A	124	Weight Box - Analytical	1290	164
Viscometer, Suspended Level	850B	124	Weight Box - Physical	1292	164
Viscometer, U-Tube Reverse Flow	850C	124	Weights Analytical Fractional	1294	164
Viscometer, Canon -Fenske, Direct	850D	125			
Viscometer, Canon -Fenske, Reverse	850F	125			
Viscometer, Ubbelohde	850G	125			
VOLUMETRIC FLASK					
	Cat.No.	Page No.			
Flask, Volumetric , ISI Marked	61	18			
Flask, Volumetric , Class A	62	18			
Flask, Volumetric, NABL	62N	19			
Flask, Volumetric, QR Code	62Q	19			
Flask, Volumetric, Colour Coded	62C	20			
Flask, Volumetric, QR Code + Colour Coded	62QC	20			
Flask, Volumetric, Amber-Class A	62A	21			
Flask, Volumetric, Amber-NABL	62AN	21			
Flask, Volumetric, Amber-QR Code	62AQ	22			
Flask, Volumetric, Amber-Colour Coded	62AC	22			
Flask, Volumetric, Amber- QR Code + Colour Coded	62AQC	22			
Flask, Volumetric, USP - Class A	63U	23			
Flask, Volumetric, USP - QR Code	63UQ	23			
Flask, Volumetric, USP - Colour Coded	63UC	23			
Flask, Volumetric, USP- QR Code + Colour Coded	63UQC	24			
Flask, Volumetric, USP - Amber	63UA	24			
Flask, Volumetric, USP - Amber-QR Code	63UAQ	25			
Flask, Volumetric, USP - Amber-Colour Coded	63UAC	25			
Flask, Volumetric, USP - Amber-QR Code + Colour Code	63UAQC	25			
Flask, Volumetric, Wide Mouth - Class A	63W	26			
Flask, Volumetric, Wide Mouth - NABL	63WN	26			

## TERMS OF BUSINESS

- PRICES** : All the prices in the list are Ex-works Ambala and subject to market fluctuation and alteration without notice.
- PACKING & FORWARDING** : Packing, Forwarding, Freight, Insurance and Other Incidental Charges extra.
- BREAKAGE** : Every possible care is taken in packing. The company is not liable for any breakage, shortage and damage in transit. All the goods are supplied at purchaser's risk.
- INSURANCE** : Since goods are Fragile in nature, transit insurance may be made at an extra cost.
- GST** : GST will be charged extra as applicable.
- PAYMENTS** : R.R./G.R./Docket and our bill will be sent through any scheduled bank or on COD basis New customers are requested to send draft for 25% amount of the estimated value of order as an advance.
- ORDERS** : All order must accompany with full instructions for despatch, viz. the name and address of the Bank/Cargo through which the documents are to be sent. Please always mention our catalogues, number with brief description while placing your value order.
- DELIVERY** : Whereever possible we shall effet immediate delivery, otherwise 4-8 weeks time will be required to execute the order. In case of unavoidable circumstances, company is not bound to execute the order.
- DISPUTES** : All disputes are subject to Ambala Jurisdiction.

**THIS CANCELS OUR ALL PREVIOUS PRICE LISTS.**

# NABL Certified Thermometers

## VOLUMETRIC & GRADUATED GLASSWARE

- Burettes
- Measuring Pipettes
- Graduated Pipettes
- Volumetric Flask
- Measuring Cylinders





## Volumetric / Graduated Glassware - BURETTES

- 1 Burettes with Pinch Cock "JSGW", Rubber tubing and glass jet. Accuracy as per Class 'B'.

Cat. No.	Capacity ml.	Sub. Div. ml.	Tolerance $\pm$ ml.	Minimum Qty/Pack	Price/Piece (₹)
1/1	**10	0.05	0.05	10	365.00
1/2	25	0.1	0.1	10	335.00
1/3	50	0.1	0.1	10	340.00
1/4	100	0.2	0.2	10	350.00

- 2 Burettes with Straight Bore Glass Key, with Screw Thread, O-Ring Stopcock "JSGW", Accuracy as per Class 'A', with Individual works certificate.

Cat. No.	Capacity ml.	Sub. Div. ml.	Tolerance $\pm$ ml.	Minimum Qty/Pack	Price/Piece (₹)
2/1	**1	0.01	0.006	4	1900.00
2/2	**2	0.01	0.01	4	1900.00
2/3	**5	0.02	0.01	4	1700.00
2/4	**10	0.05	0.03	4	1710.00
2/5	25	0.1	0.05	4	1270.00
2/5 	25	0.1	0.05	4	1995.00
2/5-1	25	0.05	0.03	2	1545.00
2/6	50	0.1	0.05	4	1290.00
2/6 	50	0.1	0.05	4	2190.00
2/7	100	0.2	0.1	4	1320.00

- 2 N Burettes with Straight Bore Glass Key, with Screw Thread, O-Ring Stopcock "JSGW", Accuracy as per Class 'A', with NABL works certificate.

Cat. No.	Capacity ml.	Sub. Div. ml.	Tolerance $\pm$ ml.	Minimum Qty/Pack	Price/Piece (₹)
2N/1	**1	0.01	0.006	2	2960.00
2N/2	**2	0.01	0.01	2	2960.00
2N/3	**5	0.02	0.01	2	2960.00
2N/4	**10	0.05	0.03	2	2825.00
2N/5	25	0.1	0.05	2	2750.00
2N/6	50	0.1	0.05	2	2825.00
2N/7	100	0.2	0.1	2	2815.00

- 2A Amber Colour Burettes, "JSGW", with Screw Thread, O-Ring Stopcock Accuracy as per Class 'A', with Individual works certificate.

Cat. No.	Capacity ml.	Sub Div. ml.	Tolerance $\pm$ ml.	Minimum Qty/Pack	Price/Piece (₹)
2A/1	*1	0.01	0.006	4	2775.00
2A/2	*2	0.01	0.01	4	2775.00
2A/3	*5	0.02	0.01	4	2775.00
2A/4	*10	0.05	0.03	4	2775.00
2A/5	25	0.1	0.05	4	2525.00
2A/6	50	0.1	0.05	4	2560.00
2A/7	100	0.2	0.1	4	2645.00

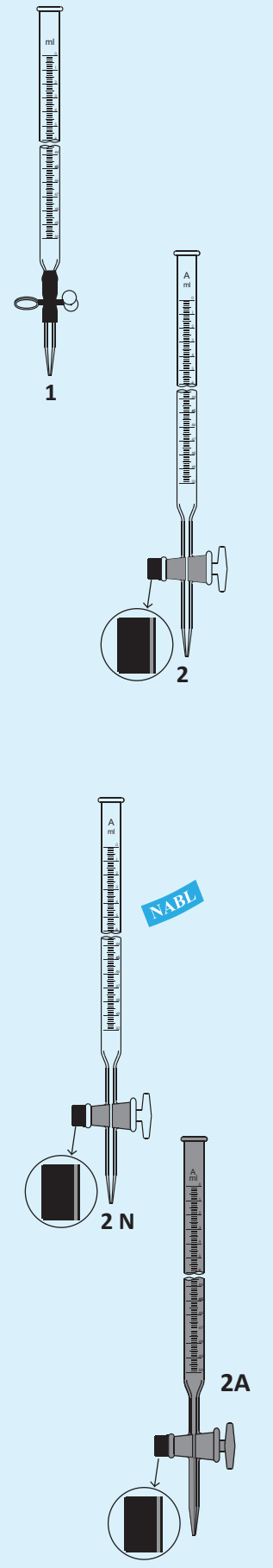

\*\* With Cup Top

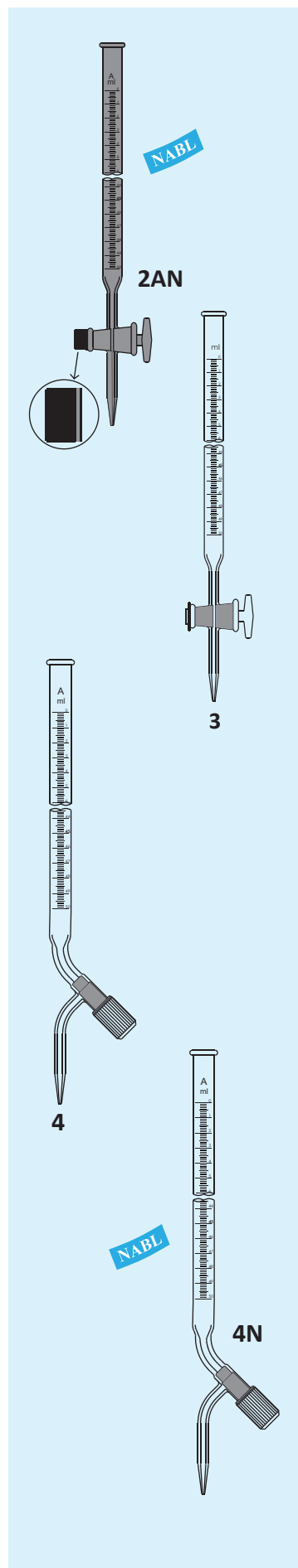



**2AN Amber Colour Burettes, "JSGW", with Screw Thread, O-Ring Stopcock**  
Accuracy as per **Class 'A'**, with **NABL** works certificate.

Cat. No.	Capacity ml.	Sub Div. ml.	Tolerance $\pm$ ml.	Minimum Qty/Pack	Price/Piece ( )
2AN/1	*1	0.01	0.006	2	4030.00
2AN/2	*2	0.01	0.01	2	4030.00
2AN/3	*5	0.02	0.01	2	4030.00
2AN/4	*10	0.05	0.03	2	4030.00
2AN/5	25	0.1	0.05	2	3580.00
2AN/6	50	0.1	0.05	2	3675.00
2AN/7	100	0.2	0.1	2	3660.00

**3 Burettes with Straight Bore Glass Key Stopcock "JSGW", Accuracy as per Class 'B'**

Cat. No.	Capacity ml.	Sub. Div. ml.	Tolerance $\pm$ ml.	Minimum Qty/Pack	Price/Piece ( )
3/1	**1	0.01	0.01	6	1225.00
3/2	**2	0.01	0.02	6	1225.00
3/3	**5	0.02	0.02	6	1060.00
3/4	**10	0.05	0.05	6	780.00
3/5	25	0.1	0.1	10	590.00
3/6	50	0.1	0.1	10	610.00
3/7	100	0.2	0.2	6	740.00

**4 Burettes with Screw Type PTFE Needle Valve Stopcock "JSGW", Accuracy as per Class 'A', with Individual works certificate.**

Cat. No.	Capacity ml.	Sub. Div. ml.	Tolerance $\pm$ ml.	Minimum Qty/Pack	Price/Piece ( )
4/1	**1	0.01	0.006	2	2160.00
4/2	**2	0.01	0.01	2	2160.00
4/3	**5	0.02	0.01	2	1935.00
4/4	**10	0.05	0.03	2	1710.00
4/5	25	0.1	0.05	2	1225.00
4/5 	25	0.1	0.05	2	1995.00
4/5-1	25	0.05	0.03	1	1515.00
4/6	50	0.1	0.05	2	1265.00
4/6 	50	0.1	0.05	2	2190.00
4/7	100	0.2	0.1	2	1285.00

**4 N Burettes with Screw Type PTFE Needle Valve Stopcock "JSGW", Accuracy as per Class 'A', with NABL works certificate.**

Cat. No.	Capacity ml.	Sub. Div. ml.	Tolerance $\pm$ ml.	Minimum Qty/Pack	Price/Piece ( )
4N/1	**1	0.01	0.006	2	2960.00
4N/2	**2	0.01	0.01	2	2960.00
4N/3	**5	0.02	0.01	2	2960.00
4N/4	**10	0.05	0.03	2	2825.00
4N/5	25	0.1	0.05	2	2750.00
4N/6	50	0.1	0.05	2	2825.00
4N/7	100	0.2	0.1	2	2815vv.00

\*\* With Cup Top

5 Burettes with Screw Type PTFE Needle Valve Stopcock "JSGW", Accuracy as per Class 'B'.

Cat. No.	Capacity ml.	Sub. Div. ml.	Tolerance $\pm$ ml.	Minimum Qty/Pack	Price/Piece (₹)
5/1	**1	0.01	0.01	6	1225.00
5/2	**2	0.01	0.02	6	1225.00
5/3	**5	0.02	0.02	6	1225.00
5/4	**10	0.05	0.05	6	790.00
5/5	25	0.1	0.1	10	590.00
5/6	50	0.1	0.1	10	610.00
5/7	100	0.2	0.2	6	740.00

6 Burettes with Straight Bore PTFE key Stopcock "JSGW", Accuracy as per Class 'A', with works certificate.

Cat. No.	Capacity ml.	Sub. Div. ml.	Tolerance $\pm$ ml.	Minimum Qty/Pack	Price/Piece (₹)
6/1	**1	0.01	0.006	4	2515.00
6/2	**2	0.01	0.01	4	2515.00
6/3	**5	0.02	0.01	4	2295.00
6/4	**10	0.05	0.03	4	1990.00
6/5	25	0.1	0.05	4	1520.00
6/5-1	25	0.05	0.03	2	1790.00
6/6	50	0.1	0.05	4	1535.00
6/7	100	0.2	0.1	4	1565.00

6 N Burettes with Straight Bore PTFE key Stopcock "JSGW", Accuracy as per Class 'A' with NABL works certificate.

Cat. No.	Capacity ml.	Sub. Div. ml.	Tolerance $\pm$ ml.	Minimum Qty/Pack	Price/Piece (₹)
6N/1	**1	0.01	0.006	2	3310.00
6N/2	**2	0.01	0.01	2	3310.00
6N/3	**5	0.02	0.01	2	3310.00
6N/4	**10	0.05	0.03	2	3160.00
6N/5	25	0.1	0.05	2	3160.00
6N/6	50	0.1	0.05	2	3160.00
6N/7	100	0.2	0.1	2	3310.00

6A Amber Colour Burettes, "JSGW", with Straight Bore PTFE Key Stopcock, Accuracy as per Class 'A', with Individual works certificate.

Cat. No.	Capacity ml.	Sub Div. ml.	Tolerance $\pm$ ml.	Minimum Qty/Pack	Price/Piece (₹)
6A/1	*1	0.01	0.006	2	2960.00
6A/2	*2	0.01	0.01	2	3040.00
6A/3	*5	0.02	0.01	2	3040.00
6A/4	*10	0.05	0.03	2	3040.00
6A/5	25	0.1	0.05	2	2815.00
6A/6	50	0.1	0.05	2	2980.00
6A/7	100	0.2	0.1	2	3270.00

\*\* With Cup Top

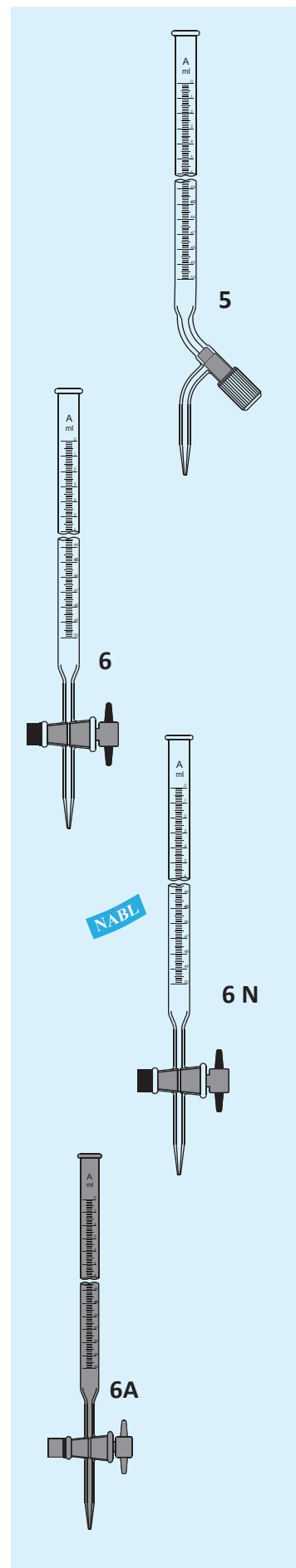

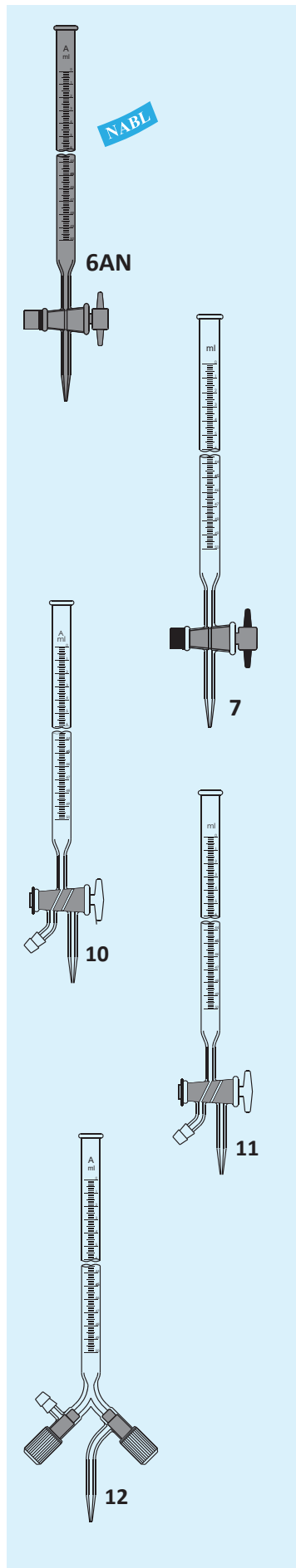

**6AN** Amber Colour Burettes, "JSGW", with Straight Bore PTFE Key Stopcock. Accuracy as per **Class 'A'**, with **NABL** works certificate.

Cat. No.	Capacity ml.	Sub Div. ml.	Tolerance $\pm$ ml.	Minimum Qty/Pack	Price/Piece (₹)
6AN/1	*1	0.01	0.006	2	4480.00
6AN/2	*2	0.01	0.01	2	4480.00
6AN/3	*5	0.02	0.01	2	4480.00
6AN/4	*10	0.05	0.03	2	4480.00
6AN/5	25	0.1	0.05	2	4090.00
6AN/6	50	0.1	0.05	2	4090.00
6AN/7	100	0.2	0.1	2	4270.00

**7** Burettes with Straight Bore PTFE Key Stopcock "JSGW", Accuracy as per **Class 'B'**.

Cat. No.	Capacity ml.	Sub. Div. ml.	Tolerance $\pm$ ml.	Minimum Qty/Pack	Price/Piece (₹)
7/1	**1	0.01	0.01	6	1565.00
7/2	**2	0.01	0.02	6	1565.00
7/3	**5	0.02	0.02	6	1565.00
7/4	**10	0.05	0.05	6	1265.00
7/5	25	0.1	0.1	10	960.00
7/6	50	0.1	0.1	10	970.00
7/7	100	0.2	0.2	6	1120.00

**10** Burettes, Double Oblique Bore Glass Key Stopcock, 3-way,"JSGW", Accuracy as per **Class 'A'**, with works certificate.

Cat. No.	Capacity ml.	Sub. Div. ml.	Tolerance $\pm$ ml.	Minimum Qty/Pack	Price/Piece (₹)
10/1	10	0.05	0.02	2	1600.00
10/2	25	0.1	0.05	2	1430.00
10/3	50	0.1	0.05	2	1450.00
10/4	100	0.2	0.01	2	1515.00

**11** Burettes, Double Oblique Bore Glass Key Stopcock, 3-way,"JSGW", Accuracy as per **Class 'B'**.

Cat. No.	Capacity ml.	Sub. Div. ml.	Tolerance $\pm$ ml.	Minimum Qty/Pack	Price/Piece (₹)
11/1	10	0.05	0.05	2	855.00
11/2	25	0.1	0.1	2	800.00
11/3	50	0.1	0.1	2	810.00
11/4	100	0.2	0.2	2	925.00

**12** Burettes, Three Way Bore Screw type PTFE Needle Valve Stopcock, "JSGW" Accuracy as per **Class 'A'**, with works certificate.

Cat. No.	Capacity ml.	Sub. Div. ml.	Tolerance $\pm$ ml.	Minimum Qty/Pack	Price/Piece (₹)
12/1	10	0.05	0.02	2	1665.00
12/2	25	0.1	0.05	2	1625.00
12/3	50	0.1	0.05	2	1665.00
12/4	100	0.2	0.1	2	1775.00

**Note** : 1 ml., 2 ml. & 5 ml. Burettes corresponding to Cat. Nos. 10 to 12 can also be supplied at the prices of 10 ml. Burettes in respective Cat. Nos.

- 13 Burettes, Three Way Bore Screw type PTFE Needle Valve Stopcock, "JSGW" Accuracy as per **Class 'B'**.

Cat. No.	Capacity ml.	Sub. Div. ml.	Tolerance $\pm$ ml.	Minimum Qty/Pack	Price/Piece (₹)
13/1	10	0.05	0.05	2	1110.00
13/2	25	0.1	0.1	2	1040.00
13/3	50	0.1	0.1	2	1110.00
13/4	100	0.2	0.2	2	1270.00

- 14 Burettes, Double Oblique Bore PTFE Key Stopcock, 3-way, "JSGW", Accuracy as per **Class 'A'**, with works certificates.

Cat. No.	Capacity ml.	Sub. Div. ml.	Tolerance $\pm$ ml.	Minimum Qty/Pack	Price/Piece (₹)
14/1	10	0.05	0.02	2	2380.00
14/2	25	0.1	0.05	2	2380.00
14/3	50	0.1	0.05	2	2425.00
14/4	100	0.2	0.1	2	2500.00

- 15 Burettes, Over Flow Cup, Automatic Zero, Double Oblique Bore Glasskey Stopcock, 3-way, "JSGW", Accuracy as per **Class 'A'**, with works certificate.

Cat. No.	Capacity ml.	Sub. Div. ml.	Tolerance $\pm$ ml.	Minimum Qty/Pack	Price/Piece (₹)
15/1	10	0.05	0.02	2	2435.00
15/2	25	0.1	0.05	2	2435.00
15/3	50	0.1	0.05	2	2485.00
15/4	100	0.2	0.1	2	2665.00

- 16 Burettes, Over Flow Cup, Automatic Zero, Double Oblique Bore Glasskey Stopcock, 3-way, "JSGW", Accuracy as per **Class 'B'**.

Cat. No.	Capacity ml.	Sub. Div. ml.	Tolerance $\pm$ ml.	Minimum Qty/Pack	Price/Piece (₹)
16/1	10	0.05	0.05	2	1570.00
16/2	25	0.1	0.1	2	1570.00
16/3	50	0.1	0.1	2	1675.00
16/4	100	0.2	0.2	2	1770.00

- 17 Burettes, Over Flow Cup, Automatic Zero, 3 ways Screw type PTFE Needle Valve Stopcock, "JSGW", Accuracy as per **Class 'A'**, with works certificate.

Cat. No.	Capacity ml.	Sub. Div. ml.	Tolerance $\pm$ ml.	Minimum Qty/Pack	Price/Piece (₹)
17/1	10	0.05	0.02	2	2320.00
17/2	25	0.1	0.05	2	2320.00
17/3	50	0.1	0.05	2	2365.00
17/4	100	0.2	0.1	2	2550.00

- 18 Burettes, Over Flow Cup, Automatic Zero, 3 ways Screw type PTFE Needle Valve Stopcock, "JSGW", Accuracy as per **Class 'B'**.

Cat. No.	Capacity ml.	Sub. Div. ml.	Tolerance $\pm$ ml.	Minimum Qty/Pack	Price/Piece (₹)
18/1	10	0.05	0.05	2	1550.00
18/2	25	0.1	0.1	2	1550.00
18/3	50	0.1	0.1	2	1595.00
18/4	100	0.2	0.2	2	1750.00

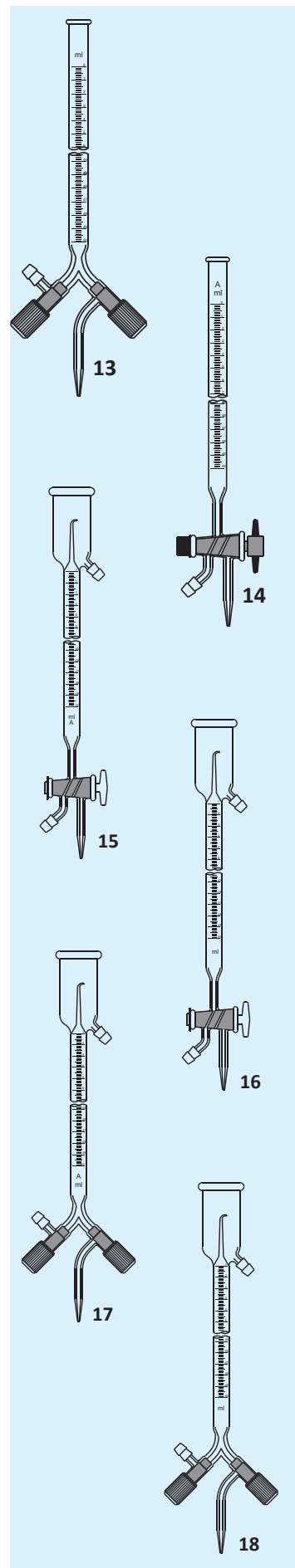

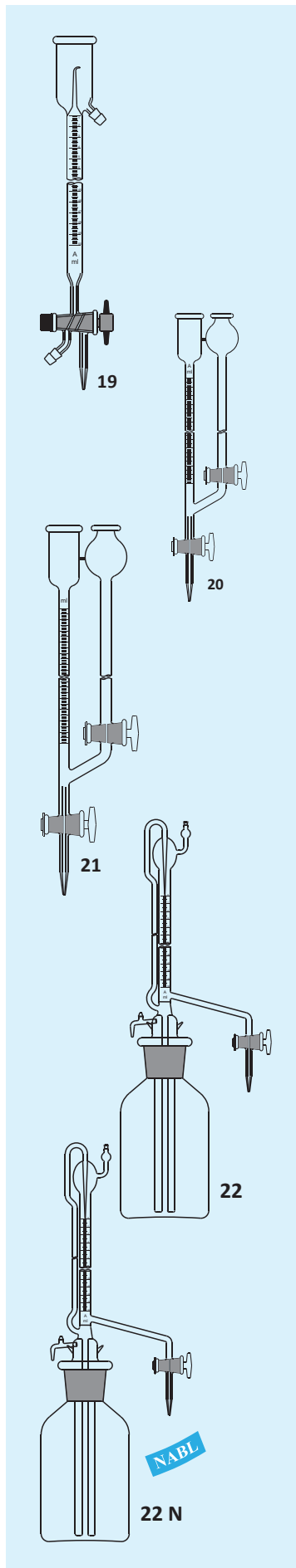

19 Burettes, Over Flow Cup, Automatic Zero, Double Oblique Bore PTFE Key Stopcock, 3-way, "JSGW", Accuracy as per Class 'A', with works certificate.

Cat. No.	Capacity ml.	Sub. Div. ml.	Tolerance $\pm$ ml.	Minimum Qty/Pack	Price/Piece (₹)
19/1	10	0.05	0.02	2	3475.00
19/2	25	0.1	0.05	2	3475.00
19/3	50	0.1	0.05	2	3535.00
19/4	100	0.2	0.1	2	3600.00

20 Burettes, Micro, Automatic Filling Device with Reservoir, "JSGW", Accuracy as per Class 'A', with works certificate.

Cat. No.	Capacity ml.	Sub. Div. ml.	Tolerance $\pm$ ml.	Minimum Qty/Pack	Price/Piece (₹)
20/1	1	0.01	0.006	2	2725.00
20/2	2	0.02	0.01	2	2725.00
20/3	5	0.02	0.01	2	2725.00
20/4	10	0.05	0.02	2	2725.00

21 Burettes, Micro, Automatic Filling Device with Reservoir, "JSGW", Accuracy as per Class 'B'.

Cat. No.	Capacity ml.	Sub. Div. ml.	Tolerance $\pm$ ml.	Minimum Qty/Pack	Price/Piece (₹)
21/1	1	0.01	0.01	2	2030.00
21/2	2	0.02	0.02	2	2030.00
21/3	5	0.02	0.02	2	2030.00
21/4	10	0.05	0.05	2	2030.00

22 Burettes, Automatic Zero, Glass Key Stopcock, "JSGW" mounted on Reservoir, with Rubber bellow, Accuracy as per Class 'A', with works certificate.

Cat. No.	Capacity ml.	Sub. Div. ml.	Tolerance $\pm$ ml.	Minimum Qty/Pack	Price/Piece (₹)
22/1	10	0.05	0.02	1	8485.00
22/2	25	0.1	0.05	1	9790.00
22/2-1	25	0.05	0.03	1	12475.00
22/3	50	0.1	0.05	1	10645.00
22/4	100	0.2	0.1	1	11140.00

Note : Reservoir Capacity for 10ml Burette is 500ml and for 25ml, 50ml & 100ml Burettes is 2000ml.

22 N Burettes, Automatic Zero, Glass Key Stopcock, "JSGW" mounted on Reservoir, with Rubber bellow, Accuracy as per Class 'A', with NABL works certificate.

Cat. No.	Capacity ml.	Sub. Div. ml.	Tolerance $\pm$ ml.	Minimum Qty/Pack	Price/Piece (₹)
22N/1	10	0.05	0.02	1	10830.00
22N/2	25	0.1	0.05	1	13115.00
22N/3	50	0.1	0.05	1	13495.00
22N/4	100	0.2	0.1	1	14255.00

Note : Reservoir Capacity for 10ml Burette is 500ml and for 25ml, 50ml & 100ml Burettes is 2000ml.

- 22A Amber Colour Burettes, "JSGW", Automatic zero, with Glass Key Stopcock mounted on reservoir, with rubber bellow, accuracy as per Class 'A', with work Certificate.

Cat. No.	Capacity ml.	Sub Div. ml.	Tolerance ± ml.	Minimum Qty/Pack	Price/Piece (₹)
22A/1	10	0.05	0.02	1	14505.00
22A/2	25	0.1	0.05	1	15325.00
22A/3	50	0.1	0.05	1	17575.00
22A/4	100	0.2	0.1	1	18185.00

Note : Reservoir Capacity for 10ml Burette is 500ml and for 25ml, 50ml & 100ml Burettes is 2000ml.

- 22AN Amber Colour Burettes, "JSGW", Automatic zero, with Glass Key Stopcock mounted on reservoir, with rubber bellow, accuracy as per Class 'A' with NABL Certificate.

Cat. No.	Capacity ml.	Sub Div. ml.	Tolerance ± ml.	Minimum Qty/Pack	Price/Piece (₹)
22AN/1	10	0.05	0.02	1	18210.00
22AN/2	25	0.1	0.05	1	19145.00
22AN/3	50	0.1	0.05	1	21480.00
22AN/4	100	0.2	0.1	1	22650.00

Note : Reservoir Capacity for 10ml Burette is 500ml and for 25ml, 50ml & 100ml Burettes is 2000ml.

- 23 Burettes, Automatic Zero Glass Key Stopcock, "JSGW", mounted on Reservoir, Rubber bellow, Accuracy as per Class 'B'.

Cat. No.	Capacity ml.	Sub. Div. ml.	Tolerance ± ml.	Minimum Qty/Pack	Price/Piece (₹)
23/1	10	0.05	0.05	1	7335.00
23/2	25	0.1	0.1	1	8610.00
23/3	50	0.1	0.1	1	8795.00
23/4	100	0.2	0.2	1	9420.00

Note : Reservoir Capacity for 10ml Burette is 500ml and for 25ml, 50ml & 100ml Burettes is 2000ml.

- 24 Burettes, Automatic Zero Screw type PTFE Needle Valve Stopcock, "JSGW", mounted on Reservoir, Rubber bellow, Accuracy as per Class 'A', with works certificate.

Cat. No.	Capacity ml.	Sub. Div. ml.	Tolerance ± ml.	Minimum Qty/Pack	Price/Piece (₹)
24/1	10	0.05	0.02	1	9355.00
24/2	25	0.1	0.05	1	9505.00
24/3	50	0.1	0.05	1	10645.00
24/4	100	0.2	0.1	1	11140.00

Note : Reservoir Capacity for 10ml Burette is 500ml and for 25ml, 50ml & 100ml Burettes is 2000ml.

- 24N Burettes, Automatic Zero Screw type PTFE Needle Valve Stopcock, "JSGW", mounted on Reservoir, Rubber bellow, Accuracy as per Class 'A' with NABL, with works certificate.

Cat. No.	Capacity ml.	Sub. Div. ml.	Tolerance ± ml.	Minimum Qty/Pack	Price/Piece (₹)
24N/1	10	0.05	0.02	1	10830.00
24N/2	25	0.1	0.05	1	13115.00
24N/3	50	0.1	0.05	1	13495.00
24N/4	100	0.2	0.1	1	14255.00

Note : Reservoir Capacity for 10ml Burette is 500ml and for 25ml, 50ml & 100ml Burettes is 2000ml.

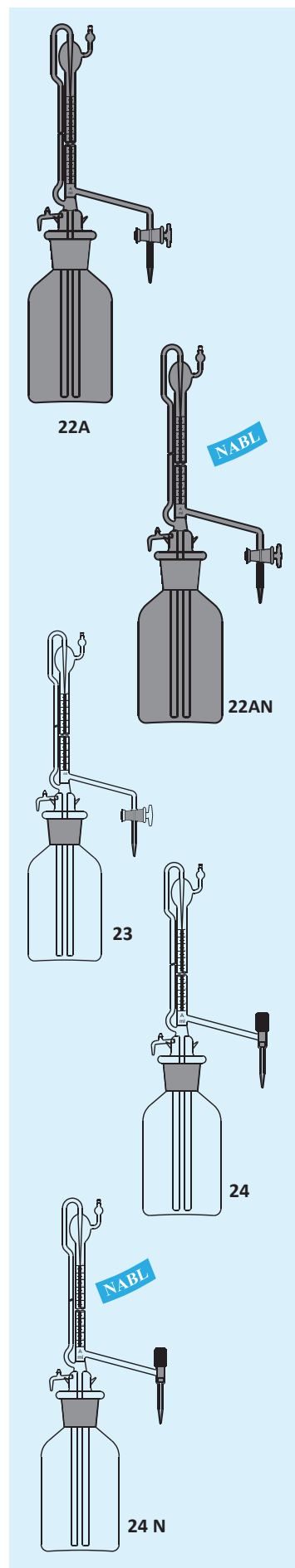

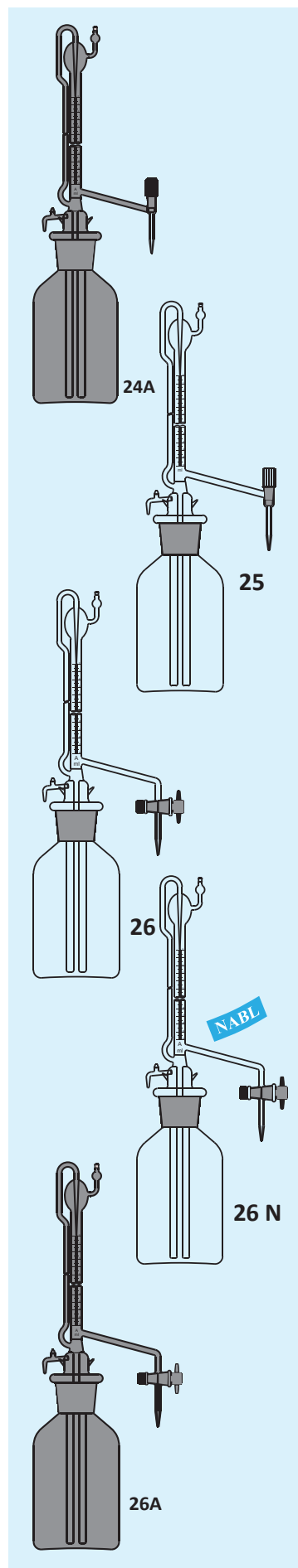

- 24A Amber Colour Burettes, "JSGW", Automatic zero, Screw type PTFE Needle Valve Stopcock mounted on reservoir, with rubber bellow, accuracy as per **Class 'A'**, with work Certificate.

Cat. No.	Capacity ml.	Sub Div. ml.	Tolerance $\pm$ ml.	Minimum Qty/Pack	Price/Piece (₹)
24A/1	10	0.05	0.02	1	14505.00
24A/2	25	0.1	0.05	1	15325.00
24A/3	50	0.1	0.05	1	17575.00
24A/4	100	0.2	0.1	1	18185.00

Note : Reservoir Capacity for 10ml Burette is 500ml and for 25ml, 50ml & 100ml Burettes is 2000ml.

- 25 Burettes, Automatic Zero Screw type PTFE Needle Valve Stopcock, "JSGW", mounted on Reservoir, Rubber bellow, Accuracy as per **Class 'B'**.

Cat. No.	Capacity ml.	Sub. Div. ml.	Tolerance $\pm$ ml.	Minimum Qty/Pack	Price/Piece (₹)
25/1	10	0.05	0.05	1	7335.00
25/2	25	0.1	0.1	1	8590.00
25/3	50	0.1	0.1	1	8795.00
25/4	100	0.2	0.2	1	9420.00

Note : Reservoir Capacity for 10ml Burette is 500ml and for 25ml, 50ml & 100ml Burettes is 2000ml.

- 26 Burettes, Automatic Zero with PTFE Key Stopcock, "JSGW", mounted on Reservoir, Rubber bellow, Accuracy as per **Class 'A'**, with works certificate.

Cat. No.	Capacity ml.	Sub. Div. ml.	Tolerance $\pm$ ml.	Minimum Qty/Pack	Price/Piece (₹)
26/1	10	0.05	0.02	1	10005.00
26/2	25	0.1	0.05	1	10525.00
26/3	50	0.1	0.05	1	11140.00
26/4	100	0.2	0.1	1	11640.00

Note : Reservoir Capacity for 10ml Burette is 500ml and for 25ml, 50ml & 100ml Burettes is 2000ml.

- 26N Burettes, Automatic Zero with PTFE Key Stopcock, "JSGW", mounted on Reservoir, Rubber bellow, Accuracy as per **Class 'A'**, with **NABL** works certificate.

Cat. No.	Capacity ml.	Sub. Div. ml.	Tolerance $\pm$ ml.	Minimum Qty/Pack	Price/Piece (₹)
26N/1	10	0.05	0.02	1	11780.00
26N/2	25	0.1	0.05	1	13680.00
26N/3	50	0.1	0.05	1	14060.00
26N/4	100	0.2	0.1	1	14630.00

Note : Reservoir Capacity for 10ml Burette is 500ml and for 25ml, 50ml & 100ml Burettes is 2000ml.

- 26A Amber Colour Burettes, "JSGW", Automatic zero, with PTFE Key Stopcock mounted on reservoir, Accuracy as per **Class 'A'** with rubber bellow.

Cat. No.	Capacity ml.	Sub Div. ml.	Tolerance ml.	Minimum Qty/Pack	Price/Piece (₹)
26A/1	10	0.05	0.02	1	15125.00
26A/2	25	0.1	0.05	1	16145.00
26A/3	50	0.1	0.05	1	18385.00
26A/4	100	0.2	0.1	1	19000.00

Note : Reservoir capacity 500 ml. for 10 ml. burette and 2000 ml. for 25, 50 and 100 ml. Burettes

26 AN Amber Colour Burettes, Automatic Zero with PTFE Key Stopcock, "JSGW", mounted on Reservoir, Rubber bellow, Accuracy as per Class 'A', with NABL works certificate.

Cat. No.	Capacity ml.	Sub Div. ml.	Tolerance ml.	Minimum Qty/Pack	Price/Piece (₹)
26AN/1	10	0.05	0.02	1	18915.00
26AN/2	25	0.1	0.05	1	19850.00
26AN/3	50	0.1	0.05	1	22185.00
26AN/4	100	0.2	0.1	1	23350.00

Note : Reservoir Capacity for 10ml Burette is 500ml and for 25ml, 50ml & 100ml Burettes is 2000ml.

27 Burettes, Automatic Zero with PTFE Key Stopcock, for Karl Fisher Apparatus, "JSGW", mounted on Reservoir, Rubber bellow, Accuracy as per Class 'A', with works certificate.

Cat. No.	Capacity ml.	Sub. Div. ml.	Tolerance ± ml.	Minimum Qty/Pack	Price/Piece (₹)
27/1	10	0.05	0.02	1	9975.00
27/2	25	0.1	0.05	1	11475.00

Note : Reservoir Capacity 500 ml.

		Minimum Qty/Pack	Price/Piece (₹)
30	Spare rubber bellow with cotton net for automatic burettes.	2	585.00

		Minimum Qty/Pack	Price/Per Pack (₹)
31	Burette cleaning Brush, 30" long, Nylon.	10	1590.00

32 Burette Stand with clamp, made of heavy duty steel alloy with rubber lining for stability.

		Minimum Qty/Pack	Price/Per Pack (₹)
32	Base size 8"x5", Rod length 24"	1	2850.00

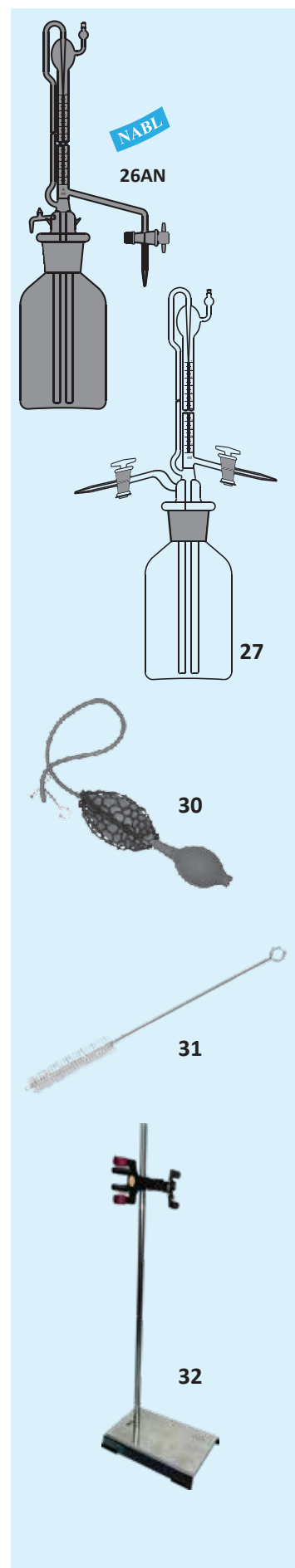

## PIPETTES

**36** Pipettes Transfer Volumetric, "JSGW", with one mark,  marked **Class 'A'** of IS 1117 : 1975, with works certificate.

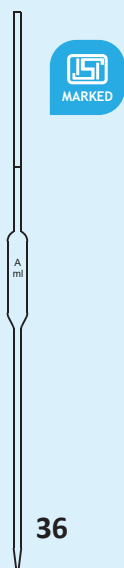

Cat. No.	Capacity ml.	Tolerance ± ml.	Minimum Qty/Pack	Price/Piece (₹)
36/1	1	0.006	10	330.00
36/2	2	0.01	10	330.00
36/2-3	*3	0.01	10	330.00
36/2-4	*4	0.01	10	330.00
36/3	5	0.015	10	340.00
36/3-6	*6	0.015	10	340.00
36/3-7	*7	0.015	10	340.00
36/3-8	*8	0.02	10	340.00
36/3-9	*9	0.02	10	340.00
36/4	10	0.02	10	340.00
36/4-15	*15	0.02	10	410.00
36/5	20	0.03	10	410.00
36/6	25	0.03	10	415.00
36/7	50	0.05	10	535.00
36/8	100	0.08	10	740.00

**36 N** Pipettes Transfer Volumetric, "JSGW", with one mark, Accuracy as per **Class 'A'**, with **NABL** works certificate. Supplied with Colour Code.

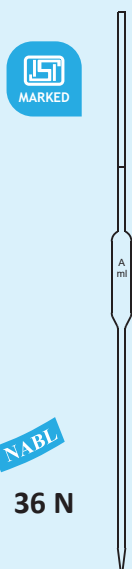

Cat. No.	Capacity ml.	Tolerance ± ml.	Minimum Qty/Pack	Price/Piece (₹)
36N/1	1	0.006	10	775.00
36N/2	2	0.01	10	775.00
36N/2-3	*3	0.01	10	775.00
36N/2-4	*4	0.01	10	775.00
36N/3	5	0.015	10	775.00
36N/3-6	*6	0.015	10	775.00
36N/3-7	*7	0.015	10	775.00
36N/3-8	*8	0.02	10	775.00
36N/3-9	*9	0.02	10	775.00
36N/4	10	0.02	10	775.00
36N/4-15	*15	0.02	10	790.00
36N/5	20	0.03	10	810.00
36N/6	25	0.03	10	810.00
36N/7	50	0.05	10	860.00
36N/8	100	0.08	10	955.00

Note : \* Not covered under IS. Pipettes with Safety Bulb 10% extra.

**36Q** Pipettes Transfer Volumetric, "JSGW", with one mark, QR Code Accuracy as per Class 'A' with works certificate. Supplied with Colour Code.

Cat. No.	Capacity ml.	Tolerance $\pm$ ml.	Minimum Qty/Pack	Price/Piece (₹)
36Q/3	5	0.015	10	380.00
36Q/3-6	*6	0.015	10	380.00
36Q/3-7	*7	0.015	10	380.00
36Q/3-8	*8	0.02	10	380.00
36Q/3-9	*9	0.02	10	380.00
36Q/4	10	0.02	10	380.00
36Q/4-15	*15	0.02	10	465.00
36Q/5	20	0.03	10	465.00
36Q/6	25	0.03	10	465.00
36Q/7	50	0.05	10	585.00
36Q/8	100	0.08	10	790.00

**36A** Amber Colour Pipettes Transfer Volumetric, "JSGW", with one mark, Accuracy as per Class 'A', with works certificate.

Cat. No.	Capacity ml.	Tolerance $\pm$ ml.	Minimum Qty/Pack	Price/Piece (₹)
36A/1	1	0.006	5	520.00
36A/2	2	0.01	5	520.00
36A/3	5	0.015	5	520.00
36A/4	10	0.02	5	570.00
36A/5	20	0.03	5	640.00
36A/6	25	0.03	5	640.00
36A/7	50	0.05	5	835.00
36A/8	100	0.08	5	1050.00

**36 AN** Amber Colour Pipettes Transfer Volumetric, "JSGW", with one mark, Accuracy as per Class 'A' with NABL works certificate.

Cat. No.	Capacity ml.	Tolerance $\pm$ ml.	Minimum Qty/Pack	Price/Piece (₹)
36AN/1	1	0.006	2	1165.00
36AN/2	2	0.01	2	1165.00
36AN/3	5	0.015	2	1165.00
36AN/4	10	0.02	2	1190.00
36AN/5	20	0.03	2	1245.00
36AN/6	25	0.03	2	1245.00
36AN/7	50	0.05	2	1385.00
36AN/8	100	0.08	2	1495.00

**37** Pipettes Transfer, Volumetric, "JSGW", with one mark. Accuracy as per Class 'B'

Cat. No.	Capacity ml.	Tolerance $\pm$ ml.	Minimum Qty/Pack	Price/Piece (₹)
37/1	1	0.015	10	205.00
37/2	2	0.02	10	205.00
37/3	5	0.03	10	205.00
37/4	10	0.04	10	210.00
37/5	20	0.06	10	225.00
37/6	25	0.06	10	225.00
37/7	50	0.1	10	350.00
37/8	100	1.16	10	435.00

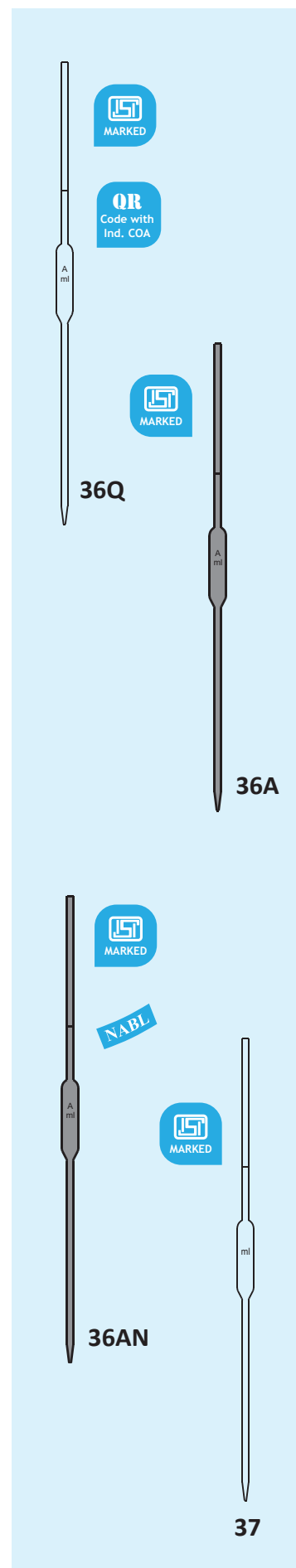

**38 Pipettes, Transfer, Volumetric, "JSGW" accuracy as per Class 'A' of ASTM (USP) Standards E969 - 02, with Certificate. With Colour Code.**

Cat. No.	Capacity ml.	Tolerance $\pm$ ml.	Minimum Qty/Pack	Price/Piece (₹)
38/1	1	0.006	10	340.00
38/2	2	0.006	10	345.00
38/3	3	0.01	10	345.00
38/4	4	0.01	10	345.00
38/5	5	0.01	10	355.00
38/6	6	0.01	10	365.00
38/7	7	0.01	10	365.00
38/8	8	0.02	10	365.00
38/9	9	0.02	10	365.00
38/10	10	0.02	10	375.00
38/11	15	0.03	10	425.00
38/12	20	0.03	10	435.00
38/13	25	0.03	10	450.00
38/14	30	0.03	10	455.00
38/15	40	0.05	10	570.00
38/16	50	0.05	10	610.00
38/17	100	0.08	10	780.00

**38Q Pipettes, Transfer, Volumetric, "JSGW" with QR Code accuracy as per Class 'A' of ASTM Standards E969 - 02, with Certificate. With Colour Code.**

Cat. No.	Capacity ml.	Tolerance $\pm$ ml.	Minimum Qty/Pack	Price/Piece (₹)
38Q/5	5	0.01	10	395.00
38Q/6	6	0.01	10	415.00
38Q/7	7	0.01	10	415.00
38Q/8	8	0.02	10	415.00
38Q/9	9	0.02	10	415.00
38Q/10	10	0.02	10	425.00
38Q/11	15	0.03	10	475.00
38Q/12	20	0.03	10	485.00
38Q/13	25	0.03	10	490.00
38Q/14	30	0.03	10	505.00
38Q/15	40	0.05	10	620.00
38Q/16	50	0.05	10	660.00
38Q/17	100	0.08	10	830.00

**39 Pipettes, Measuring, Graduated, Serological, "JSGW" Accuracy as per Class 'A' with works certificate. Colour coded. (These pipettes are calibrated to deliver from any graduation line down to zero at the jet, with the last drop expelled by blowing).**

Cat. No.	Capacity ml.	Sub. Div. ml.	Tolerance $\pm$ ml.	Minimum Qty/Pack	Price/Piece (₹)
39/1	0.1	0.01	0.006	10	385.00
39/2	0.2	0.01	0.006	10	385.00
39/3	0.5	0.01	0.006	10	385.00
39/4	1	0.01	0.007	10	385.00
39/5	1	0.1	0.007	10	385.00
39/6	2	0.02	0.01	10	385.00
39/7	2	0.1	0.01	10	385.00
39/8	5	0.05	0.03	10	385.00
39/9	5	0.1	0.03	10	385.00
39/10	10	0.1	0.05	10	385.00
39/11	25	0.2	0.1	10	535.00

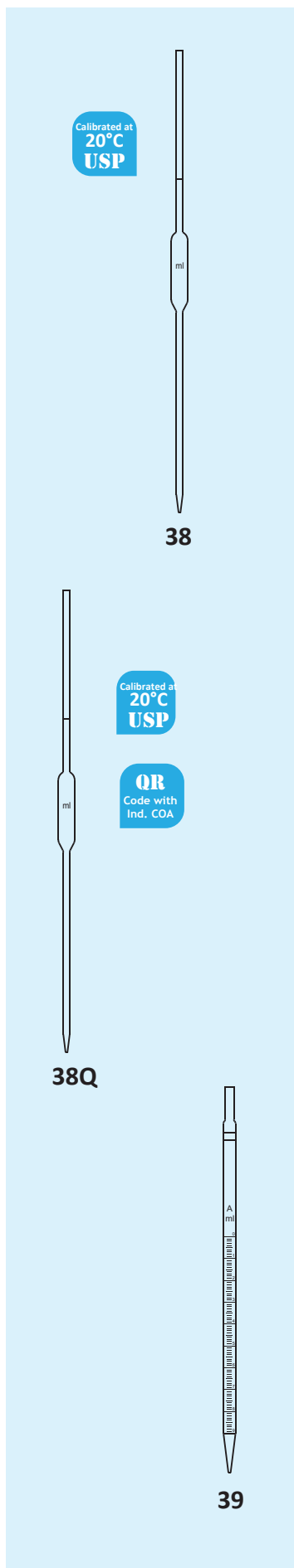

- 39 N Pipettes, Measuring, Graduated, Serological, "JSGW" Accuracy as per Class 'A' with NABL works certificate. Colour coded.

Cat. No.	Capacity ml.	Sub. Div. ml.	Tolerance $\pm$ ml.	Minimum Qty/Pack	Price/Piece (₹)
39N/1	0.1	0.01	0.006	10	855.00
39N/2	0.2	0.01	0.006	10	855.00
39N/3	0.5	0.01	0.006	10	855.00
39N/4	1	0.01	0.007	10	855.00
39N/5	1	0.1	0.007	10	855.00
39N/6	2	0.02	0.01	10	855.00
39N/7	2	0.1	0.01	10	855.00
39N/8	5	0.05	0.03	10	855.00
39N/9	5	0.1	0.03	10	855.00
39N/10	10	0.1	0.05	10	855.00
39N/11	25	0.2	0.1	10	905.00

- 39A Amber Colour Pipettes, Graduated, Serological "JSGW", Accuracy as per 'Class A'.

Cat. No.	Capacity ml.	Sub Div. ml.	Tolerance ml.	Minimum Qty/Pack	Price/Piece (₹)
39A/1	0.1	0.01	0.006	5	655.00
39A/2	0.2	0.01	0.006	5	655.00
39A/3	0.5	0.01	0.006	5	655.00
39A/4	1.0	0.01	0.006	5	655.00
39A/5	1.0	0.1	0.006	5	655.00
39A/6	2.0	0.02	0.01	5	655.00
39A/7	2.0	0.1	0.01	5	655.00
39A/8	5.0	0.05	0.03	5	655.00
39A/9	5.0	0.1	0.03	5	655.00
39A/10	10.0	0.1	0.05	5	655.00
39A/11	25.0	0.2	0.1	5	765.00

- 39 AN Amber Colour Pipettes, Graduated, Serological "JSGW", Accuracy as per 'Class A' with NABL work Certificate.

Cat. No.	Capacity ml.	Sub Div. ml.	Tolerance ml.	Minimum Qty/Pack	Price/Piece (₹)
39AN/1	0.1	0.01	0.006	2	1220.00
39AN/2	0.2	0.01	0.006	2	1220.00
39AN/3	0.5	0.01	0.006	2	1220.00
39AN/4	1.0	0.01	0.006	2	1220.00
39AN/5	1.0	0.1	0.006	2	1220.00
39AN/6	2.0	0.02	0.01	2	1220.00
39AN/7	2.0	0.1	0.01	2	1220.00
39AN/8	5.0	0.05	0.03	2	1220.00
39AN/9	5.0	0.1	0.03	2	1220.00
39AN/10	10.0	0.1	0.05	2	1225.00
39AN/11	25.0	0.2	0.1	2	1260.00

- 39 U Pipettes, Measuring, Graduated, Serological, "JSGW" Accuracy as per Class 'A' with works certificate. Colour coded. As per ASTM 1293 - 02.

(These pipettes are calibrated to deliver from any graduation line down to zero at the jet, with the last drop expelled by blowing).

Cat. No.	Capacity ml.	Sub. Div. ml.	Tolerance $\pm$ ml.	Minimum Qty/Pack	Price/Piece (₹)
39U/4	1	0.01	0.01	10	495.00
39U/5	1	0.1	0.01	10	495.00
39U/7	2	0.1	0.01	10	520.00
39U/9	5	0.1	0.02	10	545.00
39U/10	10	0.1	0.03	10	590.00
39U/11	25	0.2	0.05	10	630.00

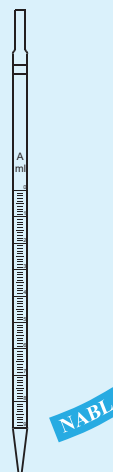

39 N



39A



39AN

Calibrated at  
20°C  
USP



39U



40

- 40 Pipettes, Measuring, Graduated, Serological, "JSGW". Accuracy as per Class 'B' Colour coded. These Pipettes are graduated to tip and deliver their total capacity when last drop is blown out.

Cat. No.	Capacity ml.	Sub. Div. ml.	Tolerance $\pm$ ml.	Minimum Qty/Pack	Price/Piece (₹)
40/1	0.1	0.01	0.01	10	225.00
40/2	0.2	0.01	0.01	10	225.00
40/3	0.5	0.01	0.01	10	225.00
40/4	1	0.01	0.01	10	225.00
40/5	1	0.1	0.01	10	225.00
40/6	2	0.02	0.02	10	225.00
40/7	2	0.1	0.02	10	225.00
40/8	5	0.05	0.05	10	225.00
40/9	5	0.1	0.05	10	225.00
40/10	10	0.1	0.1	10	230.00
40/11	25	0.2	0.2	10	265.00



41

- 41 Pipettes, Measuring, Graduated, Mohr type, "JSGW". Accuracy as per Class 'A' with works certificate. Colour coded. (These Pipettes are graduated for the delivery from zero mark at top to the last graduation mark.)

Cat. No.	Capacity ml.	Sub. Div. ml.	Tolerance $\pm$ ml.	Minimum Qty/Pack	Price/Piece (₹)
41/1*	0.1	0.01	0.006	10	385.00
41/2*	0.2	0.01	0.006	10	385.00
41/3*	0.5	0.01	0.006	10	385.00
41/4	1	0.01	0.007	10	385.00
41/5	1	0.1	0.007	10	385.00
41/6	2	0.02	0.01	10	385.00
41/7*	2	0.1	0.01	10	385.00
41/8	5	0.05	0.03	10	385.00
41/9	5	0.1	0.03	10	385.00
41/10	10	0.1	0.05	10	385.00
41/11	25	0.2	0.1	10	535.00

- 41 N Pipettes, Measuring, Graduated, Mohr type, "JSGW". Accuracy as per Class 'A' with NABL works certificate. Colour coded. (These Pipettes are graduated for the delivery from zero mark at top to the last graduation mark.)

Cat. No.	Capacity ml.	Sub. Div. ml.	Tolerance $\pm$ ml.	Minimum Qty/Pack	Price/Piece (₹)
41N/1*	0.1	0.01	0.006	10	855.00
41N/2*	0.2	0.01	0.006	10	855.00
41N/3*	0.5	0.01	0.006	10	855.00
41N/4	1	0.01	0.007	10	855.00
41N/5	1	0.1	0.007	10	855.00
41N/6	2	0.02	0.01	10	855.00
41N/7*	2	0.1	0.01	10	855.00
41N/8	5	0.05	0.03	10	855.00
41N/9	5	0.1	0.03	10	855.00
41N/10	10	0.1	0.05	10	855.00
41N/11	25	0.2	0.1	10	905.00



41 N

NABL

**41 AN Amber Colour Pipettes, Measuring, Graduated, Mohr type, "JSGW".** Accuracy as per **Class 'A'** with **NABL** works certificate. Colour coded.

(These Pipettes are graduated for the delivery from zero mark at top to the last graduation mark).

Cat. No.	Capacity ml.	Sub. Div. ml.	Tolerance $\pm$ ml.	Minimum Qty/Pack	Price/Piece (₹)
41AN/1*	0.1	0.01	0.006	10	1220.00
41AN/2*	0.2	0.01	0.006	10	1220.00
41AN/3*	0.5	0.01	0.006	10	1220.00
41AN/4	1	0.01	0.007	10	1220.00
41AN/5	1	0.1	0.007	10	1220.00
41AN/6	2	0.02	0.01	10	1220.00
41AN/7*	2	0.1	0.01	10	1220.00
41AN/8	5	0.05	0.03	10	1220.00
41AN/9	5	0.1	0.03	10	1220.00
41AN/10	10	0.1	0.05	10	1225.00
41AN/11	25	0.2	0.1	10	1260.00

**42 Pipettes, Measuring, Graduated, Mohr type, "JSGW".** Accuracy as per **Class 'B'** Colour coded. (These Pipettes are graduated for delivery from zero mark at top to the last graduation mark.)

Cat. No.	Capacity ml.	Sub. Div. ml.	Tolerance $\pm$ ml.	Minimum Qty/Pack	Price/Piece (₹)
42/1*	0.1	0.01	0.01	10	225.00
42/2*	0.2	0.01	0.01	10	225.00
42/3*	0.5	0.01	0.01	10	225.00
42/4	1	0.01	0.01	10	225.00
42/5*	1	0.1	0.01	10	225.00
42/6	2	0.02	0.02	10	225.00
42/7*	2	0.1	0.02	10	225.00
42/8	5	0.05	0.05	10	225.00
42/9	5	0.1	0.05	10	225.00
42/10	10	0.1	0.1	10	230.00
42/11	25	0.2	0.2	10	265.00

**45 Automatic Pipettes "JSGW" with Overflow Cup, Class 'A' with works certificate.**

Cat. No.	Capacity ml.	Tolerance $\pm$ ml.	Price/Piece (₹)
45/1	5	0.06	855.00
45/2	10	0.08	855.00
45/3	20	0.1	910.00
45/4	25	0.12	910.00
45/5	50	0.15	980.00
45/6	100	0.25	1080.00

**46 Automatic Pipettes "JSGW" with Overflow Cup.**

Cat. No.	Capacity ml.	Price/Piece (₹)
46/1	5	630.00
46/2	10	630.00
46/3	20	650.00
46/4	25	650.00
46/5	50	720.00
46/6	100	795.00

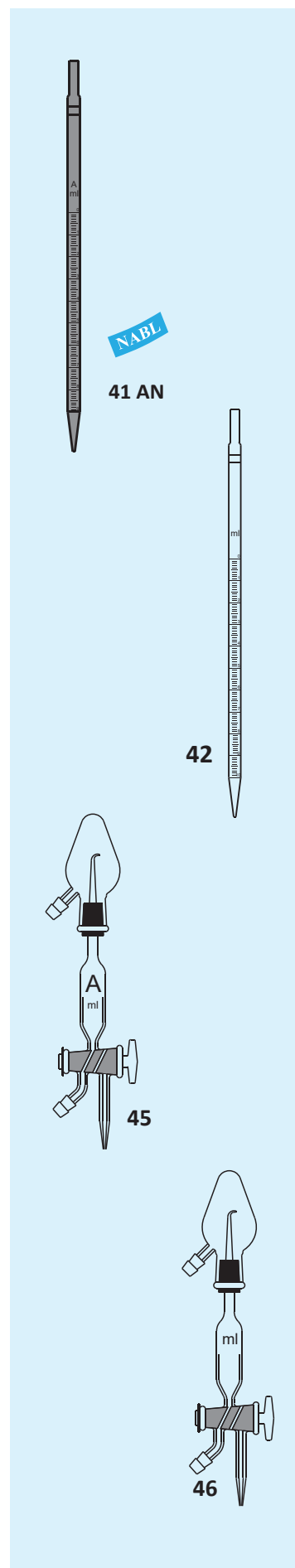

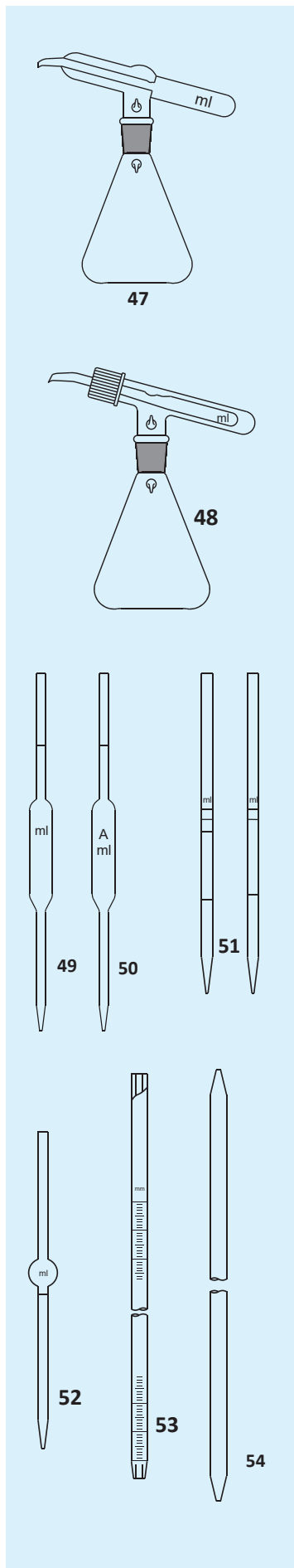

47 Pipettes Automatic "JSGW" Quick acting for rapid work of approximate accuracy (Tilt Measure) complete with Conical Flask, interchangeable joint fitting.

Cat. No.	Capacity ml.	Reservoir Cap. ml.	Minimum Qty/Pack	Price/Piece (₹)
47/1	1	100	2	955.00
47/2	2	100	2	955.00
47/3	5	250	2	1020.00
47/4	10	250	2	1020.00
47/5	20	500	2	1070.00
47/6	25	500	2	1070.00

48 Pipettes Automatic "JSGW" Quick acting for rapid work of approximate accuracy (Tilt Measure) complete with Conical Flask and Screw Cap fitted replaceable head.

Cat. No.	Capacity ml.	Reservoir Cap. ml.	Minimum Qty/Pack	Price/Piece (₹)
48/1	5	250	2	1150.00
48/2	10	250	2	1150.00
48/3	20	500	2	1265.00
48/4	25	500	2	1265.00

	Minimum Qty/Pack	Price/Piece (₹)
49 Pipettes for Milk Testing "JSGW" 10.75 ml.	10	195.00
50 -do- Class 'A' with works certificate, "JSGW"	10	270.00
50N -do- Class 'A' with NABL works certificate, "JSGW"	1	795.00

51 Pipette for Milk Test "JSGW", Bacteriological, Graduated.

Cat. No.	Capacity ml.	Sub. Div. ml.	Tolerance ± ml.	Minimum Qty/Pack	Price/Piece (₹)
51/1	1.1	0.5, 1 & 1.1	0.025	10	255.00
51/2	2.2	1.0, 2.0, 2.1 & 2.2	0.04	10	270.00
52	Pipette Alcohol, "JSGW" 1 ml., one mark.			10	95.00
53	Pipette E.S.R. "JSGW" 200 mm. graduation, 300 mm long			10	120.00
54	Drum Sampling Tube Length 1000 mm, dia 19mm Heavy wall			1	975.00

56 Mechanical Pipette, "JSGW" with 2 stopcocks

Cat. No.	Capacity ml.	Minimum Qty/Pack	Price/Piece (₹)
56/1	10	2	990.00
56/2	20	2	1015.00
56/3	25	2	1020.00

57 Pipette, Artificial Insemination, Cattle, Taper Tip. Borosilicate Glass, 450 mm. long.

10 120.00

58 Pipette, Pasteur, Disposable, Borosilicate Glass.

58/1	Length 145 mm.	100	24.00
58/2	Length 230 mm.	100	27.00

59 Silicon Pipette Filler (Bulb)

Cat. No.	Size	Capacity (ml)	Minimum Qty/Pack	Price/Piece (₹)
59/1	Small	5	10	85.00
59/2	Medium	10	10	110.00
59/3	Large	15	10	140.00
59/4	X. Large	20	10	160.00
59/5	Oval Shape	25	10	260.00
59/6	XX. Large	50	5	500.00
59/7	XXX. Large	100	5	680.00

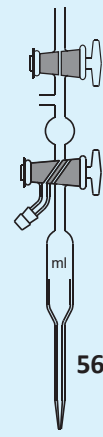

56



57



58

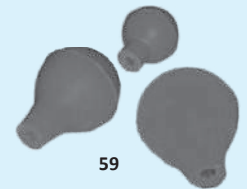

59

## MEASURING / VOLUMETRIC - FLASKS

- 62 Flask Volumetric (Measuring) "JSGW" with interchangeable stopper,  marked Class 'A' of IS 915 : 2012, ISO 1042 : 1998, with works certificate.

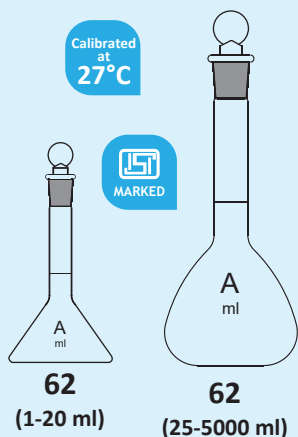

Cat. No.	Capacity ml.	Tolerance ± ml.	Stopper Size	Minimum Qty/Pack	Price/Piece (₹)
62/1	1	0.025	7/16	10	660.00
62/2	2	0.025	7/16	10	660.00
62/3	5	0.025	7/16	10	650.00
62/4	10	0.025	7/16	10	650.00
62/5-1	20	0.04	10/19	10	565.00
62/5	25	0.04	10/19	10	580.00
62/6	50	0.06	12/21	10	570.00
62/7	100	0.10	14/23	10	585.00
62/8	200	0.15	14/23	6	810.00
62/9	250	0.15	14/23	6	815.00
62/10	500	0.25	19/26	5	1305.00
62/11	1000	0.40	24/29	4	1895.00
62/12	2000	0.60	29/32	2	3280.00
62/13	5000	1.20	34/35	1	15525.00
62/14	15 <sup>#</sup>	0.025	10/19*	10	660.00
62/15	30 <sup>#</sup>	0.04	10/19*	10	585.00
62/16	75 <sup>#</sup>	0.06	14/23*	10	600.00
62/17	150 <sup>#</sup>	0.10	14/23*	10	815.00
62/18	300 <sup>#</sup>	0.15	14/23*	6	1050.00
62/19	1500 <sup>#</sup>	0.60	29/32*	2	3075.00

Note : # Not covered in standard.

\* Stopper size not covered in standard.

For spare stopper refer Cat. No. 211A.

**62 N** Flask Volumetric "JSGW" with interchangeable Glass Penny Head Solid Stopper accuracy as per Class 'A', with NABL serialized individual works certificate.

Cat. No.	Capacity ml.	Tolerance $\pm$ ml.	Stopper Size	Minimum Qty/Pack	Price/Piece (₹)
62N/1	1	0.025	7/16	2	1015.00
62N/2	2	0.025	7/16	2	1015.00
62N/3	5	0.025	7/16	2	1020.00
62N/4	10	0.025	7/16	2	1050.00
62N/5-1	20	0.04	10/19	2	990.00
62N/5	25	0.04	10/19	2	955.00
62N/6	50	0.06	12/21	2	920.00
62N/7	100	0.10	14/23	2	890.00
62N/8	200	0.15	14/23	2	1255.00
62N/9	250	0.15	14/23	2	1265.00
62N/10	500	0.25	19/26	2	1615.00
62N/11	1000	0.40	24/29	2	2370.00
62N/12	2000	0.60	29/32	2	3855.00

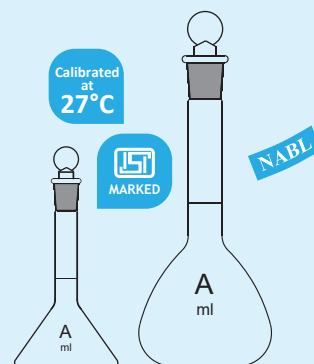

**62 N** (1-20 ml) **62 N** (25-2000 ml)

**62 P** NEW Flask Volumetric "JSGW" with interchangeable PTFE Knob Stopper, Accuracy as per Class 'A', with serialized individual works certificate.

Cat. No.	Capacity ml.	Tolerance $\pm$ ml.	Stopper Size	Minimum Qty/Pack	Price/Piece (₹)
62P/1	1	0.025	7/16	10	780.00
62P/2	2	0.025	7/16	10	780.00
62P/3	5	0.025	7/16	10	765.00
62P/4	10	0.025	7/16	10	765.00
62P/5-1	20	0.04	10/19	10	680.00
62P/5	25	0.04	10/19	10	690.00
62P/6	50	0.06	12/21	10	730.00
62P/7	100	0.10	14/23	10	785.00
62P/8	200	0.15	14/23	6	1015.00
62P/9	250	0.15	14/23	6	1020.00
62P/10	500	0.25	19/26	5	1635.00
62P/11	1000	0.40	24/29	4	2370.00
62P/12	2000	0.60	29/32	2	3905.00

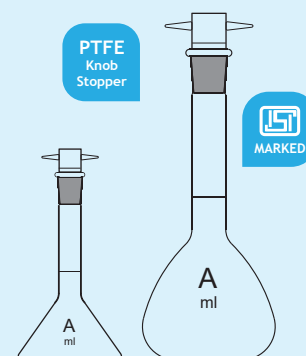

**62 P** (5-20 ml) **62 P** (25-2000 ml)

**62 Q** Flask Volumetric "JSGW" with I/C Glass Penny Head Solid Stopper, with QR Code, Accuracy as per Class 'A', with serialized individual works certificate.

Cat. No.	Capacity ml.	Tolerance $\pm$ ml.	Stopper Size	Minimum Qty/Pack	Price/Piece (₹)
62Q/3	5	0.025	7/16	10	725.00
62Q/4	10	0.025	7/16	10	720.00
62Q/5-1	20	0.04	10/19	10	645.00
62Q/5	25	0.04	10/19	10	650.00
62Q/6	50	0.06	12/21	10	645.00
62Q/7	100	0.10	14/23	10	655.00
62Q/8	200	0.15	14/23	6	880.00
62Q/9	250	0.15	14/23	6	885.00
62Q/10	500	0.25	19/26	5	1375.00
62Q/11	1000	0.40	24/29	4	1975.00
62Q/12	2000	0.60	29/32	2	3455.00

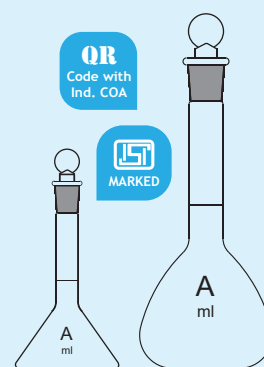

**62 Q** (5-20 ml) **62 Q** (25-2000 ml)

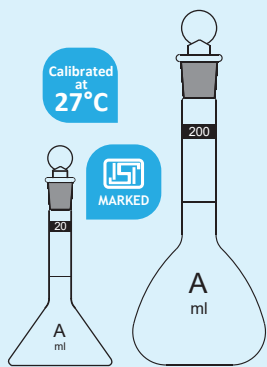

**62 C** (5-20 ml) **62 C** (25-2000 ml)

**62 C** Flask Volumetric "JSGW" with Glass Penny Head Solid Stopper, Colour Coded, Accuracy as per Class 'A', with serialized individual works certificate.

Cat. No.	Capacity ml.	Tolerance ± ml.	Stopper Size	Colour Code	Minimum Qty/Pack	Price/Piece (₹)
62C/3	5	0.025	7/16	Yellow	10	725.00
62C/4	10	0.025	7/16	Red	10	720.00
62C/5-1	20	0.04	10/19	Orange	10	645.00
62C/5	25	0.04	10/19	Blue	10	650.00
62C/6	50	0.06	12/21	Black	10	645.00
62C/7	100	0.10	14/23	Green	10	655.00
62C/8	200	0.15	14/23	Brown	6	880.00
62C/9	250	0.15	14/23	White	6	885.00
62C/10	500	0.25	19/26	Yellow	5	1375.00
62C/11	1000	0.40	24/29	Red	4	1975.00
62C/12	2000	0.60	29/32	Brown	2	3455.00

**62 QC** Flask Volumetric "JSGW" with interchangeable Glass Penny Head Solid Stopper, with QR Code and Colour Coded, Accuracy as per Class 'A', with serialized individual works certificate.

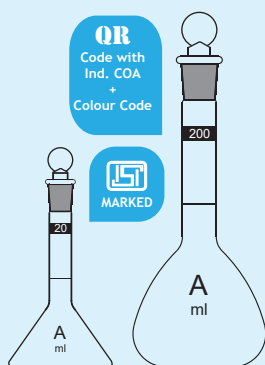

**62 QC** (5-20 ml) **62 QC** (25-2000 ml)

Cat. No.	Capacity ml.	Tolerance ± ml.	Stopper Size	Colour Code	Minimum Qty/Pack	Price/Piece (₹)
62QC/3	5	0.025	7/16	Yellow	10	760.00
62QC/4	10	0.025	7/16	Red	10	760.00
62QC/5-1	20	0.04	10/19	Orange	10	680.00
62QC/5	25	0.04	10/19	Blue	10	685.00
62QC/6	50	0.06	12/21	Black	10	680.00
62QC/7	100	0.10	14/23	Green	10	690.00
62QC/8	200	0.15	14/23	Brown	6	915.00
62QC/9	250	0.15	14/23	White	6	925.00
62QC/10	500	0.25	19/26	Yellow	5	1410.00
62QC/11	1000	0.40	24/29	Red	4	2005.00
62QC/12	2000	0.60	29/32	Brown	2	3485.00

**62 AP** Amber Colour Flask Volumetric "JSGW" with interchangeable PTFE Knob Stopper, Accuracy as per Class 'A', with serialized individual works certificate.

**NEW**

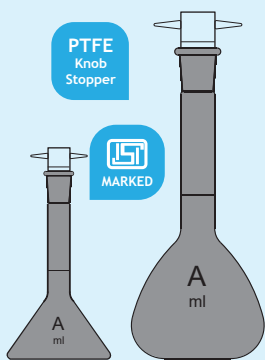

**62 AP** (5-20 ml) **62 AP** (25-2000 ml)

Cat. No.	Capacity ml.	Tolerance ± ml.	Stopper Size	Minimum Qty/Pack	Price/Piece (₹)
62AP/1	1	0.025	7/16	10	920.00
62AP/2	2	0.025	7/16	10	920.00
62AP/3	5	0.025	7/16	10	920.00
62AP/4	10	0.025	7/16	10	930.00
62AP/5-1	20	0.04	10/19	10	880.00
62AP/5	25	0.04	10/19	10	885.00
62AP/6	50	0.06	12/21	10	915.00
62AP/7	100	0.10	14/23	10	785.00
62AP/8	200	0.15	14/23	6	1015.00
62AP/9	250	0.15	14/23	6	1020.00
62AP/10	500	0.25	19/26	5	1635.00
62AP/11	1000	0.40	24/29	4	2370.00
62AP/12	2000	0.60	29/32	2	4920.00

**62 A** Amber Colour, Flask Volumetric "JSGW" with interchangeable Glass Penny Head Solid Stopper, Accuracy as per Class 'A', with serialized individual works certificate.

Cat. No.	Capacity ml.	Tolerance $\pm$ ml.	Stopper Size	Minimum Qty/Pack	Price/Piece (₹)
62A/1	1	0.025	7/16	10	765.00
62A/2	2	0.025	7/16	10	765.00
62A/3	5	0.025	7/16	10	810.00
62A/4	10	0.025	7/16	10	820.00
62A/5-1	20	0.04	10/19	10	775.00
62A/5	25	0.04	10/19	10	780.00
62A/6	50	0.06	12/21	10	760.00
62A/7	100	0.10	14/23	10	790.00
62A/8	200	0.15	14/23	6	1075.00
62A/9	250	0.15	14/23	6	1055.00
62A/10	500	0.25	19/26	5	1595.00
62A/11	1000	0.40	24/29	4	2380.00
62A/12	2000	0.60	29/32	2	4315.00
62A/13	5000	1.20	34/35	1	25395.00
62A/14	15 <sup>#</sup>	0.025	10/19*	10	825.00
62A/15	30 <sup>#</sup>	0.04	10/19*	10	875.00
62A/16	75 <sup>#</sup>	0.06	14/23*	10	830.00
62A/17	150 <sup>#</sup>	0.10	14/23*	10	890.00
62A/18	300 <sup>#</sup>	0.15	14/23*	6	1045.00
62A/19	1500 <sup>#</sup>	0.60	29/32*	2	4920.00

Note : # Not covered in standard.

\* Stopper size not covered in standard.

For spare stopper refer Cat. No. 211A.

**62 AN** Amber Colour, Flask Volumetric "JSGW" with interchangeable Glass Penny Head Solid Stopper, accuracy as per Class 'A', with NABL serialized individual works certificate.

Cat. No.	Capacity ml.	Tolerance $\pm$ ml.	Stopper Size	Minimum Qty/Pack	Price/Piece (₹)
62AN/1	1	0.025	7/16	2	1055.00
62AN/2	2	0.025	7/16	2	1055.00
62AN/3	5	0.025	7/16	2	1055.00
62AN/4	10	0.025	7/16	2	1055.00
62AN/5-1	20	0.04	10/19	2	1125.00
62AN/5	25	0.04	10/19	2	1125.00
62AN/6	50	0.06	12/21	2	1220.00
62AN/7	100	0.10	14/23	2	1305.00
62AN/8	200	0.15	14/23	2	1550.00
62AN/9	250	0.15	14/23	2	1550.00
62AN/10	500	0.25	19/26	2	2260.00
62AN/11	1000	0.40	24/29	2	3120.00
62AN/12	2000	0.60	29/32	2	5480.00

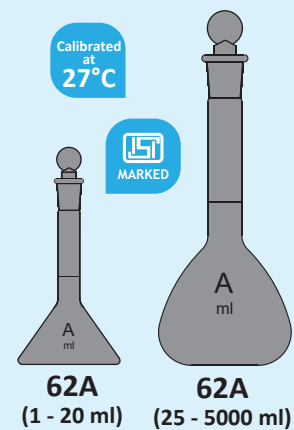

**62A** (1 - 20 ml)      **62A** (25 - 5000 ml)

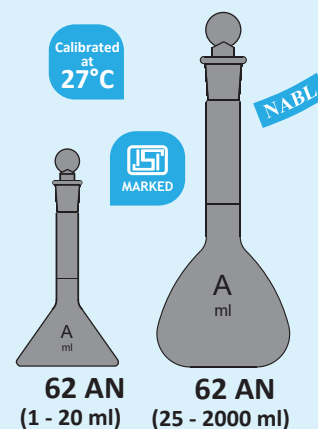

**62 AN** (1 - 20 ml)      **62 AN** (25 - 2000 ml)

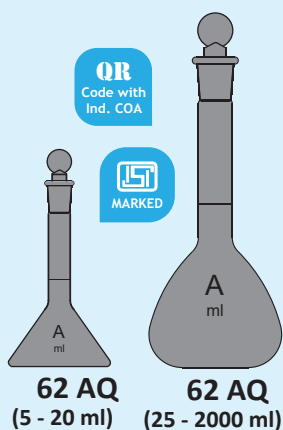

**62 AQ** Amber Colour, Flask Volumetric "JSGW" with interchangeable Glass Penny Head Solid Stopper, with QR Code, accuracy as per Class 'A', with serialized individual works certificate.

Cat. No.	Capacity ml.	Tolerance ± ml.	Stopper Size	Minimum Qty/Pack	Price/Piece (₹)
62AQ/3	5	0.025	7/16	10	880.00
62AQ/4	10	0.025	7/16	10	890.00
62AQ/5-1	20	0.04	10/19	10	845.00
62AQ/5	25	0.04	10/19	10	850.00
62AQ/6	50	0.06	12/21	10	825.00
62AQ/7	100	0.10	14/23	10	880.00
62AQ/8	200	0.15	14/23	6	1125.00
62AQ/9	250	0.15	14/23	6	1135.00
62AQ/10	500	0.25	19/26	5	1665.00
62AQ/11	1000	0.40	24/29	4	2450.00
62AQ/12	2000	0.60	29/32	2	4515.00

**62 AC** Amber Colour, Flask Volumetric "JSGW" with interchangeable Glass Penny Head Solid Stopper, Colour Coded accuracy as per Class 'A', with serialized individual works certificate.

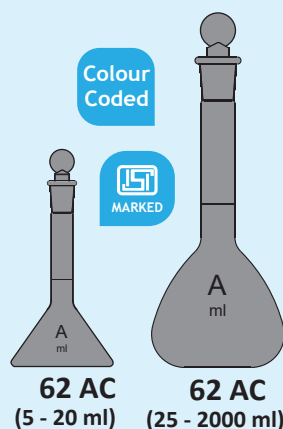

Cat. No.	Capacity ml.	Tolerance ± ml.	Stopper Size	Colour Code	Minimum Qty/Pack	Price/Piece (₹)
62AC/3	5	0.025	7/16	Yellow	10	880.00
62AC/4	10	0.025	7/16	Red	10	890.00
62AC/5-1	20	0.04	10/19	Orange	10	845.00
62AC/5	25	0.04	10/19	Blue	10	850.00
62AC/6	50	0.06	12/21	Black	10	825.00
62AC/7	100	0.10	14/23	Green	10	880.00
62AC/8	200	0.15	14/23	Brown	6	1125.00
62AC/9	250	0.15	14/23	White	6	1135.00
62AC/10	500	0.25	19/26	Yellow	5	1665.00
62AC/11	1000	0.40	24/29	Red	4	2450.00
62AC/12	2000	0.60	29/32	Brown	2	4515.00

**62 AQC** Amber Colour, Flask Volumetric "JSGW" with interchangeable Glass Penny Head Solid Stopper, with QR Code and Colour Coded, Accuracy as per Class 'A', with serialized individual works certificate.

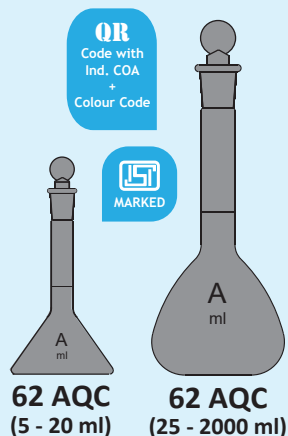

Cat. No.	Capacity ml.	Tolerance ± ml.	Stopper Size	Colour Code	Minimum Qty/Pack	Price/Piece (₹)
62AQC/3	5	0.025	7/16	Yellow	10	915.00
62AQC/4	10	0.025	7/16	Red	10	930.00
62AQC/5-1	20	0.04	10/19	Orange	10	880.00
62AQC/5	25	0.04	10/19	Blue	10	885.00
62AQC/6	50	0.06	12/21	Black	10	860.00
62AQC/7	100	0.10	14/23	Green	10	915.00
62AQC/8	200	0.15	14/23	Brown	6	1160.00
62AQC/9	250	0.15	14/23	White	6	1170.00
62AQC/10	500	0.25	19/26	Yellow	5	1695.00
62AQC/11	1000	0.40	24/29	Red	4	2485.00
62AQC/12	2000	0.60	29/32	Brown	2	4550.00

**63 U** Flask Volumetric "JSGW" with Glass Solid Stopper, Accuracy as per ASTM E288, **Class 'A' USP** (US Pharmacopeia) with individual serialized work certificate.

Cat. No.	Capacity ml.	Tolerance ± ml.	Stopper Size	Minimum Qty/Pack	Price/Piece (₹)
63U/1	1	0.02	7/16	10	780.00
63U/2	2	0.02	7/16	10	780.00
63U/3	5	0.02	7/16	10	765.00
63U/4	10	0.02	7/16	10	650.00
63U/5-1	20	0.03	10/19	10	615.00
63U/5	25	0.03	10/19	10	615.00
63U/6	50	0.05	12/21	10	635.00
63U/7	100	0.08	14/23	10	650.00
63U/8	200	0.10	14/23	6	875.00
63U/9	250	0.12	14/23	6	880.00
63U/10	500	0.20	19/26	5	1405.00
63U/11	1000	0.30	19/26	4	1955.00
63U/12	2000	0.50	29/32	4	3665.00

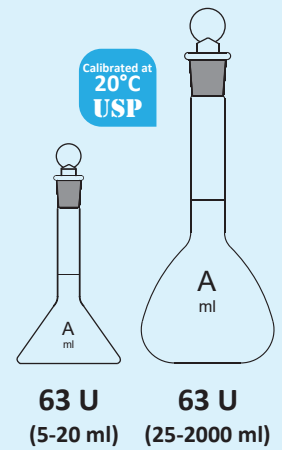

**63 UQ** Flask Volumetric "JSGW" with Glass Solid Stopper, with **QR Code**, Accuracy as per ASTM E288, **Class 'A' USP** (US Pharmacopeia) with individual serialized work certificate.

Cat. No.	Capacity ml.	Tolerance ± ml.	Stopper Size	Minimum Qty/Pack	Price/Piece (₹)
63UQ/3	5	0.02	7/16	10	830.00
63UQ/4	10	0.02	7/16	10	865.00
63UQ/5-1	20	0.03	10/19	10	685.00
63UQ/5	25	0.03	10/19	10	685.00
63UQ/6	50	0.05	12/21	10	715.00
63UQ/7	100	0.08	14/23	10	725.00
63UQ/8	200	0.10	14/23	6	950.00
63UQ/9	250	0.12	14/23	6	955.00
63UQ/10	500	0.20	19/26	5	1475.00
63UQ/11	1000	0.30	19/26	4	2075.00
63UQ/12	2000	0.50	29/32	4	3735.00

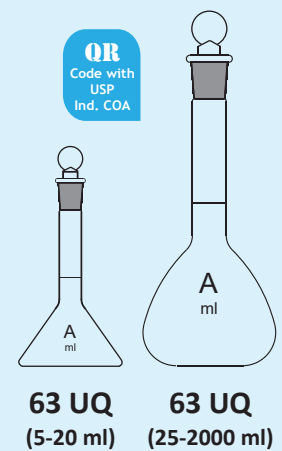

**63 UC** Flask Volumetric "JSGW" with Glass Solid Stopper, with **Colour Coded**, Accuracy as per ASTM E288, **Class 'A' USP** (US Pharmacopeia) with individual serialized work certificate.

Cat. No.	Capacity ml.	Tolerance ± ml.	Stopper Size	Colour Code	Minimum Qty/Pack	Price/Piece (₹)
63UC/3	5	0.02	7/16	Yellow	10	830.00
63UC/4	10	0.02	7/16	Red	10	865.00
63UC/5-1	20	0.03	10/19	Orange	10	685.00
63UC/5	25	0.03	10/19	Blue	10	685.00
63UC/6	50	0.05	12/21	Black	10	715.00
63UC/7	100	0.08	14/23	Green	10	725.00
63UC/8	200	0.10	14/23	Brown	6	950.00
63UC/9	250	0.12	14/23	White	6	955.00
63UC/10	500	0.20	19/26	Yellow	5	1475.00
63UC/11	1000	0.30	24/29	Red	4	2025.00
63UC/12	2000	0.50	29/32	Brown	2	3735.00

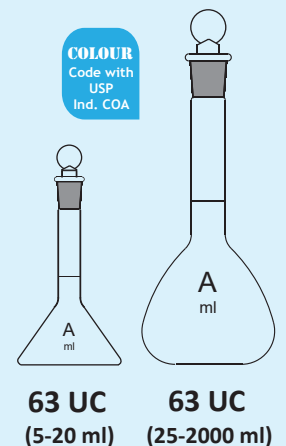

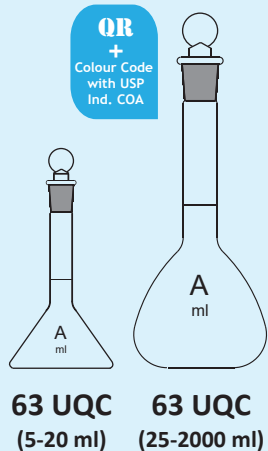

**63 UQC** Flask Volumetric "JSGW" with Glass Solid Stopper, with QR Code & Colour Coded, Accuracy as per ASTM E288, Class 'A' USP (US Pharmacopeia) with individual serialized work certificate.

Cat. No.	Capacity ml.	Tolerance ± ml.	Stopper Size	Colour Code	Minimum Qty/Pack	Price/Piece (₹)
63UQC/3	5	0.02	7/16	Yellow	10	865.00
63UQC/4	10	0.02	7/16	Red	10	905.00
63UQC/5-1	20	0.03	10/19	Orange	10	725.00
63UQC/5	25	0.03	10/19	Blue	10	725.00
63UQC/6	50	0.05	12/21	Black	10	750.00
63UQC/7	100	0.08	14/23	Green	10	760.00
63UQC/8	200	0.10	14/23	Brown	6	980.00
63UQC/9	250	0.12	14/23	White	6	990.00
63UQC/10	500	0.20	19/26	Yellow	5	1510.00
63UQC/11	1000	0.30	24/29	Red	4	2060.00
63UQC/12	2000	0.50	29/32	Brown	2	3775.00

**63 ASTM** Flask Volumetric "JSGW" with PTFE Knob Stopper, Accuracy as per ASTM E288, Class 'A' USP (US Pharmacopeia) with individual serialized work certificate.

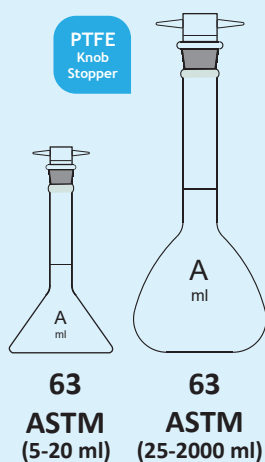

**NEW**

Cat. No.	Capacity ml.	Tolerance ± ml.	Stopper Size	Minimum Qty/Pack	Price/Piece (₹)
63ASTM/3	5	0.02	9	10	875.00
63ASTM/4	10	0.02	9	10	760.00
63ASTM/5-1	20	0.03	9	10	725.00
63ASTM/5	25	0.03	9	10	725.00
63ASTM/6	50	0.05	9	10	745.00
63ASTM/7	100	0.08	13	10	840.00
63ASTM/8	200	0.10	16	6	1125.00
63ASTM/9	250	0.12	16	6	1135.00
63ASTM/10	500	0.20	19	5	1660.00
63ASTM/11	1000	0.30	22	4	2355.00
63ASTM/12	2000	0.50	27	2	4225.00

**63UA** Amber Colour, Flask Volumetric "JSGW" with Glass Solid Stopper, Accuracy as per ASTM E288, Class 'A' USP (US Pharmacopeia) with individual serialized work certificate.

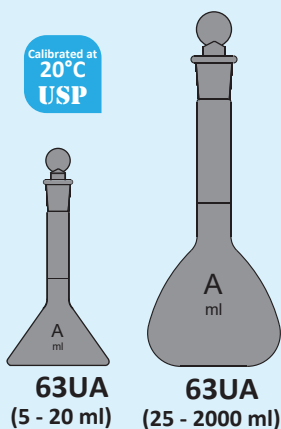

Cat. No.	Capacity ml.	Tolerance ± ml.	Stopper Size	Minimum Qty/Pack	Price/Piece (₹)
63UA/1	1	0.02	7/16	10	905.00
63UA/2	2	0.02	7/16	10	925.00
63UA/3	5	0.02	7/16	10	940.00
63UA/4	10	0.02	7/16	10	955.00
63UA/5-1	20	0.03	10/19	10	780.00
63UA/5	25	0.03	10/19	10	780.00
63UA/6	50	0.05	12/21	10	795.00
63UA/7	100	0.08	14/23	10	875.00
63UA/8	200	0.10	14/23	6	1070.00
63UA/9	250	0.12	14/23	6	1080.00
63UA/10	500	0.20	19/26	5	1710.00
63UA/11	1000	0.30	24/29	4	2415.00
63UA/12	2000	0.50	29/32	2	4515.00

**63UAQ** Amber Colour, Flask Volumetric "JSGW" with Glass Solid Stopper, with **QR Code**, Accuracy as per ASTM E288, **Class 'A' USP** (US Pharmacopeia) with individual serialized work certificate.

Cat. No.	Capacity ml.	Tolerance $\pm$ ml.	Stopper Size	Minimum Qty/Pack	Price/Piece (₹)
63UAQ/3	5	0.02	7/16	10	1005.00
63UAQ/4	10	0.02	7/16	10	1020.00
63UAQ/5-1	20	0.03	10/19	10	855.00
63UAQ/5	25	0.03	10/19	10	855.00
63UAQ/6	50	0.05	12/21	10	865.00
63UAQ/7	100	0.08	14/23	10	950.00
63UAQ/8	200	0.10	14/23	6	1140.00
63UAQ/9	250	0.12	14/23	6	1155.00
63UAQ/10	500	0.20	19/26	5	1780.00
63UAQ/11	1000	0.30	24/29	4	2485.00
63UAQ/12	2000	0.50	29/32	4	4590.00

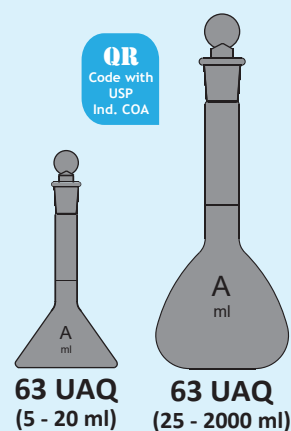

**63UAC** Amber Colour, Flask Volumetric "JSGW" with Glass Solid Stopper, with **Colour Code**, Accuracy as per ASTM E288, **Class 'A' USP** (US Pharmacopeia) with individual serialized work certificate.

Cat. No.	Capacity ml.	Tolerance $\pm$ ml.	Stopper Size	Colour Code	Minimum Qty/Pack	Price/Piece (₹)
63UAC/3	5	0.02	7/16	Yellow	10	1010.00
63UAC/4	10	0.02	7/16	Red	10	1025.00
63UAC/5-1	20	0.03	10/19	Orange	10	850.00
63UAC/5	25	0.03	10/19	Blue	10	850.00
63UAC/6	50	0.05	12/21	Black	10	865.00
63UAC/7	100	0.08	14/23	Green	10	950.00
63UAC/8	200	0.10	14/23	Brown	6	1140.00
63UAC/9	250	0.12	14/23	White	6	1155.00
63UAC/10	500	0.20	19/26	Yellow	5	1790.00
63UAC/11	1000	0.30	24/29	Red	4	2485.00
63UAC/12	2000	0.50	29/32	Brown	2	4590.00

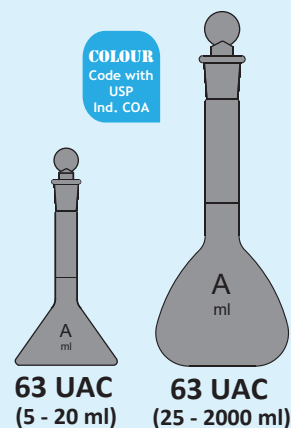

**63UAQC** Amber Colour, Flask Volumetric "JSGW" with Glass Solid Stopper, with **QR Code & Colour Coded**, Accuracy as per ASTM E288, **Class 'A' USP** (US Pharmacopeia) with individual serialized work certificate.

Cat. No.	Capacity ml.	Tolerance $\pm$ ml.	Stopper Size	Colour Code	Minimum Qty/Pack	Price/Piece (₹)
63UAQC/3	5	0.02	7/16	Yellow	10	1040.00
63UAQC/4	10	0.02	7/16	Red	10	1055.00
63UAQC/5-1	20	0.03	10/19	Orange	10	880.00
63UAQC/5	25	0.03	10/19	Blue	10	880.00
63UAQC/6	50	0.05	12/21	Black	10	895.00
63UAQC/7	100	0.08	14/23	Green	10	980.00
63UAQC/8	200	0.10	14/23	Brown	6	1175.00
63UAQC/9	250	0.12	14/23	White	6	1190.00
63UAQC/10	500	0.20	19/26	Yellow	5	1815.00
63UAQC/11	1000	0.30	24/29	Red	4	2520.00
63UAQC/12	2000	0.50	29/32	Brown	2	4625.00

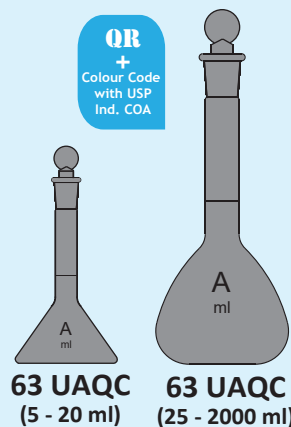

**63 ASTMA Amber Colour, Flask Volumetric "JSGW" with PTFE Knob Stopper, Accuracy as per ASTM E288, Class 'A' USP (US Pharmacopeia) with individual serialized work certificate.**

**NEW**

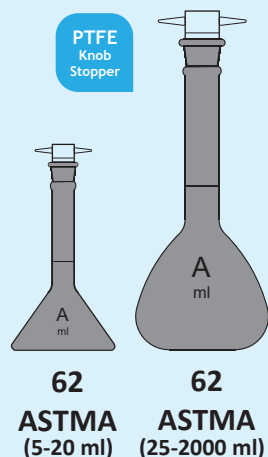

Cat. No.	Capacity ml.	Tolerance ± ml.	Stopper Size	Minimum Qty/Pack	Price/Piece (₹)
63ASTMA/3	5	0.02	9	10	1040.00
63ASTMA/4	10	0.02	9	10	1055.00
63ASTMA/5-1	20	0.03	9	10	880.00
63ASTMA/5	25	0.03	9	10	880.00
63ASTMA/6	50	0.05	9	10	890.00
63ASTMA/7	100	0.08	13	10	995.00
63ASTMA/8	200	0.10	16	6	1305.00
63ASTMA/9	250	0.12	16	6	1320.00
63ASTMA/10	500	0.20	19	5	1960.00
63ASTMA/11	1000	0.30	22	4	2795.00
63ASTMA/12	2000	0.50	27	2	4920.00

**63W** Flask Volumetric, **Wide Mouth** with interchangeable **Glass Penny Head Stopper**, Accuracy as per **Class 'A'**, with individual works Certificate.  
(These Flasks are suitable for testing bigger dia tablets without making it in powder form).

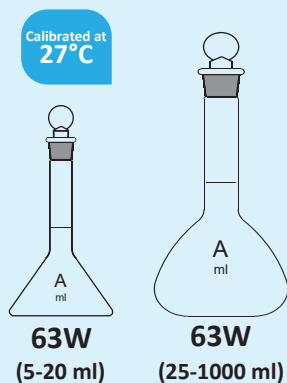

Cat. No.	Capacity ml.	Tolerance ± ml.	Stopper Size	Minimum Qty/Pack	Price/Piece (₹)
63W/3	5	0.04	10/19	10	650.00
63W/4	10	0.04	10/19	10	725.00
63W/5-1	20	0.06	12/21	10	625.00
63W/5	25	0.06	12/21	10	625.00
63W/6	50	0.10	14/23	10	650.00
63W/7	100*	0.10	19/26	10	685.00
63W/8	200*	0.15	19/26	6	890.00
63W/9	250*	0.15	19/26	6	890.00
63W/10	500*	0.25	24/29	5	1410.00
63W/11	1000	0.60	29/32	4	2060.00

\* Not covered in the standards.

**63WN** Flask Volumetric, **Wide Mouth** with interchangeable **Glass Penny Head Stopper**, Accuracy as per **Class 'A'**, with **NABL** individual works Certificate.  
(These Flasks are suitable for testing bigger dia tablets without making it in powder form).

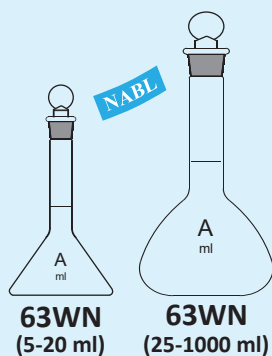

Cat. No.	Capacity ml.	Tolerance ± ml.	Stopper Size	Minimum Qty/Pack	Price/Piece (₹)
63WN/3	5	0.04	10/19	10	1040.00
63WN/4	10	0.04	10/19	10	1040.00
63WN/5-1	20	0.06	12/21	10	1040.00
63WN/5	25	0.06	12/21	10	1040.00
63WN/6	50	0.10	14/23	10	1040.00
63WN/7	100*	0.10	19/26	10	1105.00
63WN/8	200*	0.15	19/26	6	1550.00
63WN/9	250*	0.15	19/26	6	1550.00
63WN/10	500*	0.25	24/29	5	1745.00
63WN/11	1000	0.60	29/32	4	3010.00

\* Not covered in the standards.

**63WC** Flask Volumetric, **Wide Mouth** with interchangeable **Glass Penny Head Stopper**, with **Colour Coded**, Accuracy as per **Class 'A'**, with individual works Certificate. (These Flasks are suitable for testing bigger dia tablets without making it in powder form).

Cat. No.	Capacity ml.	Tolerance $\pm$ ml.	Stopper Size	Colour Code	Minimum Qty/Pack	Price/Piece (₹)
63WC/3	5	0.04	10/19	Yellow	10	725.00
63WC/4	10	0.04	10/19	Red	10	795.00
63WC/5-1	20	0.06	12/21	Orange	10	695.00
63WC/5	25	0.06	12/21	Blue	10	695.00
63WC/6	50	0.10	14/23	Black	10	725.00
63WC/7	100*	0.10	19/26	Green	10	760.00
63WC/8	200*	0.15	19/26	Brown	6	970.00
63WC/9	250*	0.15	19/26	White	6	970.00
63WC/10	500*	0.25	24/29	Yellow	5	1480.00
63WC/11	1000	0.60	29/32	Red	4	2135.00

\* Not covered in the standards.

**63WA** Amber Colour Flask Volumetric, **Wide Mouth** with interchangeable **Glass Penny Head Stopper**, Accuracy as per **Class 'A'**, with individual works Certificate.

(These Flasks are suitable for testing bigger dia tablets without making it in powder form).

Cat. No.	Capacity ml.	Tolerance $\pm$ ml.	Stopper Size	Minimum Qty/Pack	Price/Piece (₹)
63WA/3	5	0.04	10/19	10	865.00
63WA/4	10	0.04	10/19	10	885.00
63WA/5-1	20*	0.06	12/21	10	885.00
63WA/5	25	0.06	12/21	10	885.00
63WA/6	50	0.10	14/23	10	845.00
63WA/7	100*	0.10	19/26	10	930.00
63WA/8	200*	0.15	19/26	6	1250.00
63WA/9	250*	0.15	19/26	6	1290.00
63WA/10	500*	0.25	24/29	5	1890.00
63WA/11	1000	0.60	29/32	4	2615.00

\* Not covered in the standards.

**63WAC** Amber Colour, Flask Volumetric, **Wide Mouth** with **Glass Penny Head Stopper** with **Colour Coded**, Accuracy as per **Class 'A'**, with individual works Certificate. (These Flasks are suitable for testing bigger dia tablets without making it in powder form).

Cat. No.	Capacity ml.	Tolerance $\pm$ ml.	Stopper Size	Colour Code	Minimum Qty/Pack	Price/Piece (₹)
63WAC/3	5	0.04	10/19	Yellow	10	945.00
63WAC/4	10	0.04	10/19	Red	10	960.00
63WAC/5-1	20*	0.06	12/21	Orange	10	960.00
63WAC/5	25	0.06	12/21	Blue	10	960.00
63WAC/6	50	0.10	14/23	Black	10	925.00
63WAC/7	100*	0.10	19/26	Green	10	1010.00
63WAC/8	200*	0.15	19/26	Brown	6	1330.00
63WAC/9	250*	0.15	19/26	White	6	1370.00
63WAC/10	500*	0.25	24/29	Yellow	5	1890.00
63WAC/11	1000	0.60	29/32	Red	4	2685.00

\* Not covered in the standards.

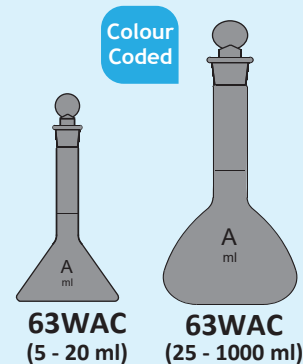
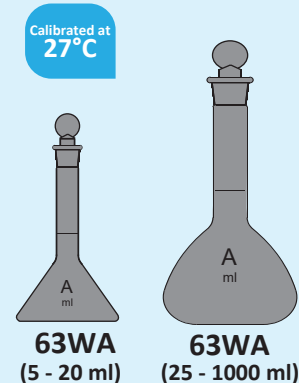
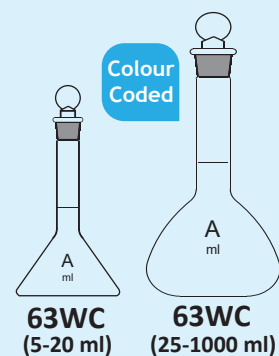

64 Flask Volumetric "JSGW" with Interchangeable Glass Stopper, Accuracy as per Class 'B'.

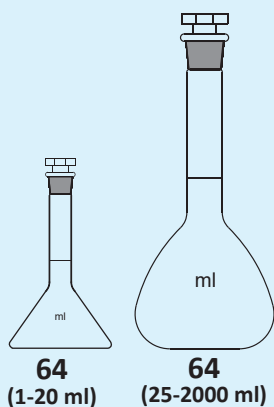

Cat. No.	Capacity ml.	Tolerance $\pm$ ml.	Stopper Size	Minimum Qty/Pack	Price/Piece (₹)
64/1	1	0.05	7/16	10	255.00
64/2	2	0.05	7/16	10	255.00
64/3	5	0.05	7/16	10	270.00
64/4	10	0.05	7/16	10	275.00
64/4-1	20	0.08	10/19	10	255.00
64/5	25	0.08	10/19	10	260.00
64/6	50	0.12	12/21	10	325.00
64/7	100	0.2	14/23	10	365.00
64/8	200	0.3	14/23	10	420.00
64/9	250	0.3	14/23	10	430.00
64/10	500	0.5	19/26	10	635.00
64/11	1000	0.8	24/29	4	990.00
64/12	2000	1.2	29/32	2	1910.00

64A Amber Colour, Flask Volumetric "JSGW" with Interchangeable Glass Stopper, Accuracy as per Class 'B'.

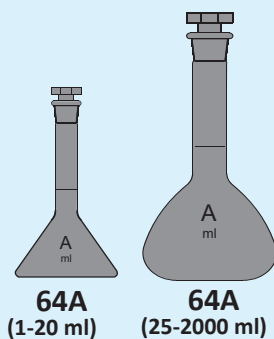

Cat. No.	Capacity ml.	Tolerance $\pm$ ml.	Stopper Size	Minimum Qty/Pack	Price/Piece (₹)
64A/1	1	0.05	7/16	10	465.00
64A/2	2	0.05	7/16	10	465.00
64A/3	5	0.05	7/16	10	450.00
64A/4	10	0.05	7/16	10	450.00
64A/4-1	20	0.08	10/19	10	470.00
64A/5	25	0.08	10/19	10	470.00
64A/6	50	0.12	12/21	10	530.00
64A/7	100	0.2	14/23	10	595.00
64A/8	200	0.3	14/23	10	680.00
64A/9	250	0.3	14/23	10	675.00
64A/10	500	0.5	19/26	10	960.00
64A/11	1000	0.8	24/29	4	1505.00
64A/12	2000	1.2	29/32	2	3050.00

65UW Flask Volumetric, Wide Mouth with interchangeable Glass Solid Stopper accuracy as per ASTM E288, Class 'A' USP (US Pharmacopeia) with certificate. (These Flasks are suitable for testing bigger dia tablets without making it in powder form).

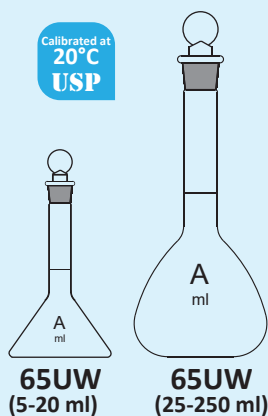

Cat. No.	Capacity ml.	Tolerance $\pm$ ml.	Stopper Size	Minimum Qty/Pack	Price/Piece (₹)
65UW/3	5	0.08	14/23	10	830.00
65UW/4	10	0.08	14/23	10	875.00
65UW/5-1	20*	0.08	14/23	10	695.00
65UW/5	25	0.08	14/23	10	695.00
65UW/6	50	0.08	14/23	10	715.00
65UW/7	100	0.10	19/26	10	725.00
65UW/8	200	0.20	19/26	6	955.00
65UW/9	250	0.20	19/26	6	955.00

\* Not covered in the standards.

**65UWA Amber Colour, Flask Volumetric, Wide Mouth** with I/C Glass Solid Stopper, accuracy as per ASTM E288, **Class 'A' USP (US Pharmacopeia)** with certificate. (These Flasks are suitable for testing bigger dia tablets without making it in powder form).

Cat. No.	Capacity ml.	Tolerance ± ml.	Stopper Size	Minimum Qty/Pack	Price/Piece (₹)
65UWA/3	5	0.08	14/23	10	995.00
65UWA/4	10	0.08	14/23	10	1025.00
65UWA/5-1	20*	0.08	14/23	10	860.00
65UWA/5	25	0.08	14/23	10	860.00
65UWA/6	50	0.08	14/23	10	955.00
65UWA/7	100	0.10	19/26	10	1025.00
65UWA/8	200	0.20	19/26	6	1235.00
65UWA/9	250	0.20	19/26	6	1240.00

\* Not covered in the standards.

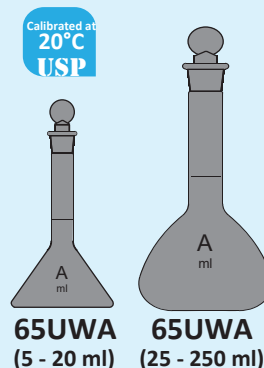

**66 Flasks Volumetric "JSGW" Sugar estimation with two marks, Class 'A' With Certificate.**

Cat. No.	Capacity ml.	Minimum Qty/Pack	Price/Piece (₹)
66/1	marked at 50 ml. and 55 ml.	2	530.00
66/2	– do – 100 ml. and 110 ml.	2	610.00
66/3	– do – 200 ml. and 220 ml.	2	740.00

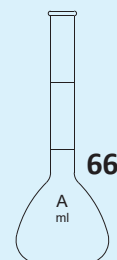

**67 Flasks Volumetric "JSGW" Sugar estimation with two marks.**

Cat. No.	Capacity ml.	Minimum Qty/Pack	Price/Piece (₹)
67/1	marked at 50 ml. and 55 ml.	2	315.00
67/2	– do – 100 ml. and 110 ml.	2	420.00
67/3	– do – 200 ml. and 220 ml.	2	490.00

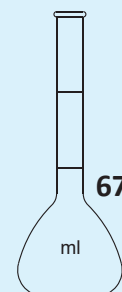

**68 Kohlrash Flasks (Mud Flask) "JSGW" with cup at top, Class 'A' with certificate.**

Cat. No.	Capacity ml.	Minimum Qty/Pack	Price/Piece (₹)
68/1	50	2	590.00
68/2	100	2	650.00
68/3	200	2	845.00

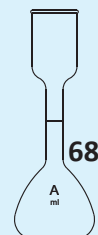

\* NOTE: Cat No. 66 & 68 can also be provided with NABL Certificate.

P.O.R.

**69 Kohlrash Flasks (Mud Flask) "JSGW" with cup at top.**

Cat. No.	Capacity ml.	Minimum Qty/Pack	Price/Piece (₹)
69/1	50	2	350.00
69/2	100	2	420.00
69/3	200	2	585.00

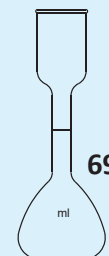

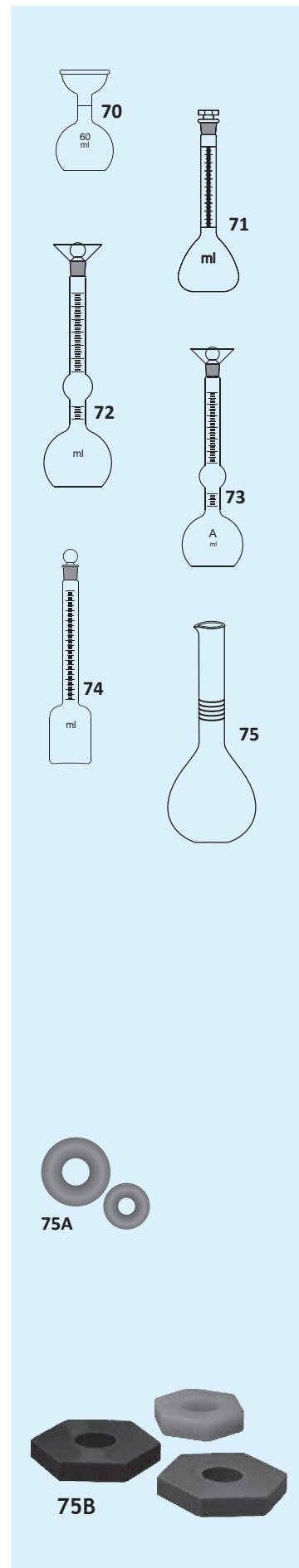

		Minimum Qty/Pack	Price/Piece (₹)
70	Saybolt Viscosity Flask, Capacity 60 ml. height 85 mm.	2	745.00
71	Cassia Flask, Capacity 100 ml. with graduated long neck.	2	1125.00
72	Lechatelier Flask, for Sp. Gr. Test, Bulb Capacity approx. 250 ml. neck graduation from 0 to 1 ml. and 18 to 24 ml. in 0.1 ml.	1	2365.00
73	Lechatelier Flask, for Sp. Gr. Test, Bulb Capacity approx. 250 ml. neck graduation from 0 to 1 ml. and 18 to 24 ml. in 0.1 ml. Tol. ± 0.05ml, with Certificate.	1	3270.00
74	Flask Sulphonation, with neck graduated 0 to 10 ml. and figured 0 to 100% for determination of olefin plus aromatic content.	1	1105.00
75	Jars, Measuring, with Pour Out, with Work Certificate	1	8490.00

\* NOTE: Cat No. 73 can also be provided with NABL Certificate.

P.O.R.

**75A Rings, Weight, Silicon Rubber, coated for Volumetric Flask**

Cat. No.	Size	Suitable For	Minimum Qty/Pack	Price/Piece (₹)
75A/1	Small	(5 ml - 50 ml)	5	655.00
75A/2	Large	(100 ml - 1 Ltr)	5	785.00

**75B Silicon Rubber, Safety Rider, Hexagonal Shape for Volumetric Flask.**

Cat. No.	Colour	Suitable For	Minimum Qty/Pack	Price/Piece (₹)
75B/1	Yellow	5 ml - 25 ml	10	65.00
75B/2	Green	50 ml	10	80.00
75B/3	Blue	100 ml - 250 ml	10	155.00
75B/4	Orange	500 ml	10	375.00
75B/5	Red	1000 ml	10	620.00

**75C Cleaning Brush, made from soft nylon, for Volumetric Flask.**

Cat. No.	Size	Price/10Pcs. (₹)
75C/1	Small	770.00
75C/2	Medium	1080.00
75C/3	Large	1080.00

**75D Cleaning Brush, made from soft nylon, for Laboratory Glassware.**

Cat. No.	Description	Price/10Pcs. (₹)
75D/1	Cleaning Brush 6 inch.	640.00
75D/2	Cleaning Brush 12 inch.	890.00
75D/3	Cleaning Brush 18 inch.	1210.00
75D/4	Test Tube Cleanig Brush Small (3ml to 25ml)	595.00
75D/5	Test Tube Cleanig Brush Medium (35ml to 75ml)	755.00
75D/6	Test Tube Cleanig Brush Large (100ml & 175ml)	930.00

## MEASURING CYLINDERS

76 Measuring Cylinders, "JSGW", with spout, Hexagonal Base, Accuracy as per Class 'A', with works certificate.

Cat. No.	Capacity ml.	Sub Div. ml.	Tolerance $\pm$ ml.	Minimum Qty/Pack	Price/Piece (₹)
76/1	5	0.1	0.05	6	480.00
76/2	10	0.2	0.1	6	530.00
76/3	25	0.5	0.25	6	590.00
76/4	50	1	0.5	6	740.00
76/5	100	1	0.5	6	865.00
76/6	250	2	1	4	1280.00
76/7	500	5	2.5	4	1840.00
76/8	1000	10	5	3	2325.00
76/9	2000	20	10	2	3835.00

76 Q Measuring Cylinders, "JSGW", with spout, Hexagonal Base, with QR Code, Accuracy as per Class 'A', with works certificate.

Cat. No.	Capacity ml.	Sub Div. ml.	Tolerance $\pm$ ml.	Minimum Qty/Pack	Price/Piece (₹)
76Q/1	5	0.1	0.05	6	560.00
76Q/2	10	0.2	0.1	6	600.00
76Q/3	25	0.5	0.25	6	675.00
76Q/4	50	1	0.5	6	810.00
76Q/5	100	1	0.5	6	955.00
76Q/6	250	2	1	4	1365.00
76Q/7	500	5	2.5	4	1910.00
76Q/8	1000	10	5	3	2400.00
76Q/9	2000	20	10	2	3905.00

76 N Measuring Cylinders, "JSGW", with spout, Hexagonal Base, Accuracy as per Class 'A', with NABL works certificate.

Cat. No.	Capacity ml.	Sub Div. ml.	Tolerance $\pm$ ml.	Minimum Qty/Pack	Price/Piece (₹)
76N/1	5	0.1	0.05	1	1150.00
76N/2	10	0.2	0.1	1	1175.00
76N/3	25	0.5	0.25	1	1210.00
76N/4	50	1	0.5	1	1335.00
76N/5	100	1	0.5	1	1450.00
76N/6	250	2	1	1	1805.00
76N/7	500	5	2.5	1	2450.00
76N/8	1000	10	5	1	2890.00
76N/9	2000	20	10	1	4665.00

76A Amber Colour Measuring Cylinders, "JSGW", with spout, Hexagonal Base, Accuracy as per Class 'A', with works certificate.

Cat. No.	Capacity ml.	Sub Div. ml.	Tolerance $\pm$ ml.	Minimum Qty/Pack	Price/Piece (₹)
76A/1	5	0.1	0.05	6	855.00
76A/2	10	0.2	0.1	6	1050.00
76A/3	25	0.5	0.25	6	1190.00
76A/4	50	1	0.5	6	1335.00
76A/5	100	1	0.5	6	1650.00
76A/6	250	2	1	4	2475.00
76A/7	500	5	2.5	4	3565.00
76A/8	1000	10	5	3	5050.00
76A/9	2000	20	10	2	8150.00

Calibrated at 27°C

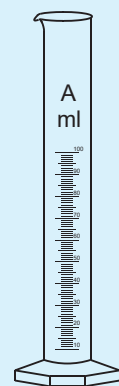

76

QR Code

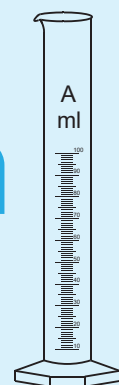

76

NABL

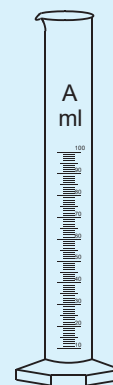

76 N

Calibrated at 27°C

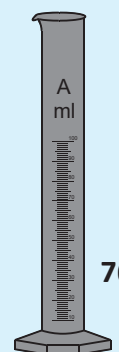

76A



**76 AN** Amber Colour Measuring Cylinders, "JSGW", with spout, Hexagonal Base, Accuracy as per **Class 'A'**, with **NABL** works certificate.

Cat. No.	Capacity ml.	Sub Div. ml.	Tolerance ± ml.	Minimum Qty/Pack	Price/Piece (₹)
76AN/1	5	0.1	0.05	1	1450.00
76AN/2	10	0.2	0.1	1	1550.00
76AN/3	25	0.5	0.25	1	1690.00
76AN/4	50	1	0.5	1	1835.00
76AN/5	100	1	0.5	1	2150.00
76AN/6	250	2	1	1	2975.00
76AN/7	500	5	2.5	1	4065.00
76AN/8	1000	10	5	1	5550.00

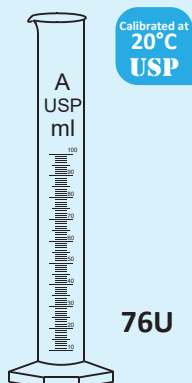

**76U** Measuring Cylinders "JSGW" with spout, Hexagonal Base, as per ASTM, **Class 'A' USP** (US Pharmacopeia) with certificate. Accuracy as per ASTM E1272.

Cat. No.	Capacity ml.	Sub Div. ml.	Tolerance ± ml.	Minimum Qty/Pack	Price/Piece (₹)
76U/1	5	0.1	0.05	6	525.00
76U/2	10	0.2	0.1	6	585.00
76U/3	25	0.5	0.17	6	635.00
76U/4	50	1	0.25	6	790.00
76U/5	100	1	0.5	6	975.00
76U/6	250	2	1.0	4	1470.00
76U/7	500	5	2.0	4	2100.00
76U/8	1000	10	3.0	3	2585.00
76U/9	2000	20	6.0	2	4135.00

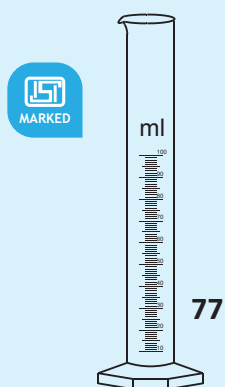

**77** Measuring Cylinders, "JSGW", with spout, Hexagonal Base, Accuracy as per **Class 'B'**

Cat. No.	Capacity ml.	Sub Div. ml.	Tolerance ± ml.	Minimum Qty/Pack	Price/Piece (₹)
77/1	5	0.1	0.1	6	335.00
77/2	10	0.2	0.2	6	355.00
77/3	25	0.5	0.5	6	415.00
77/4	50	1	1	6	455.00
77/5	100	1	1	6	525.00
77/6	250	2	2	4	915.00
77/7	500	5	5	4	1240.00
77/8	1000	10	10	3	1905.00
77/9	2000	20	20	2	3585.00

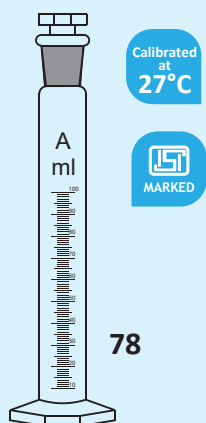

**78** Measuring Cylinders, "JSGW", with interchangeable stopper, Hexagonal Base, Accuracy as per **Class 'A'**, with works certificate.

Cat. No.	Capacity ml.	Sub Div. ml.	Tolerance ± ml.	Stopper size	Minimum Qty/Pack	Price/Piece (₹)
78/1	5	0.1	0.05	10/15	6	660.00
78/2	10	0.2	0.1	10/15	6	680.00
78/3	25	0.5	0.25	14/15	6	760.00
78/4	50	1	0.5	14/15	6	1005.00
78/5	100	1	0.5	19/20	6	1180.00
78/6	250	2	1	24/25	4	1875.00
78/7	500	5	2.5	24/25	4	2980.00
78/8	1000	10	5	34/25	3	3610.00
78/9	2000	20	10	34/25	2	5500.00

**78 N** Measuring Cylinders, "JSGW", with interchangeable stopper, Hexagonal Base, Accuracy as per **Class 'A'**, with **NABL** works certificate.

Cat. No.	Capacity ml.	Sub Div. ml.	Tolerance $\pm$ ml.	Stopper size	Minimum Qty/Pack	Price/Piece (₹)
78N/1	5	0.1	0.05	10/15	1	1250.00
78N/2	10	0.2	0.1	10/15	1	1280.00
78N/3	25	0.5	0.25	14/15	1	1330.00
78N/4	50	1	0.5	14/15	1	1485.00
78N/5	100	1	0.5	19/20	1	1595.00
78N/6	250	2	1	24/25	1	2075.00
78N/7	500	5	2.5	24/25	1	3145.00
78N/8	1000	10	5	34/25	1	3480.00
78N/9	2000	20	10	34/25	1	5910.00

**78A** Amber Colour Measuring Cylinders, "JSGW", with interchangeable stopper, Hexagonal Base, Accuracy as per **Class 'A'**, with works certificate.

Cat. No.	Capacity ml.	Sub Div. ml.	Tolerance $\pm$ ml.	Stopper size	Minimum Qty/Pack	Price/Piece (₹)
78A/1	5	0.1	0.05	10/15	2	1210.00
78A/2	10	0.2	0.1	10/15	2	1305.00
78A/3	25	0.5	0.25	14/15	2	1340.00
78A/4	50	1	0.5	14/15	2	1740.00
78A/5	100	1	0.5	19/20	2	2055.00
78A/6	250	2	1	24/25	2	3135.00
78A/7	500	5	2.5	24/25	1	4895.00
78A/8	1000	10	5	34/25	1	6670.00
78A/9	2000	20	10	34/25	1	9890.00

**78 AN** Amber Colour Measuring Cylinders, "JSGW", with interchangeable stopper, Hexagonal Base, Accuracy as per **Class 'A'**, with **NABL** works certificate.

Cat. No.	Capacity ml.	Sub Div. ml.	Tolerance $\pm$ ml.	Stopper size	Minimum Qty/Pack	Price/Piece (₹)
78AN/1	5	0.1	0.05	10/15	2	1710.00
78AN/2	10	0.2	0.1	10/15	2	1805.00
78AN/3	25	0.5	0.25	14/15	2	1840.00
78AN/4	50	1	0.5	14/15	2	2240.00
78AN/5	100	1	0.5	19/20	2	2555.00
78AN/6	250	2	1	24/25	2	3635.00
78AN/7	500	5	2.5	24/25	1	5395.00
78AN/8	1000	10	5	34/25	1	7170.00

**79** Measuring Cylinders, "JSGW", with interchangeable stopper, Hexagonal Base, Accuracy as per **Class 'B'**.

Cat. No.	Capacity ml.	Sub Div. ml.	Tolerance $\pm$ ml.	Minimum Qty/Pack	Price/Piece (₹)
79/1	5	0.1	0.1	6	485.00
79/2	10	0.2	0.2	6	515.00
79/3	25	0.5	0.5	6	530.00
79/4	50	1	1	6	650.00
79/5	100	1	1	6	780.00
79/6	250	2	2	4	1300.00
79/7	500	5	5	4	1830.00
79/8	1000	10	10	3	2720.00
79/9	2000	20	20	2	4350.00

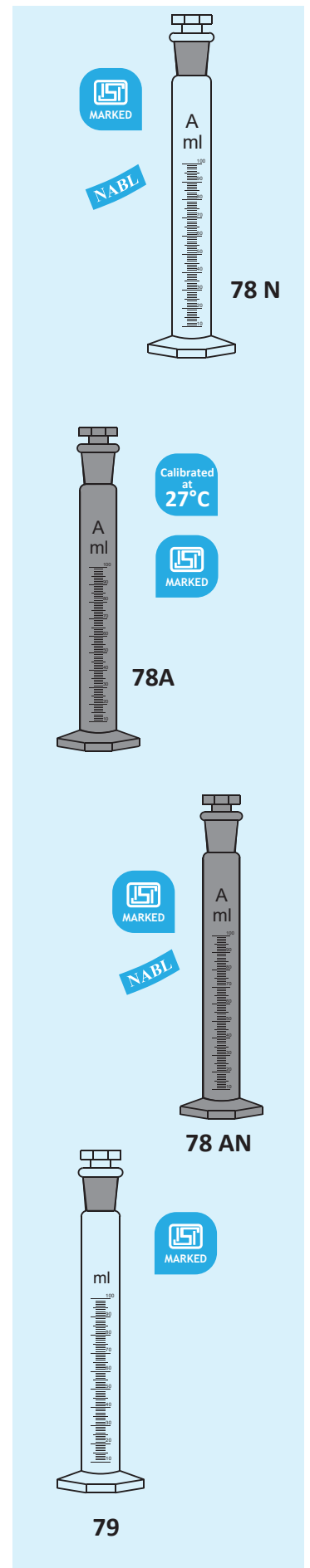

Calibrated  
at  
27°C

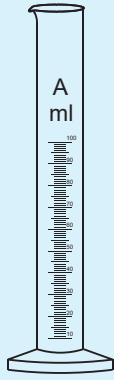

81

81 Measuring Cylinders, "JSGW", with spout, Round Base, Accuracy as per Class 'A', with works certificate.

Cat. No.	Capacity ml.	Sub Div. ml.	Tolerance ± ml.	Minimum Qty/Pack	Price/Piece (₹)
81/1	5	0.1	0.05	6	325.00
81/2	10	0.2	0.1	6	330.00
81/3	25	0.5	0.25	6	415.00
81/4	50	1	0.5	6	545.00
81/5	100	1	0.5	6	665.00
81/6	250	2	1	4	1205.00
81/7	500	5	2.5	4	2160.00
81/8	1000	10	5	3	2400.00
81/9	2000	20	10	2	3760.00

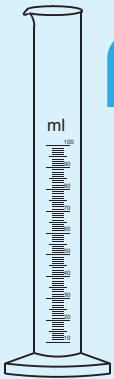

82

82 Measuring Cylinders, "JSGW", with spout, Round Base, Accuracy as per Class 'B'.

Cat. No.	Capacity ml.	Sub Div. ml.	Tolerance ± ml.	Minimum Qty/Pack	Price/Piece (₹)
82/1	5	0.1	0.1	6	235.00
82/2	10	0.2	0.2	6	260.00
82/3	25	0.5	0.5	6	325.00
82/4	50	1	1	6	360.00
82/5	100	1	1	6	445.00
82/6	250	2	2	4	855.00
82/7	500	5	5	4	1210.00
82/8	1000	10	10	3	1910.00
82/9	2000	20	20	2	3330.00

Calibrated  
at  
27°C



83

83 Measuring Cylinders, "JSGW", with interchangeable stopper, Round Base, Accuracy as per Class 'A', with works certificate.

Cat. No.	Capacity ml.	Sub Div. ml.	Tolerance ± ml.	Minimum Qty/Pack	Price/Piece (₹)
83/1	5	0.1	0.05	6	450.00
83/2	10	0.2	0.1	6	465.00
83/3	25	0.5	0.25	6	550.00
83/4	50	1	0.5	6	650.00
83/5	100	1	0.5	6	785.00
83/6	250	2	1	4	1415.00
83/7	500	5	2.5	4	2595.00
83/8	1000	10	5	3	2920.00
83/9	2000	20	10	2	4215.00

- 84 Measuring Cylinders, "JSGW", with interchangeable stopper, Round Base, Accuracy as per Class 'B'.

Cat. No.	Capacity ml.	Sub Div. ml.	Tolerance $\pm$ ml.	Minimum Qty/Pack	Price/Piece (₹)
84/1	5	0.1	0.1	6	325.00
84/2	10	0.2	0.2	6	335.00
84/3	25	0.5	0.5	6	445.00
84/4	50	1	1	6	520.00
84/5	100	1	1	6	660.00
84/6	250	2	2	4	1095.00
84/7	500	5	5	4	1665.00
84/8	1000	10	10	3	2380.00
84/9	2000	20	20	2	4070.00

- 85 Cylinder, Rain measure "JSGW", Metric Scale Graduated as per IS 4849 : 1992.

Cat. No.	Size mm.	Collector area cm <sup>2</sup>	Sub Div. ml.	Tolerance $\pm$ ml.	Minimum Qty/Pack	Price/Piece (₹)
85/1	20	200	0.2	0.05	12	1445.00
85/2	20	100	0.2	0.1	12	1240.00

- 86 Nessler Cylinder, "JSGW", for colour comparison, Class 'A' with works certificate, graduated.

Cat. No.	Capacity ml.	Sub Div. ml.	Tolerance $\pm$ ml.	Minimum Qty/Pack	Price/Piece (₹)
86/1	50	25 to 50	0.4	12	315.00
86/2	100	50 & 100	0.8	12	435.00

- 86 A Nessler Cylinder, "JSGW" for colour comparison, with interchangeable stopper Class 'A' with works certificate, graduated.

Cat. No.	Capacity ml.	Sub Div. ml.	Tolerance $\pm$ ml.	Stopper Size	Minimum Qty/Pack	Price/Piece (₹)
86A/1	50	25 to 50	0.4	19/20	12	480.00
86A/2	100	50 & 100	0.8	19/20	12	615.00

- 87 Nessler Cylinder, "JSGW", for colour comparison graduated.

Cat. No.	Capacity ml.	Sub Div. ml.	Minimum Qty/Pack	Price/Piece (₹)
87/1	50	25 & 50	12	195.00
87/2	100	50 & 100	12	260.00

For Nessler Cylinder Stands refer Cat. No. 1283A

- 88 Crow Receiver, "JSGW" Class 'A' with works certificate.

Cat. No.	Capacity ml.	Tolerance $\pm$ ml.	Minimum Qty/Pack	Price/Piece (₹)
88/1	25	0.04 & 0.1	2	630.00
88/2	50	0.1 & 0.2	2	800.00
88/3	100	0.2 & 0.4	2	975.00

- 88A Crow Receiver, "JSGW" with Interchangeable Stopper, Round Base, Class 'A' with works certificate.

Cat. No.	Capacity ml.	Tolerance $\pm$ ml.	Minimum Qty/Pack	Price/Piece (₹)
88A/1	25	0.04 & 0.1	2	820.00
88A/2	50	0.1 & 0.2	2	1035.00
88A/3	100	0.2 & 0.4	2	1245.00

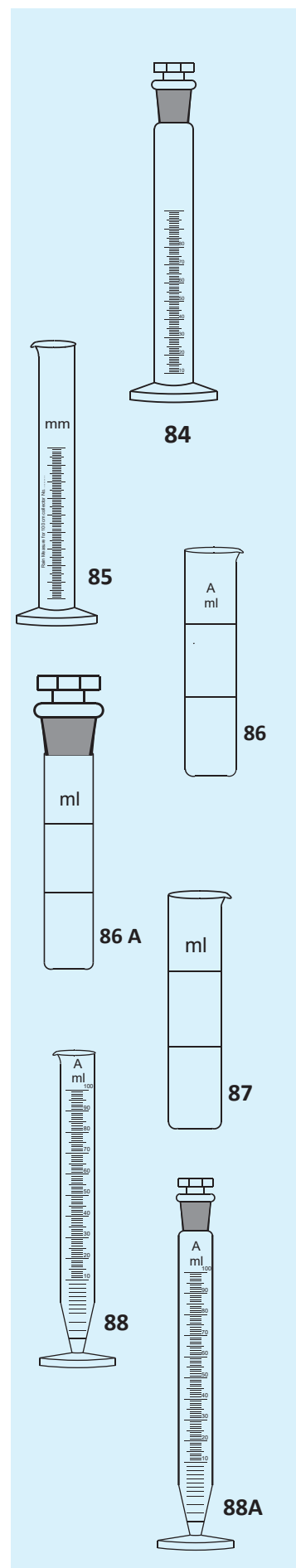

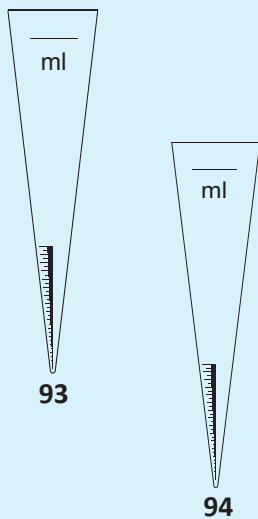
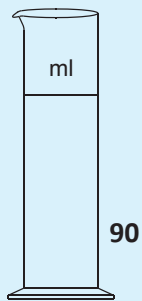

89 Crow Receiver, "JSGW" Class B.

Cat. No.	Capacity ml.	Minimum Qty/Pack	Price/Piece (₹)
89/1	25	2	525.00
89/2	50	2	630.00
89/3	100	2	830.00

89A Crow Receiver, "JSGW" with Interchangeable Stopper, Round Base, Class B.

Cat. No.	Capacity ml.	Minimum Qty/Pack	Price/Piece (₹)
89A/1	25	2	630.00
89A/2	50	2	725.00
89A/3	100	2	945.00

90 Cylinder "JSGW" with single graduation mark at 1000 ml for sedimentation of sand. 1715.00

91 Poly Propylene, Safety Rider, Hexagonal Shape for Measuring Cylinders.

Cat. No.	Suitable for	Price/10 Pcs. (₹)
91/1	5 ml	355.00
91/2	10 ml	355.00
91/3	25 ml	390.00
91/4	50 ml	425.00
91/5	100 ml	535.00
91/6	250 ml	640.00
91/7	500 ml	925.00
91/8	1000 ml	1205.00

## CONES

	Price/Piece (₹)
93 Cones, Imhoff, Sediment, Sharp Tip, "JSGW", Graduated from 0 to 1 ml in 0.1 ml. Division, 1 to 10 ml. in 0.5 ml. and 10 to 40 ml. in 1 ml. Also marked at 1000 ml. Approx. Total Height 454 mm., Approx. Top Dia 100 mm.	7090.00

94 Cones, Imhoff, Sediment, Blunt Tip, "JSGW", Graduated from 0 to 1 ml in 0.1 ml. division, 1 to 10 ml. in 0.5 ml. and 10 to 40 ml. in 1 ml., Approx. Top Dia 100 mm.	7090.00
--	---------

94 A Stand for Cones, Imhof, made of perpex sheet, 2 hole.	5085.00
--	---------

## TUBES

95 Tubes, Culture, Media, "JSGW", Round Bottom, with Screw Cap & PTFE liner.

Cat. No.	Capacity ml.	O.D. x Length mm. (approx)	Minimum Qty/Pack	Price/Piece (₹)
95/1	5	16 x 75	25	61.00
95/2	10	16 x 125	25	74.00
95/3	15	16 x 150	25	79.00
95/4	25	18 x 150	25	86.00
95/5	30	25 x 100	25	89.00
95/6	50	25 x 150	25	90.00
95/7	60	25 x 200	25	100.00
95/8	100	32 x 200	25	225.00
95/9	150	38 x 200	25	370.00

95A Amber Colour Culture, Tubes, Media, "JSGW", Round Bottom, with Screw Cap and PTFE liner.

Cat. No.	Capacity ml.	O.D. x Length mm. (approx.)	Minimum Qty/Pack	Price/Piece (₹)
95A/1	5	16 x 75	25	110.00
95A/2	10	16 x 125	25	124.00
95A/3	30	25 x 100	25	155.00
95A/4	50	25 x 150	25	189.00
95A/5	60	25 x 200	25	236.00
95A/6	100	32 x 200	25	378.00
95A/7	150	38 x 200	25	535.00

97 Tubes, Culture, Media, "JSGW", Flat Bottom, with Screw Cap and PTFE liner

Cat. No.	Capacity ml.	O.D. x Length mm. (approx)	Minimum Qty/Pack	Price/Piece (₹)
97/1	5	16 x 50	25	55.00
97/2	15	25 x 57	25	71.00
97/3	30	25 x 95	25	78.00
97/4	50	25 x 150	25	100.00
97/5	10	25 x 50	25	70.00
97/6	20	25 x 75	25	74.00

97A Amber Colour Culture, Tubes, Media, "JSGW", Flat Bottom, with Screw Cap and PTFE liner.

Cat. No.	Capacity ml.	O.D. x Length mm. (approx.)	Minimum Qty/Pack	Price/Piece (₹)
97A/1	5	16 x 50	25	110.00
97A/2	15	25 x 57	25	136.00
97A/3	30	25 x 95	25	156.00
97A/4	10	25 X 50	25	136.00
97A/5	20	25 X 75	25	150.00

100 Leighton Tubes, "JSGW", for Culture work, plain top with Cover slip.

Cat. No.	Length mm.	O.D. mm.	Windows Size (mm.)	Minimum Qty/Pack	Price/Piece (₹)
100/1	125	16	11x37	10	80.00
100/2	150	16	11x37	10	90.00

101 Leighton Tubes, "JSGW", for Culture work, with Screw Cap and Cover slip.

Cat. No.	Length mm.	O.D. mm.	Windows Size (mm.)	Minimum Qty/Pack	Price/Piece (₹)
101/1	125	16	11x37	10	120.00
101/2	150	16	11x37	10	125.00

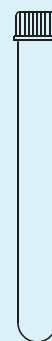

95



95A



97



97A



100



101

**102 Centrifuge Tube, "JSGW", Conical Bottom, **Graduated**.**

Cat. No.	Capacity ml.	O.D. x Length mm (approx)	Minimum Qty/Pack	Price/Piece (₹)
102/1	5	13x100	25	90.00
102/2	10	15x110	25	100.00
102/3	15	17x120	25	110.00
102/4	25	22x125	12	175.00
102/5	50	30x135	12	225.00

**103 Centrifuge Tube, "JSGW" Conical bottom, **Plain**.**

Cat. No.	Capacity ml.	O.D. x Length mm. (approx)	Minimum Qty/Pack	Price/Piece (₹)
103/1	3	10x76	25	37.00
103/2	5	13x100	25	41.00
103/3	10	15x110	25	50.00
103/4	12	16x110	25	50.00
103/5	15	17x120	25	55.00
103/6	25	22x125	12	150.00
103/7	50	30x135	12	190.00

**104 Centrifuge Tube, "JSGW", with **Screw Cap, Plain**.**

Cat. No.	Capacity ml.	Minimum Qty/Pack	Price/Piece (₹)
104/1	10	25	130.00
104/2	15	25	130.00
104/3	50	12	270.00

**105 Centrifuge Tube, "JSGW", with Screw Cap, **Graduated**.**

Cat. No.	Capacity ml.	Minimum Qty/Pack	Price/Piece (₹)
105/1	10	25	185.00
105/2	15	25	195.00
105/3	50	12	445.00

**106 Centrifuge Tube, "JSGW" Conical bottom, Graduated with interchangeable stopper.**

Cat. No.	Capacity ml.	Minimum Qty/Pack	Price/Piece (₹)
106/1	5	25	165.00
106/2	10	25	175.00
106/3	15	25	190.00
106/4	25	12	295.00
106/5	50	12	365.00

**107 Centrifuge Tube, "JSGW" Plain, with interchangeable stopper, conical or round bottom.**

Cat. No.	Capacity ml	Minimum Qty/Pack	Price/Piece (₹)
107/1	3	25	124.00
107/2	5	25	136.00
107/3	10	25	150.00
107/4	15	25	155.00
107/5	25	12	225.00

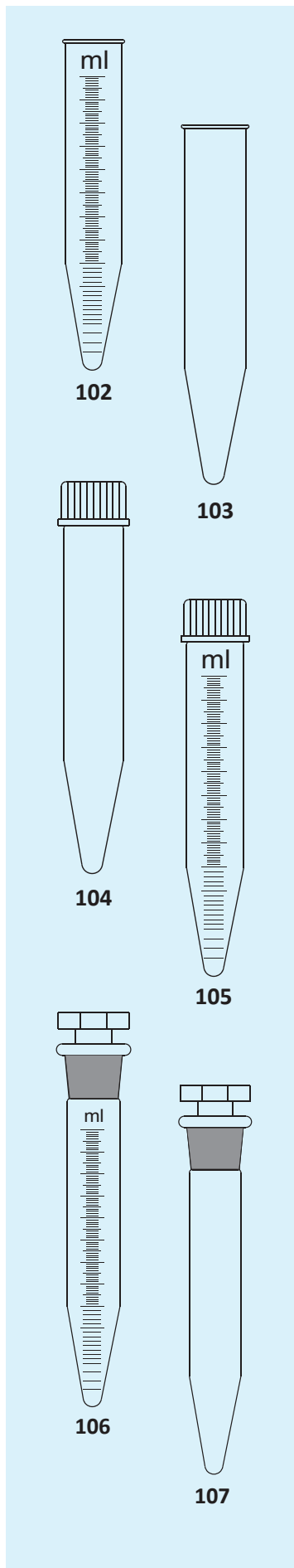

108 Centrifuge Tubes, "JSGW" Round bottom, graduated.

Cat. No.	Capacity ml.	O.D. x Length mm. (approx)	Minimum Qty/Pack	Price/Piece (₹)
108/1	12	16x110	10	130.00
108/2	30	24x110	6	150.00
108/3	40	28x110	6	185.00
108/4	50	30x110	6	205.00
108/5	100	45x110	6	580.00
108/6	200	55x116	6	690.00

110 Centrifuge Tubes "JSGW" fully graduated, Suitable for Solubility Test, Conical Bottom, Graduated, Cap : 50 ml, Length: 120 -125 mm Dia.30 mm with Graduation Mark 0-1 ml, 0.1ml, 1-2 ml, 0.2 ml, 2-10 ml, 0.5 ml, 10-20 ml, 1 ml & at 50 ml (₹) 745.00

111 Centrifuge Tubes, Oil, (Watering) as per ASTM D96, "JSGW" fully graduated 0 to 0.5 ml.in 0.05 ml. div., 0.5 to 2 ml. in 0.1 ml. Div., 2 ml. to 3 ml. In 0.2 ml. Div., 3 ml. to 5 ml. in 0.5 ml. Div., 5 ml. to 10 ml. in 1 ml. div., 10 ml. to 25 ml. in 5 ml. Div., graduations are marked at 50, 75 and 100 ml. (₹) 1320.00

112 Centrifuge Tubes, Oil, "JSGW" the lower stem is grad. 0 to 1.5 ml. in 0.1 ml. div., the body is grad. 1.5 ml. to 5 ml. in 0.5 ml. div., from 5 ml. to 10 ml. in 1 ml. div., grad. are also marked at 15, 20, 25, 50 and 100 ml. (₹) 1350.00

114 Test Tubes, "JSGW" Graduated, with interchangeable stopper.

Cat. No.	O.D.x Length mm (appx)	Capacity ml. (appx)	Stopper Size	Minimum Qty/Pack	Price/Piece (₹)
114/1	13x100	5	10/15	10	165.00
114/2	15x125	10	10/15	10	175.00
114/3	22x150	25	19/26	10	270.00
114/4	25x200	50	19/26	10	320.00
114/5	32x230	100	24/29	10	405.00
114/6	15x150	15	14/15	10	195.00
114/7	19x160	20	14/15	10	220.00
114/8	25x155	30	19/26	10	290.00

114 A Amber Colour Test Tubes, "JSGW" Graduated, with interchangeable stopper.

Cat. No.	O.D.x Length mm (appx)	Capacity ml. (appx)	Stopper Size	Minimum Qty/Pack	Price/Piece (₹)
114A/1	13x100	5	10/15	10	320.00
114A/2	15x125	10	10/15	10	355.00
114A/3	22x150	25	19/26	10	470.00
114A/4	25x200	50	19/26	10	500.00
114A/5	32x230	100	24/29	10	765.00
114A/6	15x150	15	14/15	10	380.00
114A/7	19x160	20	14/15	10	425.00
114A/8	25x155	30	19/26	10	485.00

115 Test Tubes, "JSGW", with Inter changeable Stopper.

Cat No.	O.D.x Length mm (appx)	Capacity ml (appx)	Stopper Size	Minimum Qty/Pack	Price/Pcs (₹)
115/1	13x100	5	10/15	10	110.00
115/2	15x125	10	10/15	10	130.00
115/3	18x150	20	14/15	10	150.00
115/4	25x150	25	19/26	10	180.00
115/5	25x200	50	19/26	10	220.00
115/6	32x230	100	24/29	10	305.00
115/7	38x230	150	24/29	10	340.00

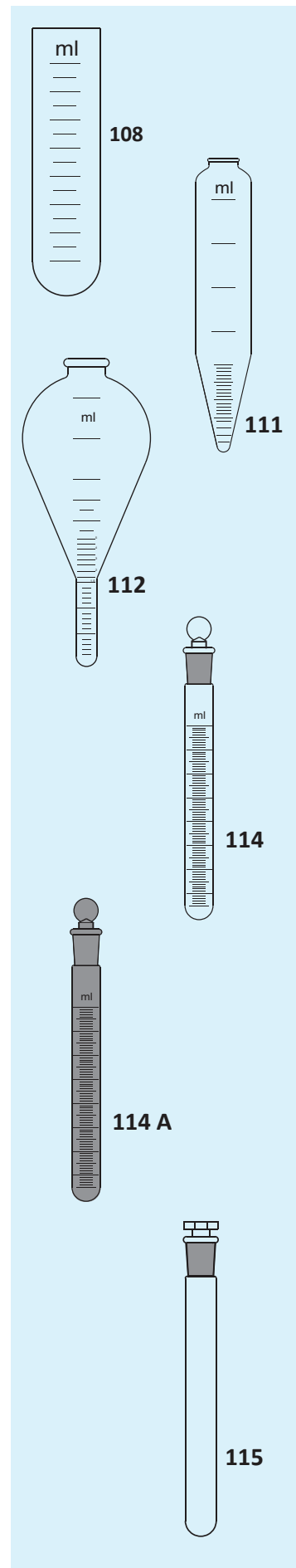

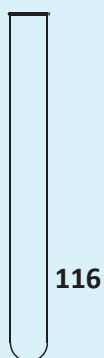

116

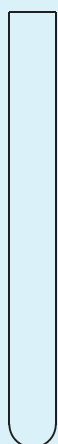

116A



117

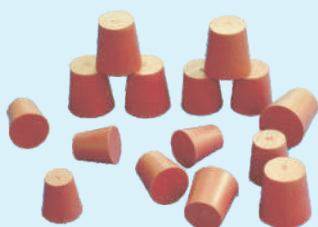

118

116 Test Tubes, "JSGW", made from Boro 3.3 exp. Glass Tubing, Round bottom, With Rim, Plain.

Cat. No.	Capacity ml (appx)	O.D. x Length Size	Minimum Qty/Pack	Price/Pcs (₹)
116/1	3	10x75	100	13.00
116/2	5	12x75	100	13.00
116/3	7	12x100	100	15.00
116/4	10	15x125	100	21.00
116/5	15	15x150	100	24.00
116/6	25	18x150	100	26.00
116/7	35	25x100	50	32.00
116/8	50	25x150	50	39.00
116/9	75	25x200	50	51.00
116/10	100	32x200	25	78.00
116/11	175	38x200	25	100.00

116A Test Tubes, "JSGW", made from Boro 3.3 exp. glass tubing, Round bottom, Rimless, Plain.

Cat. No.	Capacity ml (appx)	O.D. x Length Size	Minimum Qty/Pack	Price/Pcs (₹)
116A/1	3	10x75	100	13.00
116A/2	5	12x75	100	13.00
116A/3	7	12x100	100	15.00
116A/4	10	15x125	100	21.00
116A/5	15	15x150	100	24.00
116A/6	25	18x150	100	26.00
116A/7	35	25x100	50	32.00
116A/8	50	25x150	50	39.00
116A/9	75	25x200	50	51.00
116A/10	100	32x200	25	78.00
116A/11	175	38x200	25	100.00
116A/12	20	16x150	100	27.00
116A/13	12	16x100	100	18.00

117 Test Tubes, "JSGW", made from Boro 3.3 exp. glass tubing, Round Bottom, with Rim, Graduation in Amber colour.

Cat. No.	Capacity ml (appx)	O.D. x Length Size	Minimum Qty/Pack	Price/Piece (₹)
117/1	3	10x75	10	60.00
117/2	5	12x75	10	60.00
117/3	8	12x100	10	73.00
117/4	10	15x125	10	77.00
117/5	25	18x150	10	103.00
117/6	50	25x150	10	118.00
117/7	75	25x200	10	136.00

Note : For Test Tube Stands, Refer Cat. No. 1282

118 Rubber Cork for Test Tubes, Shore hardness 45-50A.

Cat. No.	Tube Size mm	Cork Top Dia (mm)	Bottom Dia (mm)	Height (mm)	Cork Number	Price/10 Pcs (₹)
118/1	10x75				00	43.00
118/2	12x75	13	9	15.5	0	45.00
118/3	12x100	13	9	15.5	0	45.00
118/4	15x125	16.5	13	20	2	67.00
118/5	15x150	16.5	13	20	2	67.00
118/6	18x150	19	14	21	3	81.00
118/7	25x100	26.5	21	27.5	8	180.00
118/8	25x150	26.5	21	27.5	8	180.00
118/9	25x200	26.5	21	27.5	8	180.00
118/11	38x200	41.5	32	42.5	14	550.00

## CONDENSERS

### 125 Air Condensers, "JSGW"

Cat. No.	Socket	Cone	Effective Length mm.	Minimum Qty/Pack	Price/Piece (₹)
125/1	14/23	14/23	200	4	285.00
125/2	19/26	19/26	200	4	335.00
125/3	24/29	24/29	250	4	460.00
125/4	19/26	19/26	400	4	505.00
125/5	24/29	24/29	500	4	645.00
125/6	34/35	34/35	500	4	1270.00
125/7	19/26	19/26	600	4	645.00
125/8	24/29	24/29	750	4	860.00
125/9	—	19/26	750	4	425.00
125/10	—	24/29	750	4	490.00
125/11	—	19/26	1000	4	500.00
125/12	—	24/29	1000	4	565.00

### 126 Liebig Condensers, "JSGW"

Cat. No.	Socket	Cone	Effective Length mm.	Minimum Qty/Pack	Price/Piece (₹)
126/1	14/23	14/23	150	4	405.00
126/2	19/26	19/26	200	4	465.00
126/3	24/29	24/29	200	4	535.00
126/4	19/26	19/26	300	4	560.00
126/5	24/29	24/29	300	4	630.00
126/6	19/26	19/26	350	4	655.00
126/7	24/29	24/29	350	4	670.00
126/8	19/26	19/26	400	4	680.00
126/9	24/29	24/29	400	4	700.00
126/10	24/29	24/29	500	4	855.00
126/11	24/29	24/29	600	4	955.00
126/12	24/29	24/29	750	4	1390.00
126/13	34/35	34/35	500	4	1585.00
126/14	34/35	34/35	600	4	1735.00
126/15	34/35	34/35	750	4	1855.00
126/16	34/35	34/35	900	4	2250.00
126/17	—	19/26	300	4	535.00
126/18	—	24/29	350	4	645.00
126/19	—	34/35	250	4	675.00
126/20	29/32	29/32	250	4	765.00
126/21	29/32	29/32	400	4	915.00
126/22	14/23	14/23	200	4	460.00

### 127 Coil Condensers, "JSGW" Graham, Coil Distillate Type.

Cat. No.	Socket	Cone	Effective Length mm.	Minimum Qty/Pack	Price/Piece (₹)
127/1	14/23	14/23	150	4	840.00
127/2	19/26	19/26	200	4	885.00
127/3	19/26	19/26	250	4	925.00
127/4	24/29	24/29	250	4	990.00
127/5	19/26	19/26	300	4	1015.00
127/6	24/29	24/29	300	4	1120.00
127/7	24/29	24/29	400	4	1205.00
127/8	24/29	24/29	500	4	1305.00
127/9	34/35	34/35	500	4	1775.00
127/10	34/35	34/35	600	4	1930.00

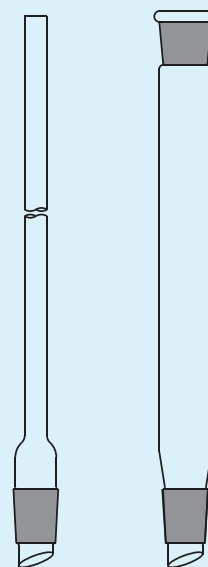

125

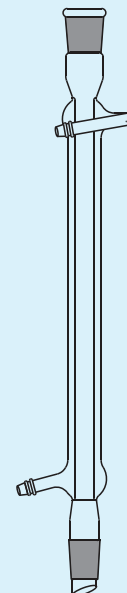

126

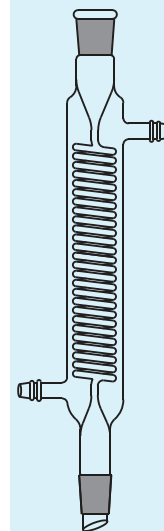

127

128 Coil Condensers, "JSGW" Graham, Jacket Distillate Type.

Cat. No.	Socket	Cone	Effective Length mm.	Minimum Qty/Pack	Price/Piece (₹)
128/1	14/23	14/23	150	4	840.00
128/2	19/26	19/26	200	4	885.00
128/3	19/26	19/26	250	4	925.00
128/4	24/29	24/29	250	4	990.00
128/5	19/23	19/23	300	4	1015.00
128/6	24/29	24/29	300	4	1120.00
128/7	24/29	24/29	400	4	1270.00
128/8	24/29	24/29	500	4	1305.00
128/9	34/35	34/35	500	4	1775.00
128/10	34/35	34/35	600	4	1930.00
128/11	29/32	29/32	165	4	955.00
128/12	29/32	29/32	320	4	1270.00

129 Reversible Type Condensers, "JSGW"

Cat. No.	Socket	Cone	Effective Length mm.	Minimum Qty/Pack	Price/Piece (₹)
129/1	—	19/26 & 24/29	150	4	995.00
129/2	—	24/29 & 24/29	150	4	1070.00
129/3	—	24/29 & 34/35	150	4	1185.00

130 Double Coil Condensers, "JSGW" with common inlet.

Cat. No.	Socket	Cone	Effective Length mm.	Minimum Qty/Pack	Price/Piece (₹)
130/1	19/26	19/26	200	4	2110.00
130/2	24/29	24/29	200	4	2155.00
130/3	34/35	34/35	350	4	5135.00
130/4	34/35	34/35	450	4	7730.00
130/5	34/35	34/35	600	4	8990.00

131 Davies Condensers, "JSGW" (Double Surface).

Cat. No.	Socket	Cone	Effective Length mm.	Minimum Qty/Pack	Price/Piece (₹)
131/1	19/26	19/26	150	4	1015.00
131/2	24/29	24/29	150	4	1020.00
131/3	19/26	19/26	200	4	1125.00
131/4	24/29	24/29	200	4	1150.00
131/5	29/32	29/32	200	4	1160.00
131/6	—	19/26	200	4	1055.00
131/7	—	24/29	200	4	1060.00
131/8	—	34/35	200	4	1125.00
131/9	—	19/26	250	4	1110.00
131/10	19/26	19/26	250	4	1175.00
131/11	24/29	24/29	250	4	1200.00
131/12	19/26	19/26	300	4	1340.00
131/13	24/29	24/29	300	4	1365.00
131/14	24/29	24/29	400	4	1535.00
131/15	24/29	24/29	500	4	2170.00
131/16	34/35	34/35	500	4	2315.00
131/17	34/35	34/35	600	4	2675.00

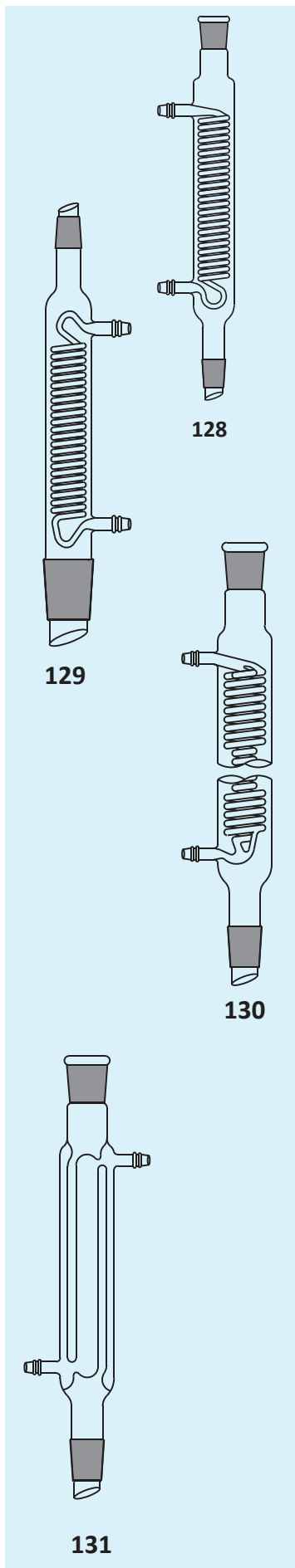

132 Jacketed Coil Condensers, "JSGW"

Cat. No.	Socket	Cone	Effective Length mm.	Minimum Qty/Pack	Price/Piece (₹)
132/1	19/26	19/26	150	4	1140.00
132/2	24/29	24/29	150	4	1140.00
132/3	—	34/35	150	4	1140.00
132/4	—	40/38	150	4	1235.00
132/5	19/26	19/26	200	4	1250.00
132/6	24/29	24/29	200	4	1270.00
132/7	19/26	19/26	300	4	1475.00
132/8	24/29	24/29	300	4	1485.00
132/9	24/29	24/29	400	4	1780.00
132/10	34/35	34/35	400	4	1945.00
132/11	34/35	34/35	500	4	2830.00
132/12	29/32	29/32	160	4	1215.00

133 Inland Revenue Condensers, "JSGW":

Cat. No.	Socket	Cone	Effective Length mm.	Minimum Qty/Pack	Price/Piece (₹)
133/1	19/26	19/26	200	4	1480.00
133/2	24/29	24/29	200	4	1510.00

134 Allihn Condensers, "JSGW" (Bulb Condenser).

Cat. No.	Socket	Cone	Effective Length mm.	Minimum Qty/Pack	Price/Piece (₹)
134/1	—	19/26	200	4	715.00
134/2	—	24/29	200	4	740.00
134/3	—	29/32	200	4	750.00
134/4	—	34/35	200	4	715.00
134/5	—	40/38	200	4	810.00
134/6	—	50/42	200	4	1040.00
134/7	—	50/42	250	4	1220.00
134/8	19/26	19/26	200	4	715.00
134/9	24/29	24/29	200	4	790.00
134/10	19/26	19/26	300	4	880.00
134/11	24/29	24/29	300	4	920.00
134/12	24/29	24/29	400	4	1060.00
134/13	24/29	24/29	500	4	1305.00
134/14	34/35	34/35	500	4	1450.00
134/15	34/35	34/35	600	4	1580.00
134/16	34/35	34/35	750	4	2820.00

135 Friedrich Condensers, "JSGW":

Cat. No.	Socket	Cone	Effective Length mm.	Minimum Qty/Pack	Price/Piece (₹)
135/2	19/26 or 24/29	19/26 or 24/29	200	2	2880.00
135/3	19/26 or 24/29	19/26 or 24/29	250	2	3085.00

136 Ether Condensers, "JSGW":

Cat. No.	Socket	Cone	Effective Length mm.	Minimum Qty/Pack	Price/Piece (₹)
136/1	19/26	24/29	150	2	3780.00
136/2	19/26 or 24/29	24/29	200	2	4010.00
136/3	19/26 or 24/29	24/29	250	2	4255.00

137 Cold Finger Condensers "JSGW" 130 mm. immersion, Cone 19/26. (₹) 335.00

145 Condensers, "JSGW", Bulb shape, suitable for 1000 ml., spoutless, Tall form, Beaker (₹) 800.00

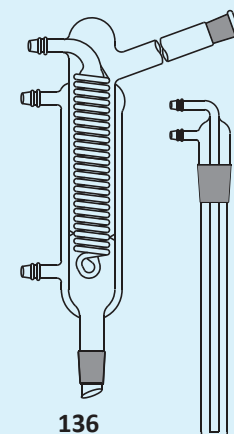
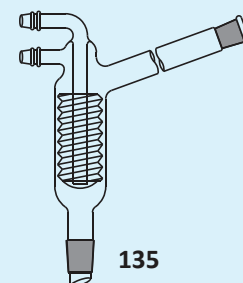
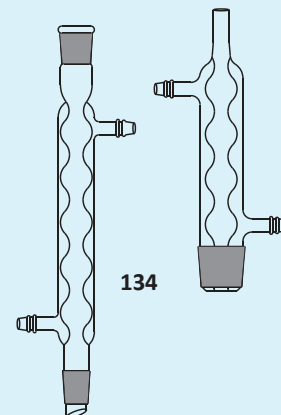
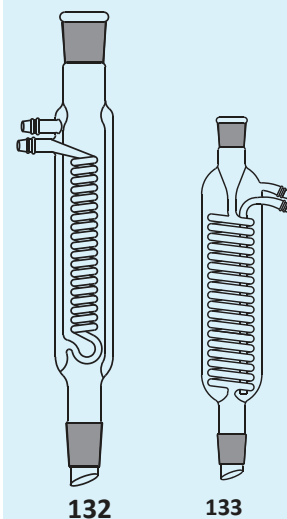

## FLASKS

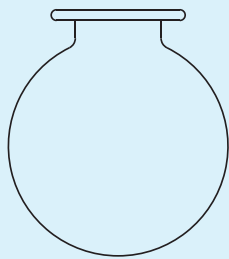

161

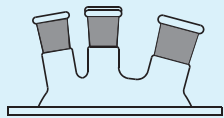

162

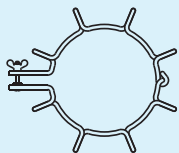

163



164

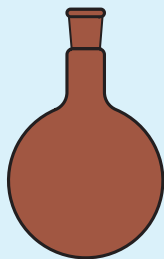

165A

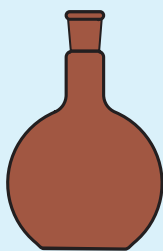

165B

### 161 Flasks Reaction, "JSGW", wide Mouth, Flat flange 100 mm. I.D., 150 mm. O.D.

Cat. No.	Capacity ml.	Minimum Qty/Pack	Price/Piece (₹)
161/1	1000	2	3595.00
161/2	2000	2	5115.00
161/3	3000	2	6380.00
161/4	5000	2	8575.00
161/5	10000	1	13170.00
161/6	20000	1	23250.00

### 162 Lids For Reaction Flasks, "JSGW", Flat flange 100 mm. I.D., 150 mm. O.D., with multiple Sockets.

Cat. No.	Central	Parallel	5°	10°	15°	Price/Piece (₹)
162/1	19/26	19/26	24/29	19/26	—	6315.00
162/2	19/26	14/23	14/23	14/23	29/32	6325.00
162/3	29/32	14/23	14/23	14/23	29/32	6645.00

### 163 Stainless Steel Clips, with wing nuts for holding 100 mm flat flanges.

1025.00

### 164 Teflon Gaskets, for 100 mm flat flange.

1085.00

### 165A Amber Colour Flasks, Round Bottom "JSGW", with Interchangeable Joint.

Cat. No.	Capacity ml.	Socket Size	Minimum Qty/Pack	Price/Piece (₹)
165A/1	25	19/26	12	495.00
165A/2	50	19/26	12	540.00
165A/3	100	24/29	12	770.00
165A/4	150	24/29	12	870.00
165A/5	250	24/29	12	985.00
165A/6	500	24/29	12	1405.00
165A/7	1000	24/29	6	1705.00
165A/8	2000	29/32	6	2945.00

### 165B Amber Colour Flasks, Flat Bottom "JSGW", with Interchangeable Joint.

Cat. No.	Capacity ml.	Socket Size	Minimum Qty/Pack	Price/Piece (₹)
165B/1	25	19/26	12	530.00
165B/2	50	19/26	12	580.00
165B/3	100	24/29	12	825.00
165B/4	150	24/29	12	930.00
165B/5	250	24/29	12	1055.00
165B/6	500	24/29	12	1505.00
165B/7	1000	24/29	6	1830.00
165B/8	2000	29/32	6	3155.00

165 Flasks Round Bottom, "JSGW", Short or Medium neck with Interchangeable Joint.

Cat. No.	Capacity ml.	Socket Size	Qty/Pack	Price/Piece (₹)
165/1	5	10/19	10	155.00
165/1A	5	14/23	10	155.00
165/2	10	10/19	10	155.00
165/2A	10	14/23	10	155.00
165/3	25	14/23	10	200.00
165/3A	25	19/26	10	200.00
165/4	25	24/29	10	215.00
165/5	50	14/23	10	230.00
165/5A	50	19/26	10	230.00
165/6	50	24/29	10	230.00
165/6A	50	29/32	10	230.00
165/7	50	34/35	10	250.00
165/8	100	14/23	10	255.00
165/8A	100	19/26	10	255.00
165/9	100	24/29	10	255.00
165/9A	100	29/32	10	255.00
165/10	100	34/35	2	255.00
165/11	150	19/26	10	285.00
165/12	150	24/29	10	285.00
165/13	150	29/32	2	285.00
165/13A	150	34/35	2	285.00
165/14	250	19/26	10	320.00
165/15	250	24/29	10	320.00
165/16	250	29/32	2	320.00
165/16A	250	34/35	2	320.00
165/17	500	19/26	2	450.00
165/18	500	24/29	2	450.00
165/19	500	29/32	2	450.00
165/19A	500	34/35	2	450.00
165/20	1000	24/29	2	645.00
165/21	1000	29/32	2	645.00
165/22	1000	34/35	2	645.00
165/23	2000	24/29	2	1830.00
165/23A	2000	29/32	2	1830.00
165/24	2000	34/35	2	1830.00
165/25	3000	24/29	1	3320.00
165/26	3000	34/35	1	3320.00
165/26A	3000	40/38	1	3320.00
165/27	5000	24/29	1	5010.00
165/27A	5000	34/35	1	5010.00
165/27B	5000	40/38	1	5010.00
165/28	5000	45/40	1	5010.00
165/28A	5000	50/42	1	5010.00
165/29	10000	34/35	1	9305.00
165/29A	10000	40/38	1	9305.00
165/30	10000	45/40	1	9305.00
165/30A	10000	50/42	1	9305.00
165/30B	10000	55/44	1	9305.00
165/31	20000	40/38	1	17435.00
165/31A	20000	50/42	1	17435.00
165/31B	20000	55/44	1	17435.00

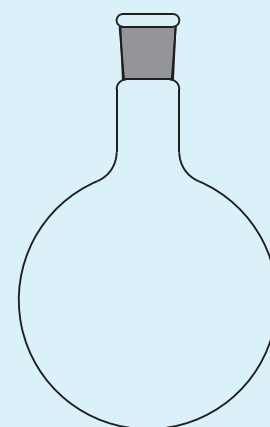

165

*Note : For long neck flasks 10% will be charged extra and also do mention the Short or Medium Neck, while placing order.*

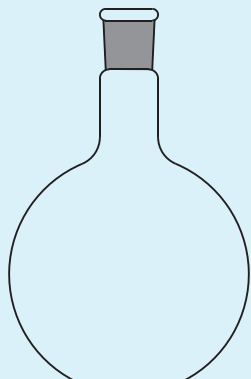

165 F

165F Flasks Flat Bottom, "JSGW", Short or Medium neck with Interchangeable Joint.

Cat. No.	Capacity ml.	Socket Size	Qty/Pack	Price/Piece (₹)
165F/1	5	10/19	10	155.00
165F/1A	5	14/23	10	155.00
165F/2	10	10/19	10	155.00
165F/2A	10	14/23	10	155.00
165F/3	25	14/23	10	200.00
165F/3A	25	19/26	10	200.00
165F/4	25	24/29	10	215.00
165F/5	50	14/23	10	230.00
165F/5A	50	19/26	10	230.00
165F/6	50	24/29	10	230.00
165F/7	50	34/35	10	250.00
165F/8	100	14/23	10	260.00
165F/8A	100	19/26	10	260.00
165F/9	100	24/29	10	260.00
165F/10	100	34/35	2	260.00
165F/11	150	19/26	10	285.00
165F/12	150	24/29	10	285.00
165F/13	150	29/32	2	285.00
165F/13A	150	34/35	2	285.00
165F/14	250	19/26	10	320.00
165F/15	250	24/29	10	320.00
165F/16	250	29/32	2	320.00
165F/16A	250	34/35	2	320.00
165F/16B	300	24/29	2	385.00
165F/17	500	19/26	2	450.00
165F/18	500	24/29	2	450.00
165F/19	500	29/32	2	450.00
165F/19A	500	34/35	2	450.00
165F/20	1000	24/29	2	645.00
165F/21	1000	29/32	2	645.00
165F/22	1000	34/35	2	645.00
165F/23	2000	24/29	2	1830.00
165F/23A	2000	29/32	2	1830.00
165F/24	2000	34/35	2	1830.00
165F/25	3000	24/29	1	3320.00
165F/26	3000	34/35	1	3320.00
165F/26A	3000	40/38	1	3320.00
165F/27	5000	24/29	1	5010.00
165F/27A	5000	34/35	1	5010.00
165F/27B	5000	40/38	1	5010.00
165F/28	5000	45/40	1	5010.00
165F/28A	5000	50/42	1	5010.00
165F/29	10000	34/35	1	9305.00
165F/29A	10000	40/38	1	9305.00
165F/30	10000	45/40	1	9305.00
165F/30A	10000	50/42	1	9305.00
165F/30B	10000	55/44	1	9305.00
165F/31	20000	40/38	1	17435.00
165F/31A	20000	50/42	1	17435.00
165F/31B	20000	55/44	1	17435.00

*Note : For long neck flasks 10% will be charged extra and also do mention the Short or Medium Neck, while placing order.*

166P Flasks Round Bottom, Two Neck "JSGW" (Side neck at parallel)

Cat. No.	Capacity ml.	Center Socket	Side Socket	Price/Piece (₹)
166P/1	100	24/29	14/23	360.00
166P/2	250	24/29	14/23	485.00
166P/3	250	24/29	19/26	485.00
166P/4	500	24/29	14/23	690.00
166P/5	500	24/29	19/26	690.00
166P/6	1000	34/35	14/23	1160.00
166P/6A	1000	34/35	19/26	1160.00
166P/6B	1000	24/29	14/23	1160.00
166P/6C	1000	24/29	19/26	1160.00
166P/7	2000	34/35	19/26	2325.00
166P/7A	2000	34/35	24/29	2325.00
166P/7B	2000	24/29	19/26	2325.00
166P/7C	2000	24/29	24/29	2325.00
166P/8	3000	34/35	24/29	4155.00
166P/8A	3000	34/35	19/26	4155.00
166P/8B	3000	34/35	14/23	4155.00
166P/8C	3000	24/29	24/29	4155.00
166P/8D	3000	24/29	19/26	4155.00
166P/8E	3000	24/29	14/23	4155.00
166P/9	5000	40/38	24/29	6090.00
166P/9A	5000	40/38	19/26	6090.00
166P/9B	5000	40/38	14/23	6090.00
166P/9C	5000	34/35	24/29	6090.00
166P/9D	5000	34/35	19/26	6090.00
166P/9E	5000	34/35	14/23	6090.00
166P/9F	5000	24/29	24/29	6090.00
166P/9G	5000	24/29	19/26	6090.00
166P/9H	5000	24/29	14/23	6090.00
166P/10	10000	55/44	34/35	10630.00
166P/10A	10000	55/44	24/29	10630.00
166P/10B	10000	55/44	19/26	10630.00
166P/10C	10000	50/42	34/35	10630.00
166P/10D	10000	50/42	24/29	10630.00
166P/10E	10000	50/42	19/26	10630.00
166P/11	20000	55/44	34/35	18235.00
166P/11A	20000	55/44	24/29	18235.00
166P/11B	20000	55/44	19/26	18235.00
166P/11C	20000	50/42	34/35	18235.00
166P/11D	20000	50/42	24/29	18235.00
166P/11E	20000	50/42	19/26	18235.00

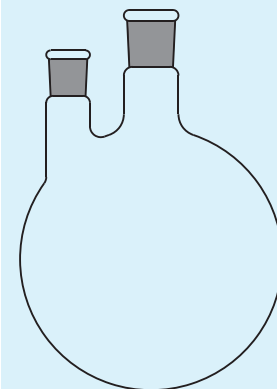

166-P

*Note : Flasks with other combination of necks can also be supplied.*

166A Flasks Round Bottom, Two Neck, "JSGW" (Side neck at angle).

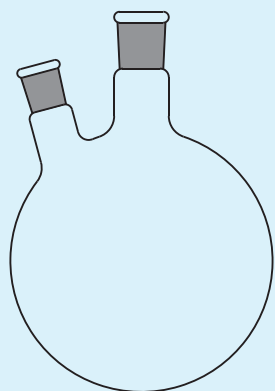

166 A

Cat. No.	Capacity ml.	Center Socket	Side Socket	Price/Piece (₹)
166A/1	100	24/29	14/23	360.00
166A/2	250	24/29	14/23	485.00
166A/3	250	24/29	19/26	485.00
166A/4	500	24/29	14/23	690.00
166A/5	500	24/29	19/26	690.00
166A/6	1000	34/35	14/23	1160.00
166A/6A	1000	34/35	19/26	1160.00
166A/6B	1000	24/29	14/23	1160.00
166A/6C	1000	24/29	19/26	1160.00
166A/7	2000	34/35	19/26	2325.00
166A/7A	2000	34/35	24/29	2325.00
166A/7B	2000	24/29	19/26	2325.00
166A/7C	2000	24/29	24/29	2325.00
166A/8	3000	34/35	24/29	4155.00
166A/8A	3000	34/35	19/26	4155.00
166A/8B	3000	34/35	14/23	4155.00
166A/8C	3000	24/29	24/29	4155.00
166A/8D	3000	24/29	19/26	4155.00
166A/8E	3000	24/29	14/23	4155.00
166A/9	5000	40/38	24/29	6090.00
166A/9A	5000	40/38	19/26	6090.00
166A/9B	5000	40/38	14/23	6090.00
166A/9C	5000	34/35	24/29	6090.00
166A/9D	5000	34/35	19/26	6090.00
166A/9E	5000	34/35	14/23	6090.00
166A/9F	5000	24/29	24/29	6090.00
166A/9G	5000	24/29	19/26	6090.00
166A/9H	5000	24/29	14/23	6090.00
166A/10	10000	55/44	34/35	10630.00
166A/10A	10000	55/44	24/29	10630.00
166A/10B	10000	55/44	19/26	10630.00
166A/10C	10000	50/42	34/35	10630.00
166A/10D	10000	50/42	24/29	10630.00
166A/10E	10000	50/42	19/26	10630.00
166A/11	20000	55/44	34/35	18235.00
166A/11A	20000	55/44	24/29	18235.00
166A/11B	20000	55/44	19/26	18235.00
166A/11C	20000	50/42	34/35	18235.00
166A/11D	20000	50/42	24/29	18235.00
166A/11E	20000	50/42	19/26	18235.00
166A/20A	25	19/26	14/23	370.00
166A/20B	25	24/29	19/26	370.00
166A/21A	50	19/26	14/23	405.00
166A/21B	50	24/29	19/26	405.00

Note : Flasks with other combination of necks can also be supplied.

167P Flask Round Bottom, Three Neck,"JSGW", side necks at parallel.

Cat. No.	Capacity ml.	Center Socket	Side Sockets	Price/Piece (₹)
167P/1	100	24/29	14/23	495.00
167P/2	250	24/29	14/23	635.00
167P/2A	250	24/29	19/26	635.00
167P/3	500	24/29	14/23	955.00
167P/3A	500	24/29	19/26	955.00
167P/4	1000	24/29	14/23	1375.00
167P/4A	1000	24/29	19/26	1375.00
167P/5	1000	34/35	19/26	1375.00
167P/6	2000	24/29	19/26	2525.00
167P/7	2000	34/35	19/26	2525.00
167P/8	2000	34/35	24/29	2525.00
167P/9	3000	34/35	19/26	5315.00
167P/9A	3000	34/35	24/29	5315.00
167P/10	5000	34/35	19/26	7310.00
167P/10A	5000	40/38	19/26	7310.00
167P/10B	5000	50/42	19/26	7310.00
167P/10C	5000	55/44	19/26	7310.00
167P/10D	5000	34/35	24/29	7310.00
167P/10E	5000	40/38	24/29	7310.00
167P/10F	5000	50/42	24/29	7310.00
167P/10G	5000	55/44	24/29	7310.00
167P/11A	10000	34/35	19/26	12460.00
167P/11B	10000	40/38	19/26	12460.00
167P/11C	10000	50/42	19/26	12460.00
167P/11D	10000	55/44	19/26	12460.00
167P/11E	10000	34/35	24/29	12460.00
167P/11G	10000	50/42	24/29	12460.00
167P/11H	10000	55/44	24/29	12460.00
167P/12A	20000	34/35	19/26	21900.00
167P/12C	20000	50/42	19/26	21900.00
167P/12D	20000	55/44	19/26	21900.00
167P/12E	20000	34/35	19/26	21900.00
167P/12F	20000	34/35	24/29	21900.00
167P/12H	20000	50/42	24/29	21900.00
167P/12 I	20000	55/44	24/29	21900.00

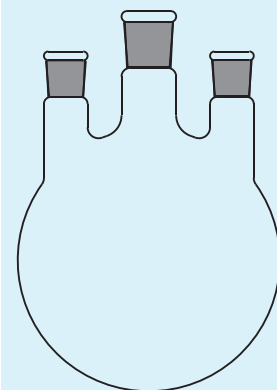

167-P

167A Flask Round Bottom, Three Neck,"JSGW", side necks at angle.

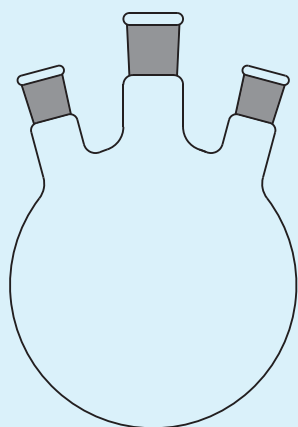

167 A

Cat. No.	Capacity ml.	Center Socket	Side Sockets	Price/Piece (₹)
167A/1	100	24/29	14/23	495.00
167A/2	250	24/29	14/23	635.00
167A/2A	250	24/29	19/26	635.00
167A/3	500	24/29	14/23	955.00
167A/3A	500	24/29	19/26	955.00
167A/4	1000	24/29	14/23	1375.00
167A/4A	1000	24/29	19/26	1375.00
167A/5	1000	34/35	19/26	1375.00
167A/6	2000	24/29	19/26	2525.00
167A/7	2000	34/35	19/26	2525.00
167A/8	2000	34/35	24/29	2595.00
167A/9	3000	34/35	19/26	5315.00
167A/9A	3000	34/35	24/29	5315.00
167A/10	5000	34/35	19/26	7310.00
167A/10A	5000	40/38	19/26	7310.00
167A/10B	5000	50/42	19/26	7310.00
167A/10C	5000	55/44	19/26	7310.00
167A/10D	5000	34/35	24/29	7310.00
167A/10E	5000	40/38	24/29	7310.00
167A/10F	5000	50/42	24/29	7310.00
167A/10G	5000	55/44	24/29	7310.00
167A/11A	10000	34/35	19/26	12460.00
167A/11B	10000	40/38	19/26	12460.00
167A/11C	10000	50/42	19/26	12460.00
167A/11D	10000	55/44	19/26	12460.00
167A/11E	10000	34/35	24/29	12460.00
167A/11G	10000	50/42	24/29	12460.00
167A/11H	10000	55/44	24/29	12460.00
167A/12A	20000	34/35	19/26	21900.00
167A/12C	20000	50/42	19/26	21900.00
167A/12D	20000	55/44	19/26	21900.00
167A/12E	20000	34/35	19/26	21900.00
167A/12F	20000	34/35	24/29	21900.00
167A/12H	20000	50/42	24/29	21900.00
167A/12 I	20000	55/44	24/29	21900.00
167A/21A	50	19/26	14/23	530.00
167A/21B	50	24/29	19/26	530.00

**167B** Flask Round Bottom, Four Neck, "JSGW", Center Neck and three Angled side Neck with Inter changeable Joints.

Cat. No.	Capacity ml.	Center Socket	Side Sockets	Price/Piece (₹)
167B/1	100	24/29	14/23	815.00
167B/2	100	24/29	19/26	815.00
167B/3	250	24/29	14/23	975.00
167B/4	250	24/29	19/26	975.00
167B/5	500	24/29	14/23	1405.00
167B/6	500	24/29	19/26	1405.00
167B/7	500	24/29	24/29	1405.00
167B/8	500	34/35	24/29	1405.00
167B/9	1000	24/29	14/23	1855.00
167B/10	1000	24/29	19/26	1855.00
167B/11	1000	24/29	24/29	1855.00
167B/11A	1000	34/35	24/29	1855.00
167B/12	2000	24/29	14/23	3050.00
167B/13	2000	24/29	19/26	3050.00
167B/14	2000	34/35	19/26	3050.00
167B/15	2000	34/35	24/29	3050.00
167B/16	3000	34/35	19/26	5845.00
167B/17	3000	34/35	24/29	5845.00
167B/18	5000	34/35	19/26	8370.00
167B/19	5000	34/35	24/29	8370.00
167B/20	10000	55/44	24/29	16055.00
167B/21	20000	55/44	24/29	24190.00

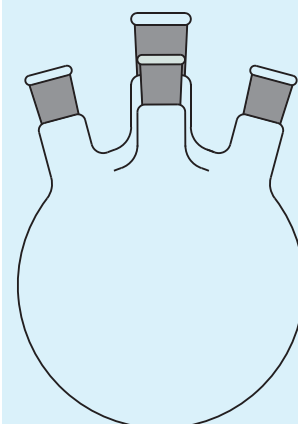

**167B**

**167C** Flask Round Bottom, Four Neck, "JSGW", Center Neck and three Parallel side Neck with Inter changeable Joints.

Cat. No.	Capacity ml.	Center Socket	Side Sockets	Price/Piece (₹)
167C/1	100	24/29	14/23	815.00
167C/2	100	24/29	19/26	815.00
167C/3	250	24/29	14/23	975.00
167C/4	250	24/29	19/26	975.00
167C/5	500	24/29	14/23	1405.00
167C/6	500	24/29	19/26	1405.00
167C/7	500	24/29	24/29	1405.00
167C/8	500	34/35	24/29	1405.00
167C/9	1000	24/29	14/23	1855.00
167C/10	1000	24/29	19/26	1855.00
167C/11	1000	24/29	24/29	1855.00
167C/11A	1000	34/35	24/29	1855.00
167C/12	2000	24/29	14/23	3050.00
167C/13	2000	24/29	19/26	3050.00
167C/14	2000	34/35	19/26	3050.00
167C/15	2000	34/35	24/29	3050.00
167C/16	3000	34/35	19/26	5845.00
167C/17	3000	34/35	24/29	5845.00
167C/18	5000	34/35	19/26	8370.00
167C/19	5000	34/35	24/29	8370.00
167C/20	10000	55/44	24/29	16055.00
167C/21	20000	55/44	24/29	24190.00

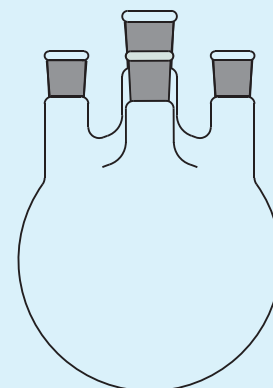

**167C**

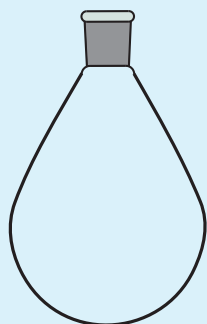

168A

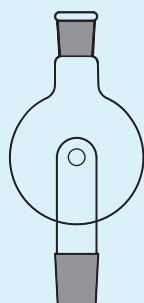

168B

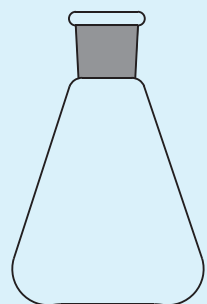

168

**168A Flasks Pear Shape, "JSGW", Suitable for Rotary Evaporators with Ground Socket.**

Cat. No.	Capacity ml.	Socket Size	Minimum Qty/Pack	Price/Piece (₹)
168A/1	50	24/29	2	535.00
168A/2	100	24/29	2	650.00
168A/3	250	24/29	2	915.00
168A/4	500	24/29	2	1155.00
168A/5	800	24/29	2	1695.00
168A/6	50	29/32	2	645.00
168A/7	100	29/32	2	815.00
168A/8	250	29/32	2	1085.00
168A/9	500	29/32	2	1390.00
168A/10	800	29/32	2	1955.00
168A/11	1000	29/32	2	2225.00
168A/12	2000	24/29	2	4260.00
168A/13	2000	29/32	2	4470.00

**168B Splash Head Adapters, "JSGW", for Rotavaps Anticlamp without return hole.**

Cat. No.	Bulb Cap. ml.	Socket Size	Cone Size	Price/Piece (₹)
168B/1	100	29/32	14/23	785.00
168B/1A	100	29/32	19/26	785.00
168B/1B	100	29/32	24/29	785.00
168B/2	250	29/32	14/23	1025.00
168B/2A	250	29/32	19/26	1025.00
168B/2B	250	29/32	24/29	1025.00
168B/3	500	29/32	14/23	1470.00
168B/3A	500	29/32	19/26	1470.00
168B/3B	500	29/32	24/29	1470.00

**168 Flask Conical, "JSGW", Erlenmeyer, with socket**

Cat. No.	Capacity ml.	Socket Size	Minimum Qty/Pack	Price/Piece (₹)
168/1	25	14/23	12	225.00
168/1A	25	19/26	12	225.00
168/2	50	14/23	12	230.00
168/3	50	19/26	12	230.00
168/4	100	19/26	12	295.00
168/5	100	24/29	12	295.00
168/5A	100	29/32	12	295.00
168/6	150	19/26	12	320.00
168/7	150	24/29	12	320.00
168/8	250	19/26	12	335.00
168/9	250	24/29	12	335.00
168/10	250	29/32	12	335.00
168/10A	250	34/35	12	420.00
168/11	500	19/26	12	480.00
168/12	500	24/29	12	480.00
168/13	500	29/32	12	480.00
168/13A	500	34/35	12	500.00
168/14	1000	24/29	6	920.00
168/15	1000	29/32	6	920.00
168/15A	1000	34/35	6	920.00
168/16	2000	24/29	4	1830.00
168/16A	2000	34/35	4	1830.00

169 Flasks Buchner, "JSGW", Filtering, Heavy wall, with Tubulation and socket.

Cat. No.	Capacity ml.	Socket Size	Minimum Qty/Pack	Price/Piece (₹)
169/1	100	19/26	12	485.00
169/2	250	24/29	12	845.00
169/3	500	24/29	12	1005.00
169/4	1000	24/29	6	1745.00
169/5	1000	34/35	6	1765.00
169/6	2000	34/35	4	3220.00

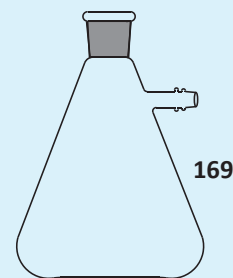

170 Flasks Kjeldahl, "JSGW" with Socket.

Cat. No.	Capacity ml.	Socket	Minimum Qty/Pack	Price/Piece (₹)
170/1	50	19/26	6	350.00
170/2	100	19/26	6	420.00
170/3	100	24/29	6	420.00
170/4	300	24/29	6	585.00
170/5	500	24/29	6	995.00
170/6	800	24/29	6	1150.00
170/7	800	29/32	6	1150.00

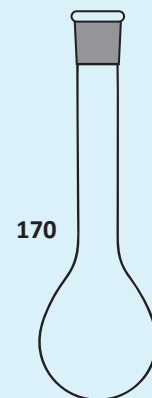

171 Flasks Pear Shaped, "JSGW", Single neck.

Cat. No.	Capacity ml.	Socket	Price/Piece (₹)
171/1	5	10/19	170.00
171/2	10	10/19	190.00
171/2A	10	14/23	190.00
171/3	25	10/19	225.00
171/3A	25	14/23	225.00
171/4	50	19/26	285.00
171/4A	50	14/23	285.00
171/5	100	14/23	405.00
171/6	100	19/26	405.00
171/7	100	24/29	435.00



172 Flasks Pear Shaped, "JSGW", Two necks, side neck at angle.

Cat. No.	Capacity ml.	Center Socket	Side Socket	Price/Piece (₹)
172/1	25	14/23	14/23	380.00
172/2	50	14/23	14/23	490.00
172/3	100	14/23	14/23	525.00

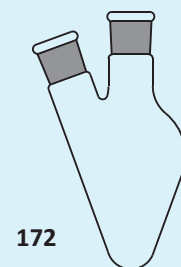

173 Flasks Pear Shaped, "JSGW", Three necks, one side neck at angle, one side neck parallel.

Cat. No.	Capacity ml.	Center Socket	Side Sockets	Price/Piece (₹)
173/1	25	14/23	14/23	575.00
173/2	50	14/23	14/23	615.00
173/3	100	14/23	14/23	655.00

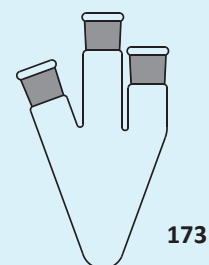

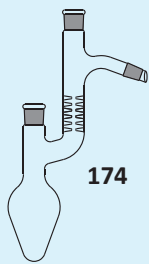

174

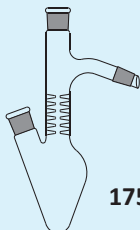

175

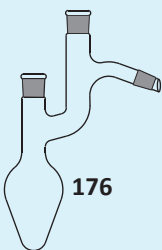

176

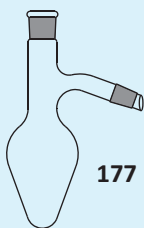

177

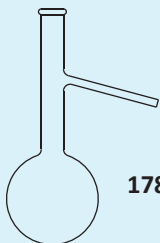

178

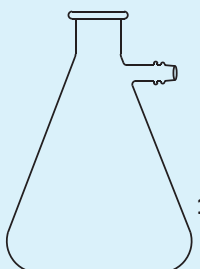

179

174 Flasks Pear shaped, Vigreux, "JSGW", Claisen Type.

Cat. No.	Capacity ml.	Sockets	Cone	Price/Piece (₹)
174/1	10	14/23	14/23	615.00
174/2	25	14/23	14/23	630.00
174/3	50	14/23	14/23	630.00
174/4	100	14/23	14/23	830.00

175 Flasks Pear shaped, Vigreux, "JSGW", with side neck.

Cat. No.	Capacity ml.	Sockets	Cone	Price/Piece (₹)
175/1	10	14/23	14/23	615.00
175/2	25	14/23	14/23	630.00
175/3	50	14/23	14/23	630.00
175/4	100	14/23	14/23	830.00

176 Flasks Claisen, Pear Shaped, "JSGW".

Cat. No.	Capacity ml.	Sockets	Cone	Price/Piece (₹)
176/1	10	14/23	14/23	545.00
176/2	25	14/23	14/23	575.00
176/3	50	14/23	14/23	625.00
176/4	100	14/23	14/23	760.00

177 Flasks Distillation, Pear Shaped, "JSGW".

Cat. No.	Capacity ml.	Sockets	Cone	Price/Piece (₹)
177/1	10	14/23	14/23	320.00
177/2	25	14/23	14/23	380.00
177/3	50	14/23	14/23	490.00
177/4	100	14/23	14/23	560.00

178 Flasks Distillation, "JSGW", with side tube at angle.

Cat. No.	Capacity ml.	Minimum Qty/Pack	Price/Piece (₹)
178/1	25	6	230.00
178/2	50	6	270.00
178/3	100	6	360.00
178/3A	125	6	380.00
178/4	250	6	455.00
178/5	500	6	530.00
178/6	1000	6	810.00

Note : In Cat. No. 178 flasks above 500 ml. will be of short neck.

179 Flasks Filtering, Heavywall, Bolt Neck., with tubulation, "JSGW".

Cat. No.	Capacity ml.	Minimum Qty/Pack	Price/Piece (₹)
179/1	100	12	400.00
179/2	250	12	685.00
179/3	500	12	830.00
179/4	1000	6	1470.00
179/5	2000	4	2595.00
179/6	5000	2	9040.00
179/7	* 10000	1	15910.00
179/8	* 20000	1	25050.00
179/9	50	12	295.00

Note : \* Bottle shape

Note : \* For Cork, please refer Cat no. -1346

180 Flasks Conical, "JSGW", with Screw Cap and liner.

Cat. No.	Capacity ml.	Minimum Qty./Pack	Price/Piece (₹)
180/1	25	12	240.00
180/2	50	12	285.00
180/3	100	12	340.00
180/4	150	12	390.00
180/5	250	12	450.00
180/6	500	12	585.00
180/7	1000	12	1060.00
180/8	2000	6	1845.00
180/8-1	3000	4	2990.00
180/9	5000	2	6590.00

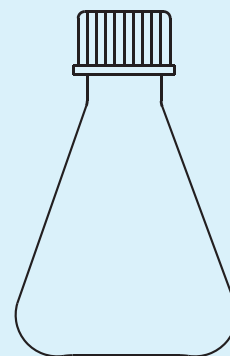

180

181 Flasks Conical, "JSGW", with interchangeable penny head stopper.

Cat. No.	Capacity ml.	Socket size	Minimum Qty./Pack	Price/Pcs (₹)
181/1	25	14/23	12	275.00
181/2	50	19/26	12	315.00
181/3	100	24/29	12	385.00
181/3A	100	19/26	12	385.00
181/3B	100	29/32	12	395.00
181/4	150	24/29	12	430.00
181/5	250	24/29	12	445.00
181/5A	250	29/32	12	445.00
181/6	500	24/29	12	625.00
181/7	1000	24/29	12	895.00
181/8	2000	34/35	6	1925.00

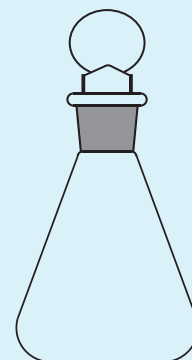

181

181 A Amber Colour Flask Conical "JSGW", with interchangeable penny head stopper.

Cat. No.	Capacity ml.	Socket size	Minimum Qty./Pack	Price/Piece (₹)
181A/1	25	14/23	12	395.00
181A/2	50	19/26	12	415.00
181A/3	100	24/29	12	525.00
181A/3B	100	29/32	12	525.00
181A/4	150	24/29	12	565.00
181A/5	250	24/29	12	655.00
181A/5A	250	29/32	12	655.00
181A/6	500	24/29	12	930.00
181A/7	1000	24/29	12	1705.00
181A/8	2000	34/35	6	2945.00

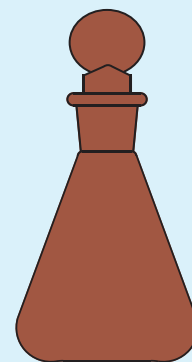

181A

182 Flasks Iodine, "JSGW", with funnel shaped cup and stopper.

Cat. No.	Capacity ml.	Socket size	Minimum Qty./Pack	Price/Pcs (₹)
182/1	100	24/29	12	325.00
182/2	250	24/29	12	405.00
182/3	500	24/29	12	500.00
182/4	1000	24/29	12	1160.00

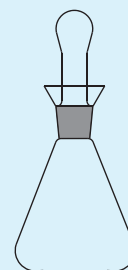

182

**183** Flasks Erlenmeyer's, "JSGW", Conical, Approx. Graduation, Narrow mouth.

Cat. No.	Capacity ml.	Approx. Neck O.D. mm.	Graduation Interval, ml.	Minimum Qty/Pack	Price/Piece (₹)
183/1	5	-	-	24	80.00
183/2	10	15	-	24	90.00
183/3	25	21	-	24	119.00
183/4	50	21	-	24	130.00
183/5	100	25	25	24	130.00
183/5-☒	100	25	25	24	150.00
183/6	150	28	25	24	160.00
183/7	250	34	50	12	195.00
183/7-☒	250	34	50	12	210.00
183/8	500	34	100	12	280.00
183/8-☒	500	34	100	12	295.00
183/9	1000	42	200	12	480.00
183/10	2000	48	500	6	1380.00
183/11	3000	48	500	6	2260.00
183/12	5000	50	500	2	3715.00

*Note :Flasks 5ml to 25 ml capacity are not graduated.*

**183A** Amber Colour Flasks Erlenmeyer's, "JSGW" Conical, Approx. Graduation, Narrow mouth.

Cat. No.	Capacity ml.	Minimum Qty/Pack	Price/Piece (₹)
183A/1	50	12	225.00
183A/2	100	12	255.00
183A/3	250	12	340.00
183A/4	500	12	545.00
183A/5	1000	4	1005.00
183A/6	2000	4	2010.00

**184** Flasks Kjeldhal, "JSGW", Round Bottom, long neck.

Cat. No.	Capacity ml.	Minimum Qty/Pack	Price/Piece (₹)
184/1	10	6	136.00
184/2	30	6	175.00
184/3	50	6	270.00
184/4	100	6	295.00
184/5	300	6	465.00
184/6	500	6	785.00
184/7	800	6	980.00

**185** Flasks Erlenmeyer, "JSGW", Conical, long neck, without rim, Cap. 250ml., O.D. x Ht. 78 x 154mm. approx, Neck dia 25mm. Price/Piece 270.00

**186** Flasks Erlenmeyer, "JSGW", Conical, wide mouth

Cat. No.	Capacity ml.	O.D. x Ht. mm. (approx.)	Neck O.D. mm. (approx.)	Price/Piece (₹)
186/1	100	70x110	34	155.00
186/2	250	85x142	50	215.00
186/3	500	105x175	50	335.00
186/4	1000	120x220	56	570.00

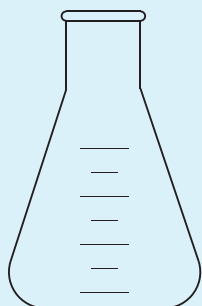

**183**

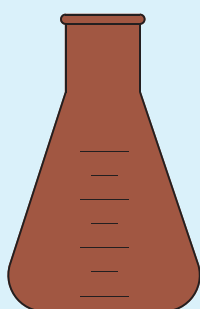

**183A**

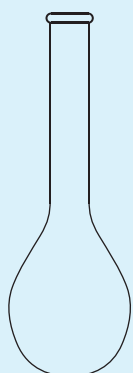

**184**

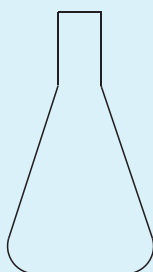

**185**



**186**

187 Flasks Conical, Rimless "JSGW", 750ml, O.D x Ht. 114 x 210 mm Price/Piece approx, Neck O.D. 34mm (₹) 615.00

188 Flasks Boiling, Round Bottom, "JSGW"

Cat. No.	Capacity ml.	Minimum Qty./Pack	Price/Piece (₹)
188/1	100	24	175.00
188/1-☒	100	24	190.00
188/2	150	24	185.00
188/3	250	12	190.00
188/3-☒	250	12	205.00
188/4	500	12	325.00
188/4-☒	500	12	340.00
188/5	1000	12	520.00
188/6	2000	6	1440.00
188/7	3000	6	2415.00
188/8	5000	2	3960.00
188/9	10000	1	8320.00
188/10	20000	1	15340.00
188/11	25	24	130.00
188/12	50	24	155.00

188A Amber Colour Flasks, Boiling, Round Bottom "JSGW".

Cat. No.	Capacity ml.	Minimum Qty./Pack	Price/Piece (₹)
188A/1	50	12	430.00
188A/2	100	12	620.00
188A/3	250	12	620.00
188A/4	500	12	1040.00
188A/5	1000	4	1395.00
188A/6	2000	4	2165.00

189 Flasks Boiling, Flat Bottom, "JSGW"

Cat. No.	Capacity ml.	Minimum Qty./Pack	Price/Piece (₹)
189/1	100	24	175.00
189/1-☒	100	24	190.00
189/2	150	24	185.00
189/3	250	12	190.00
189/3-☒	250	12	205.00
189/4	500	12	325.00
189/4-☒	500	12	340.00
189/5	1000	12	525.00
189/6	2000	12	1440.00
189/7	3000	6	2460.00
189/8	5000	2	4035.00
189/9	10000	1	8640.00
189/10	20000	1	15775.00
189/11	25	24	130.00
189/12	50	24	155.00
189/13	300	12	275.00

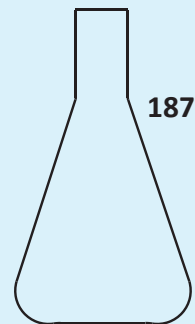

187

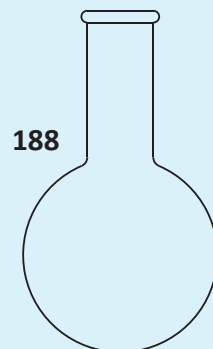

188

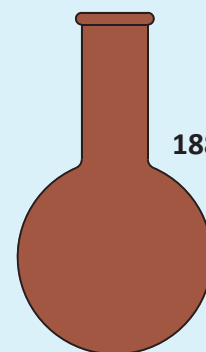

188 A

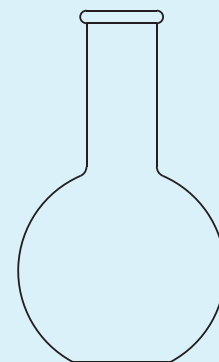

189

**189A Amber Colour Flasks, Boiling, Flat Bottom "JSGW".**

Cat. No.	Capacity ml.	Minimum Qty./Pack	Price/Piece (₹)
189A/1	50	12	430.00
189A/2	100	12	620.00
189A/3	250	12	670.00
189A/4	500	12	1040.00
189A/5	1000	4	1395.00
189A/6	2000	4	2165.00

**190 Flasks Culture, Haffkine "JSGW", as per IS 7183.**

Cat. No.	Capacity ml.	Approx. O.D. Ht. (mm)	Minimum Qty./Pack	Price/Piece (₹)
190/1	3000	245 x 280	2	4125.00
190/2	4000	246 x 310	2	4845.00

**191 Brush, For Flasks, Made of Nylon Bristles.**

10 105.00

**192 Test Tube with side arm, "JSGW", Schlenk Type with socket and stopper.**

Cat. No.	Capacity ml.	Socket Size	Minimum Qty./Pack	Price/Piece (₹)
192/1	10	10/19	10	450.00
192/2	20	14/23	10	4500.00
192/3	25	19/26	10	535.00
192/4	50	19/26	10	580.00
192/5	100	24/29	10	560.00
192/6	150	24/29	10	955.00

**193 Flask Round Bottom with side arm glass key stopcock, "JSGW", Schlenk Type with socket.**

Cat. No.	Capacity ml.	Socket Size	Minimum Qty./Pack	Price/Piece (₹)
193/1	25	10/19	10	520.00
193/2	50	14/23	10	560.00
193/3	100	24/29	10	615.00
193/4	250	24/29	10	695.00
193/5	500	24/29	10	955.00
193/6	1000	24/29	10	1245.00
193/7	2000	24/29	10	3300.00

**194 Reagent Bottle Screw Cap with side arm glass key stopcock, "JSGW", Schlenk Type with blue cap and pouring ring.**

Cat. No.	Capacity ml.	DIN Thread	Minimum Qty./Pack	Price/Piece (₹)
194/1	50	GL 32	2	815.00
194/2	100	GL 45	2	915.00
194/3	250	GL 45	2	940.00
194/4	500	GL 45	2	1035.00
194/5	1000	GL 45	2	1450.00
194/6	2000	GL 45	2	3300.00

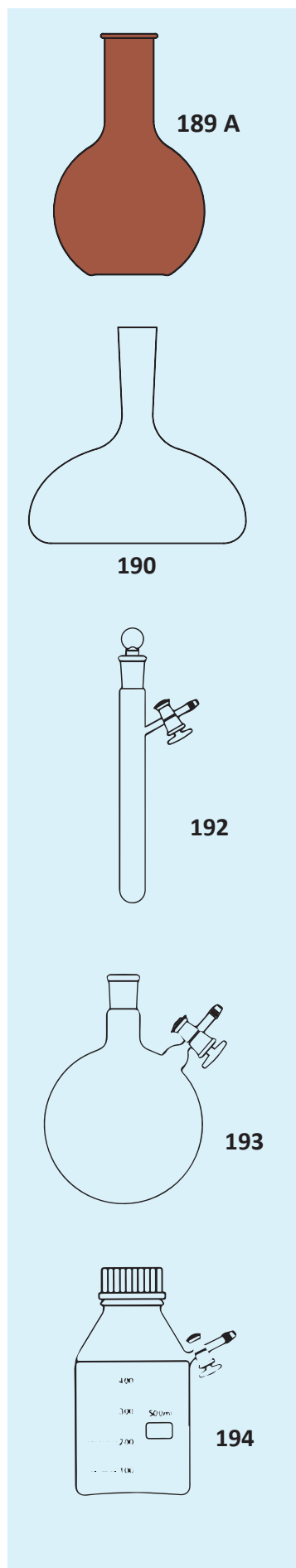

- 196 Vaccum Manifold Double Bank, "JSGW", with high vaccum glass key stopcock.

Cat. No.	No. of Ports	Min. Qty./Pack	Price/Piece (₹)
196/1	3	1	52070.00
196/2	4	1	53460.00
196/3	5	1	57855.00

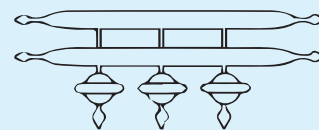

196

- 197 Double Walled Round Bottom Flask with Interchangeable joint, "JSGW".

Cat. No.	Cap. Inner Chamber(ml)	Socket size	Minimum Qty./Pack	Price/Piece (₹)
197/1	1000	24/29	1	29280.00
197/2	2000	24/29	1	32210.00

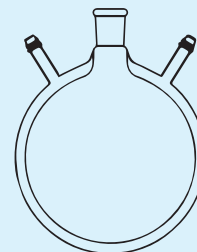

197

## STANDARD JOINTS, STOPPERS, ADAPTERS

- 201 Sockets, "JSGW", Plain Shank, Single.

Cat. No.	Socket	Min. Qty./Pack	Price/Piece (₹)
201/1	7/16	12	124.00
201/2	10/19	12	124.00
201/3	12/21	12	124.00
201/4	14/23	12	124.00
201/5	19/26	12	136.00
201/6	24/29	12	165.00
201/7	29/32	12	205.00
201/8	34/35	12	240.00
201/9	40/38	12	370.00
201/10	45/40	12	440.00
201/11	50/42	12	535.00
201/12	55/44	12	725.00



201

- 202 Cones, "JSGW", Plain End, Single.

Cat. No.	Cone	Min. Qty./Pack	Price/Piece (₹)
202/1	7/16	12	124.00
202/2	10/19	12	124.00
202/3	12/21	12	124.00
202/4	14/23	12	124.00
202/5	19/26	12	136.00
202/6	24/29	12	165.00
202/7	29/32	12	205.00
202/8	34/35	12	240.00
202/9	40/38	12	370.00
202/10	45/40	12	440.00
202/11	50/42	12	535.00
202/12	55/44	12	725.00

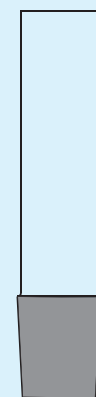

202

*Note : Cones with tip, 10% extra, for hooks 10% extra on cone & socket*

203 Sockets, "JSGW", Double.

Cat. No.	Socket	Shank Length mm. (approx.)	Minimum Qty./Pack	Price/Piece (₹)
203/1	7/16	80	12	220.00
203/2	10/19	80	12	220.00
203/3	14/23	80	12	220.00
203/4	19/26	80	12	230.00
203/5	24/29	80	12	290.00
203/6	29/32	90	12	365.00
203/7	34/35	100	12	425.00
203/8	40/38	110	12	655.00

*Note : Sockets with Hooks, 10% extra.*

204 Cones, "JSGW", Plain End, Double.

Cat. No.	Cone	Shank Length mm. (approx.)	Minimum Qty./Pack	Price/Piece (₹)
204/1	7/16	80	12	220.00
204/2	10/19	80	12	220.00
204/3	14/23	80	12	220.00
204/4	19/26	80	12	230.00
204/5	24/29	80	12	290.00
204/6	29/32	90	12	365.00
204/7	34/35	100	12	425.00
204/8	40/38	110	12	655.00

*Note : Cones with tip, 10% extra, for hooks 10% extra.*

205 Spherical Joints, Ball and Cup,"JSGW".

Cat. No.	Joint Size	Approx. Bore mm.	Price/Pair (₹)	S.S. Clip (₹)
205/1	S 13	2	630.00	470.00
205/2	S 13	5	630.00	470.00
205/3	S 19	9	530.00	440.00
205/4	S 29	15	635.00	485.00
205/5	S 35	21	815.00	580.00
205/6	S 41	32	1905.00	960.00

206 Polypropylene Clamps for Inter changeable Standard Joints "JSGW".

Cat. No.	Cone Size	Minimum Qty./Pack	Price/Piece (₹)
206/1	14/23	10	26.00
206/2	19/26	10	34.00
206/3	24/29	10	46.00
206/4	29/32	10	52.00
206/5	34/35	10	67.00

207 Polypropylene Stoppers, Interchangeable, "JSGW", Hexagonal Head.

Cat. No.	Cone Size	Minimum Qty./Pack	Price/Piece (₹)
207/1	10/19	50	18.00
207/2	14/23	50	25.00
207/3	19/26	50	28.00
207/4	24/29	50	46.00
207/5	29/32	50	60.00
207/6	34/35	50	76.00
207/7	12/21	50	36.00

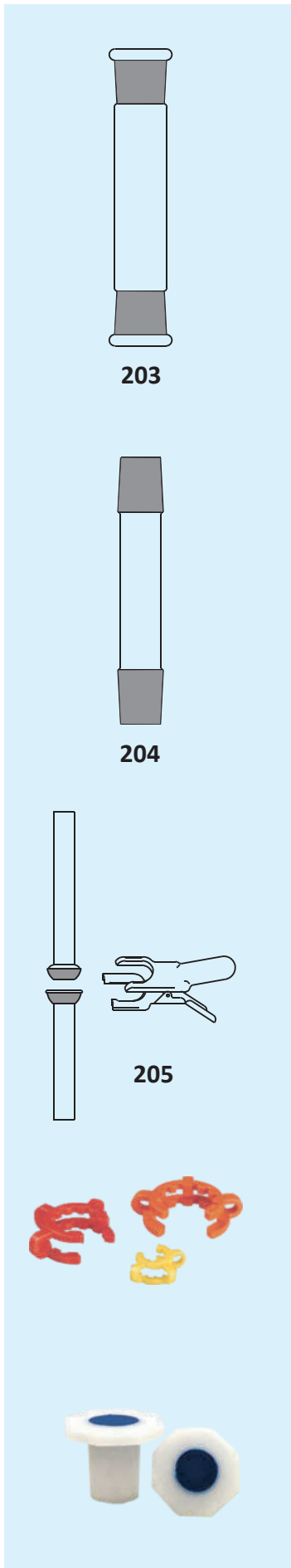

210 Stoppers, Interchangeable, Ground Joint, "JSGW", Hollow, Hexagonal Head.

Cat. No.	Cone Size	Minimum Qty./Pack	Price/Piece (₹)
210/1	10/19	50	50.00
210/2	12/21	50	50.00
210/2A	14/23	50	53.00
210/3	19/26	50	61.00
210/4	24/29	25	79.00
210/5	29/32	25	130.00
210/6	34/35	10	190.00
210/7	40/38	5	435.00
210/8	45/40	5	485.00
210/9	50/42	5	685.00
210/10	55/44	5	775.00

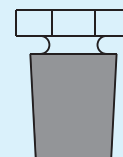

210

210A Amber Colour Hollow Stopper, "JSGW".

Cat. No.	Stopper Size	Minimum Qty./Pack	Price/Piece (₹)
210A/1	10/19	50	75.00
210A/2	14/23	50	77.00
210A/3	19/26	25	90.00
210A/4	24/29	25	105.00
210A/5	34/35	10	210.00

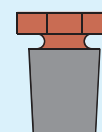

210A

211 Stoppers, Interchangeable, Ground Joint, "JSGW", Solid, Penny Head.

Cat. No.	Cone Size	Minimum Qty./Pack	Price/Piece (₹)
211/1	10/19	50	68.00
211/2	14/23	50	83.00
211/3	19/26	50	119.00
211/4	24/29	25	165.00
211/5	29/32	25	250.00
211/6	34/35	10	360.00



211

211A Stoppers, Interchangeable, Ground Joint, for Reagent Bottle & Volumetric Flask, "JSGW".

Cat. No.	Cone	Capacity ml	Minimum Qty./Pack	Price/Piece (₹)
211A/1	14/23	Regent Bottle, 60 ml	12	78.00
211A/2	19/26	Regent Bottle, 125 & 250 ml	12	105.00
211A/3	24/29	Regent Bottle, 500 ml	12	155.00
211A/4	29/32	Regent Bottle, 1000 ml	12	235.00
211A/5	34/35	Regent Bottle, 2000 ml	12	390.00
211A/6	10/19	Volumetric Flask 5, 10, 20 ml	50	68.00
211A/7	10/19	Volumetric Flask 25 ml	50	68.00
211A/8	14/23	Volumetric Flask 100, 200, 250 ml	50	83.00
211A/9	19/26	Volumetric Flask 500 ml	25	119.00
211A/10	24/29	Volumetric Flask 1000 ml	25	165.00
211A/11	29/32	Volumetric Flask 2000 ml	25	250.00
211A/12	12/21	Volumetric Flask 50 ml	50	75.00

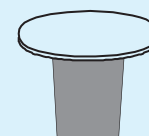

Flat Head  
211A/1 - 211A/5



Volumetric Flask  
211A/6 - 211A/10

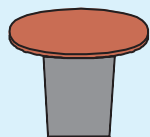

Flat Head  
212/1 - 212/5

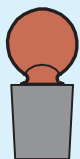

Volumetric Flask  
212/6 - 212/10

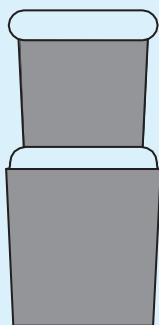

213

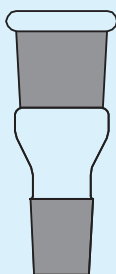

214

212 Amber Colour Stopper I/C, Ground Joint, for Reagent Bottles & Vol. Flasks.

Cat. No.	Cone	Capacity ml	Minimum Qty./Pack	Price/Piece (₹)
212/1	14/23	Reagent Bottle, 60 ml.	12	115.00
212/2	19/26	Reagent Bottle, 125& 250 ml	12	155.00
212/3	24/29	Reagent Bottle, 500 ml	12	225.00
212/4	29/32	Reagent Bottle, 1000 ml	12	355.00
212/5	34/35	Reagent Bottle, 2000 ml	12	550.00
212/6	10/19	Volumetric Flask, 5,10,20 ml	50	90.00
212/7	10/19	Volumetric Flask, 25 ml	50	90.00
212/8	14/23	Volumetric Flask, 100,200,250ml	50	120.00
212/9	19/26	Volumetric Flask, 500 ml	25	155.00
212/10	24/29	Volumetric Flask, 1000 ml	25	190.00
212/11	29/32	Volumetric Flask, 2000 ml	25	305.00
212/12	12/21	Volumetric Flask, 50 ml	50	105.00

213 Reduction Adapters, "JSGW"

Cat. No.	Socket Size	Cone Size	Minimum Qty./Pack	Price/Piece (₹)
213/1	14/23	19/26	12	150.00
213/2	14/23	24/29	12	170.00
213/3	14/23	29/32	12	220.00
213/4	19/26	24/29	12	185.00
213/5	19/26	29/32	12	220.00
213/6	19/26	34/35	12	275.00
213/7	19/26	40/38	12	330.00
213/8	19/26	45/40	12	350.00
213/9	19/26	55/44	12	500.00
213/10	24/29	29/32	12	235.00
213/11	24/29	34/35	12	275.00
213/12	24/29	40/38	12	330.00
213/13	24/29	45/40	12	360.00
213/14	24/29	50/42	12	425.00
213/15	24/29	55/44	12	515.00
213/16	29/32	34/35	12	315.00
213/17	29/32	40/38	12	355.00
213/18	34/35	40/38	12	385.00
213/19	34/35	50/42	12	480.00
213/20	34/35	55/44	12	550.00
213/21	40/38	55/44	12	680.00

214 Expansion Adapters, "JSGW"

Cat. No.	Socket	Cone	Minimum Qty./Pack	Price/Piece (₹)
214/1	19/26	14/23	12	175.00
214/2	24/29	14/23	12	230.00
214/3	24/29	19/26	12	210.00
214/4	29/32	19/26	12	260.00
214/5	29/32	24/29	12	270.00
214/6	34/35	19/26	12	305.00
214/7	34/35	24/29	12	325.00
214/8	34/35	29/32	12	340.00
214/9	40/38	24/29	12	395.00

Note : Reduction & Expansion adapters of any other combination can also be supplied.

216 Multiple Adapters, "JSGW", with Two Necks Parallel.

Cat. No.	Socket Size	Cone Size	Price/Piece (₹)
216/1	14/23	14/23	350.00
216/2	19/26	19/26	395.00
216/3	19/26	24/29	400.00
216/4	24/29	24/29	480.00
216/5	19/26	34/35	535.00
216/6	29/32	29/32	635.00

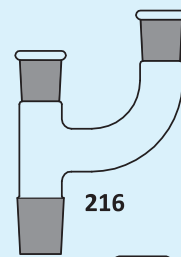

216

217 Multiple Adapters, "JSGW", with Two Necks at 45°.

Cat. No.	Socket Size	Cone Size	Price/Piece (₹)
217/1	19/26	19/26	395.00
217/2	19/26	24/29	400.00
217/3	19/26	34/35	535.00

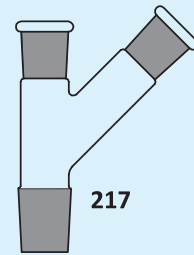

217

218 Multiple Adapters, "JSGW", with Three Necks, Two Parallel and one at 45°.

Cat. No.	Socket Size	Cone Size	Price/Piece (₹)
218/1	19/26	24/29	565.00
218/2	19/26	29/32	655.00
218/3	19/26	34/35	665.00
218/4	19/26	45/40	955.00
218/5	19/26	55/44	1115.00

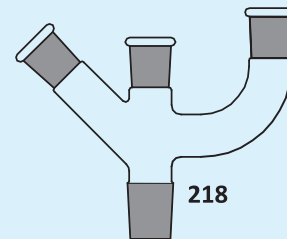

218

219 Swan Neck Adapters, "JSGW".

Cat. No.	Socket Size	Cone Size	Price/Piece (₹)
219/1	19/26	19/26	300.00
219/2	19/26	24/29	300.00
219/3	24/29	24/29	325.00
219/4	24/29	34/35	355.00

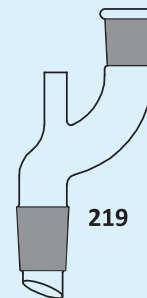

219

220 Receiver Adapters, "JSGW", Plain Bend Short/long.

Cat. No.	Socket Size	Price/Piece (₹)
220/1	14/23	165.00
220/2	19/26	190.00
220/3	24/29	220.00
220/4	29/32	260.00
220/5	34/35	325.00
220/6	40/38	435.00
220/7	45/40	560.00
220/8	50/42	690.00
220/9	55/44	725.00

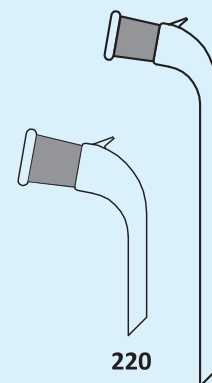

220

220

221 Straight Delivery Adapters, "JSGW".

Cat. No.	Socket Size	Price/Piece (₹)
221/1	14/23	165.00
221/2	19/26	190.00
221/3	24/29	220.00
221/4	29/32	260.00
221/5	34/35	325.00

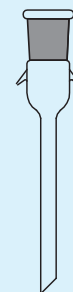

221

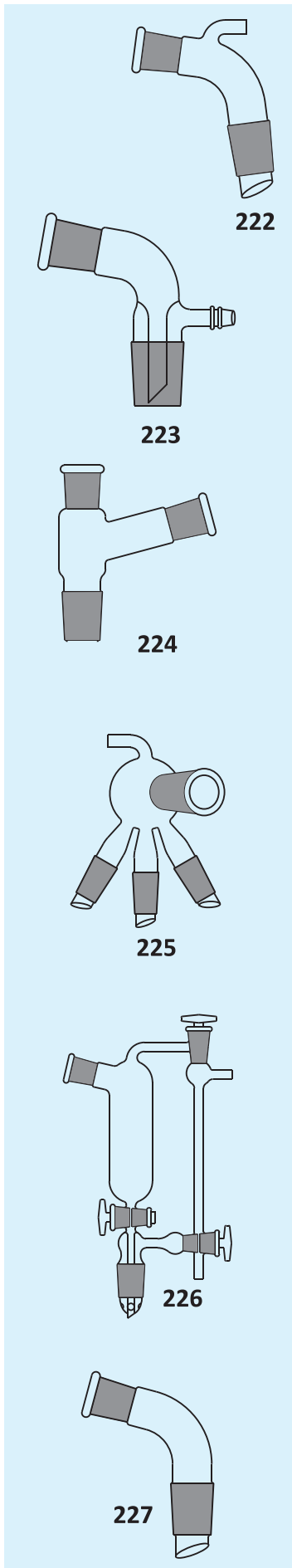

**222 Receiver Adapters, "JSGW", Bend with Vent.**

Cat. No.	Socket Size	Cone Size	Price/Piece (₹)
222/1	14/23	14/23	315.00
222/2	19/26	19/26	350.00
222/3	19/26	24/29	360.00
222/4	24/29	24/29	435.00
222/5	34/35	34/35	630.00

**223 Receiver Adapters, "JSGW", Bend or Straight with Vacuum connection.**

Cat. No.	Socket Size	Cone Size	Price/Piece (₹)
223/1	14/23	14/23	325.00
223/2	19/26	19/26	350.00
223/3	19/26	24/29	355.00
223/4	24/29	24/29	415.00
223/5	24/29	34/35	500.00
223/6	34/35	34/35	590.00
223/7	29/32	29/32	470.00

**224 Receiver Adapters, "JSGW", Bend with Socket Connections.**

Cat. No.	Socket Size	Cone Size	Price/Piece (₹)
224/1	14/23	14/23	350.00
224/2	19/26	19/26	395.00
224/3	19/26	24/29	400.00

**225 Receiver Adapters, "JSGW", Bend with Multiple Connections (Pig).**

Cat. No.	Socket Size	Cone Size	Price/Piece (₹)
225/1	14/23	14/23	660.00
225/2	14/23	19/26	690.00
225/3	19/26	19/26	715.00

**226 Perkin Intermediate Receiver, "JSGW".**

Cat. No.	Socket Size	Cone Size	Price/Piece (₹)
226/1	14/23	14/23	2120.00
226/2	19/26	19/26	2185.00
226/3	19/26	24/29	2195.00
226/4	24/29	24/29	2265.00
226/5	34/35	24/29	2565.00
226/6	34/35	34/35	3125.00

**227 Receiver Adapters, Plain Bend, "JSGW".**

Cat. No.	Socket Size	Cone Size	Price/Piece (₹)
227/1	19/26	19/26	290.00
227/2	19/26	24/29	305.00
227/3	24/29	24/29	360.00
227/4	34/35	34/35	560.00

## STILL HEADS / SPLASH HEADS

### 231 Still Heads, Recovery Bend, "JSGW", Sloping (Elbow).

Cat. No.	Cone fitting flask	Cone Fitting Condenser	Price/Piece (₹)
231/1	14/23	14/23	255.00
231/2	24/29	14/23	330.00
231/3	19/26	19/26	285.00
231/4	24/29	19/26	340.00
231/5	29/32	19/26	380.00
231/6	34/35	19/26	450.00
231/7	24/29	24/29	330.00
231/8	34/35	24/29	425.00
231/9	55/44	24/29	855.00
231/10	34/35	34/35	560.00
231/11	29/32	29/32	445.00

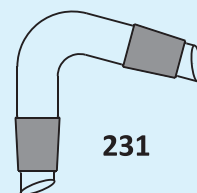

### 232 Still Heads, Recovery Bend, "JSGW", Vertical.

Cat. No.	Cone fitting flask	Cone Fitting Condenser	Price/Piece (₹)
232/1	14/23	14/23	300.00
232/2	19/26	19/26	355.00
232/3	24/29	14/23	420.00
232/4	24/29	24/29	470.00
232/5	34/35	34/35	695.00

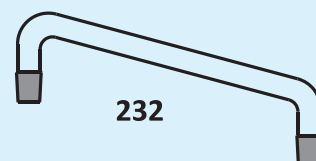

### 233 Recovery Head, "JSGW", Sloping with 14/23 Socket.

Cat. No.	Cone fitting flask	Cone Fitting Condenser	Price/Piece (₹)
233/1	14/23	14/23	355.00
233/2	19/26	19/26	420.00
233/3	24/29	19/26	435.00
233/4	29/32	19/26	465.00
233/5	34/35	19/26	520.00
233/6	24/29	24/29	445.00
233/7	34/35	24/29	695.00
233/8	55/44	24/29	910.00
233/9	34/35	34/35	730.00
233/10	55/44	34/35	975.00
233/11	29/32	29/32	535.00

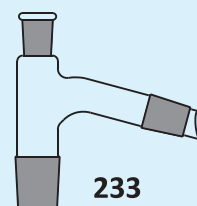

### 234 Claisen Heads, "JSGW", Sloping with 2x 14/23 Sockets.

Cat. No.	Cone fitting flask	Cone Fitting Condenser	Price/Piece (₹)
234/1	14/23	14/23	500.00
234/2	19/26	19/26	560.00
234/3	24/29	19/26	595.00
234/4	34/35	19/26	710.00
234/5	24/29	24/29	660.00
234/6	34/35	24/29	725.00

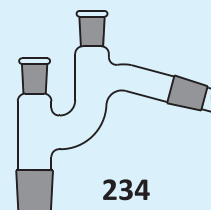

### 235 Splash Heads, "JSGW", Pear Shape, Sloping.

Cat. No.	Cone fitting flask	Cone Fitting Condenser	Price/Piece (₹)
235/1	19/26	19/26	545.00
235/2	24/29	19/26	565.00
235/3	34/35	19/26	715.00
235/4	34/35	24/29	725.00
235/5	34/35	34/35	790.00
235/6	24/29	24/29	590.00

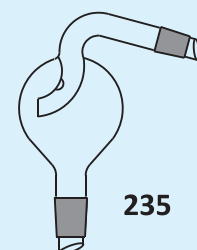

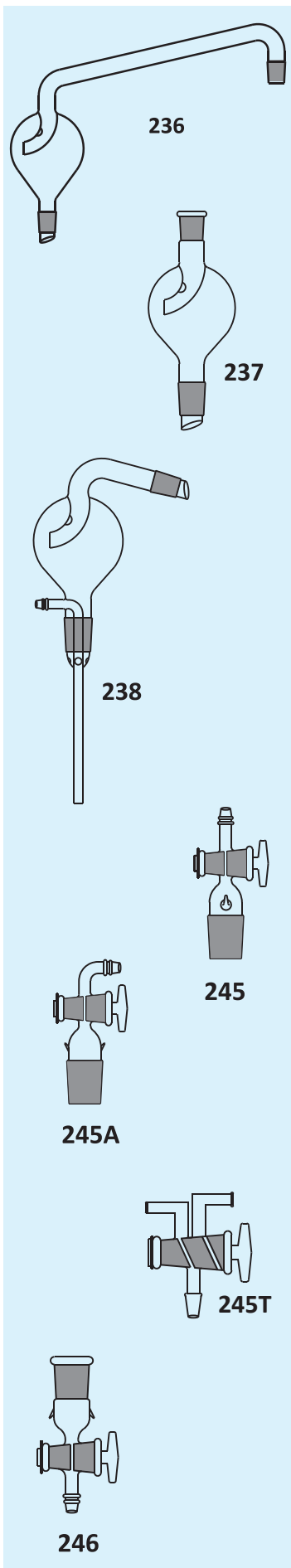

**236** Splash Heads, "JSGW", Pear Shape, Vertical

Cat. No.	Cone fitting flask	Cone Fitting Condenser	Price/Piece (₹)
236/1	19/26	19/26	620.00
236/2	24/29	19/26	635.00
236/3	34/35	19/26	800.00
236/4	24/29	24/29	665.00
236/5	34/35	24/29	860.00

**237** Splash Head Adapter, "JSGW".

Cat. No.	Cone fitting flask	Cone Fitting Condenser	Price/Piece (₹)
237/1	24/29	19/26	780.00

**238** Steam Distillation Heads "JSGW" Pear Shape, Sloping.

Cat. No.	Cone fitting flask	Cone Fitting Condenser	Price/Piece (₹)
238/1	24/29	19/26	690.00
238/2	34/35	19/26	715.00
238/3	34/35	24/29	730.00

## MISCELLANEOUS FITTING

**245** Adapters with Stopcock, "JSGW", Cone to Rubber Tubing, Straight connection.

Cat. No.	Cone size	Price/Piece (₹)
245/1	14/23	405.00
245/2	19/26	425.00
245/3	24/29	440.00
245/4	29/32	525.00
245/5	34/35	590.00

**245A** Adapter with Stopcock, "JSGW", Cone to Rubber Tubing, Right Angle Connection.

Cat. No.	Cone size	Price/Piece (₹)
245A/1	14/23	405.00
245A/2	19/26	425.00
245A/3	24/29	440.00
245A/4	29/32	525.00
245A/5	34/35	590.00

**245T** Adapter, with Three Way Oblique Bore Stopper, Cone with Straight, at Right Angle Connection.

Cat. No.	Cone size	Minimum Qty/Pack	Price/Piece (₹)
245T/1	14/23	5	925.00
245T/2	19/26	5	975.00
245T/3	24/29	5	1020.00
245T/4	29/32	5	1090.00
245T/5	34/35	5	1215.00

**246** Adapters, "JSGW", Socket to Rubber Tubing, Straight or Right angle connection, with Stopcock.

Cat. No.	Socket size	Price/Piece (₹)
246/1	14/23	435.00
246/2	19/26	440.00
246/3	24/29	455.00
246/4	29/32	545.00

247 Adapters, "JSGW", Cone to rubber tubing, straight connection.

Cat. No.	Socket size	Price/Piece (₹)
247/1	14/23	160.00
247/2	19/26	175.00
247/3	24/29	195.00
247/3A	29/32	230.00
247/4	34/35	280.00



247

247A Adapters, "JSGW", Cone to rubber tubing, Right Angle Connection.

Cat. No.	Cone Size	Price/Piece (₹)
247A/1	14/23	160.00
247A/2	19/26	175.00
247A/3	24/29	195.00
247A/3A	29/32	230.00
247A/4	34/35	280.00

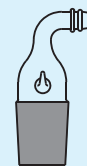

247A

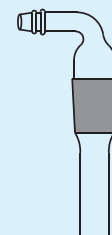

248

248 Adapters, "JSGW", Cone with stem, rubber tubing Right angle connection.

Cat. No.	Cone Size	Price/Piece (₹)
248/1	14/23	205.00
248/2	19/26	225.00
248/3	24/29	250.00



249

249 Adapter, "JSGW", Socket to Rubber tubing, Straight connection.

Cat. No.	Socket Size	Price/Piece (₹)
249/1	19/26	175.00
249/2	24/29	190.00

250 Adapters "JSGW" Socket to cone with Tee Connection.

Cat. No.	Socket Size	Cone Size	Price/Piece (₹)
250/1	14/23	14/23	200.00
250/2	14/23	19/26	210.00
250/3	14/23	24/29	225.00
250/4	19/26	19/26	230.00
250/5	19/26	24/29	255.00
250/6	19/26	34/35	315.00
250/7	24/29	24/29	290.00
250/8	24/29	34/35	355.00
250/9	34/35	34/35	395.00

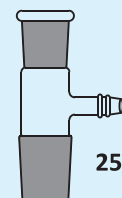

250

252 U Tube, "JSGW", with two sockets or cones.

Cat. No.	Cone	Price/Piece (₹)
252/1	14/23	405.00
252/2	19/26	470.00

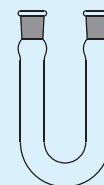

252

253 Drying Tube, "JSGW".

Cat. No.	Cone	Price/Piece (₹)
253/1	14/23	190.00
253/2	19/26	225.00
253/3	24/29	255.00

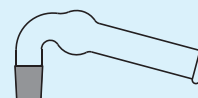

253

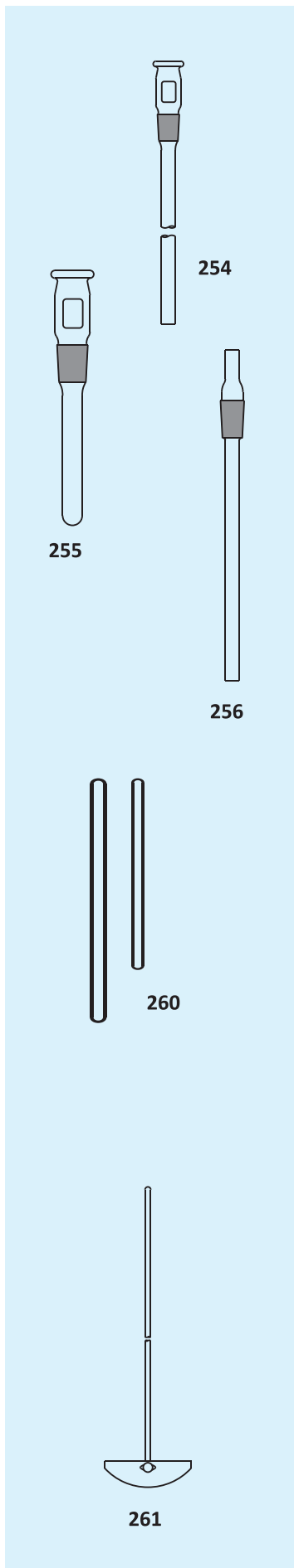

254 Thermometer Pocket, "JSGW", Long type, for sealing to required length.

Cat. No.	Cone	Price/Piece (₹)
254/1	14/23	190.00
254/2	19/26	220.00
254/3	24/29	255.00
254/4	34/35	370.00

Note: Kindly mention the capacity of the flask in Thermometer are to be used.

255 Thermometer Pocket, "JSGW".

Cat. No.	Cone Size	Price/Piece (₹)
255/1	14/23	175.00
255/2	19/26	200.00
255/3	24/29	230.00

256 Air Leak Tube/Gas Inlet Tube, "JSGW".

Cat. No.	Cone Size	Price/Piece (₹)
256/1	14/23	190.00
256/2	19/26	220.00
256/3	24/29	255.00
256/4	34/35	370.00

## STIRRERS

260 Glass Stirring Rods "JSGW".

Cat. No.	Approx OD x Length mm	Minimum Qty/pack	Price/Piece (₹)
260/1	7 x 150	10	32.00
260/2	7 x 205	10	45.00
260/3	7 x 255	10	50.00
260/4	7 x 305	10	60.00
260/5	9 x 150	10	50.00
260/6	9 x 205	10	60.00
260/7	9 x 255	10	77.00
260/8	9 x 305	10	77.00
260/9	9 x 400	10	112.00

261 Teflon Bladed Stirrers, "JSGW", Blade removable from the Stirrer Shaft.

Cat. No.	Approx. shaft dia mm.	Shaft length mm.	Smallest Socket through which blade will pass	Blade width mm.	Price/Piece (₹)
261/1	6	450	19/26	52	465.00
261/2	6	450	24/29	76	560.00
261/3	8	450	24/29	76	595.00
261/4	8	450	29/32	100	760.00
261/5	8	600	34/35	100	760.00
261/6	10	450	34/35	100	830.00
261/7	10	600	34/35	125	1110.00

Shaft for Teflon Bladed stirrers, "JSGW"

261/9	6	450	205.00
261/10	8	450	230.00
261/11	8	600	270.00
261/12	10	450	275.00
261/13	10	600	355.00

262 Link Stirrers, "JSGW".

Cat. No.	Approx. shaft dia mm.	Shaft length mm.	Smallest Socket through which blade will pass	Blade width mm.	Price/Piece (₹)
262/1	6	450	24/29	75	350.00
262/2	6	600	24/29	75	370.00

263 Collapsible Paddle Stirrers, "JSGW".

Cat. No.	Approx. shaft dia mm.	Shaft length mm.	Smallest Socket through which blade will pass	Blade width mm.	Price/Piece (₹)
263	6	600	24/29	75	500.00

264 Fixed Paddle Stirrers, "JSGW".

Cat. No.	Approx. shaft dia mm.	Shaft length mm.	Smallest Socket through which blade will pass	Blade width mm.	Price/Piece (₹)
264/1	6	600	55/44	50	430.00
264/2	8	600	55/44	50	490.00
264/3	10	750	100 mm	80	685.00

268 Stirrers Guides, "JSGW".

Cat. No.	To fit stirrer shaft	Socket Size	Cone Size	Approx. stem length	Price/Piece (₹)
268/1	6 mm	19/26	19/26	200 mm	480.00
268/2	10 mm	24/29	24/29	300 mm	490.00

269 Mercury Seal Glands and Guide, "JSGW".

Cat No.	To Fit stirrer shaft	Cone	Approx. stem length	Price/Piece (₹)
269/1	6 mm	19/26	200 mm	555.00
269/2	6 mm	24/29	200 mm	570.00
269/3	8 mm	34/35	200 mm	700.00

270 Mercury Seal Glands and Cap, "JSGW".

Cat. No.	To Fit stirrer shaft	Cone	Price/Piece (₹)
270/1	6 mm	19/26	550.00
270/2	6 mm	24/29	555.00
270/3	8 mm	34/35	600.00
270/4	6 or 8 mm	24/29 with Teflon tube	1305.00
270/5	6 or 8 mm	34/35 with Teflon tube	1390.00

271 Stuffing Box Glands, "JSGW", with brass pulley fitted with ball bearing.

Cat No.	Material of Cone	To fit stirrer shaft	Cone	Price/Piece (₹)
271/1	PTFE	6 mm	19/26	4045.00
271/2	PTFE	6-8 mm	24/29	4240.00
271/3	PTFE	8 mm	34/35	5200.00
271/4	PTFE	8-10 mm	29/32	4945.00

272 Simple Glands with Cap, "JSGW".

Cat. No.	To Fit stirrer shaft	Cone	Price/Piece (₹)
272/1	6 mm	14/23	460.00
272/2	6 mm	19/26	175.00
272/3	6 mm	24/29	190.00

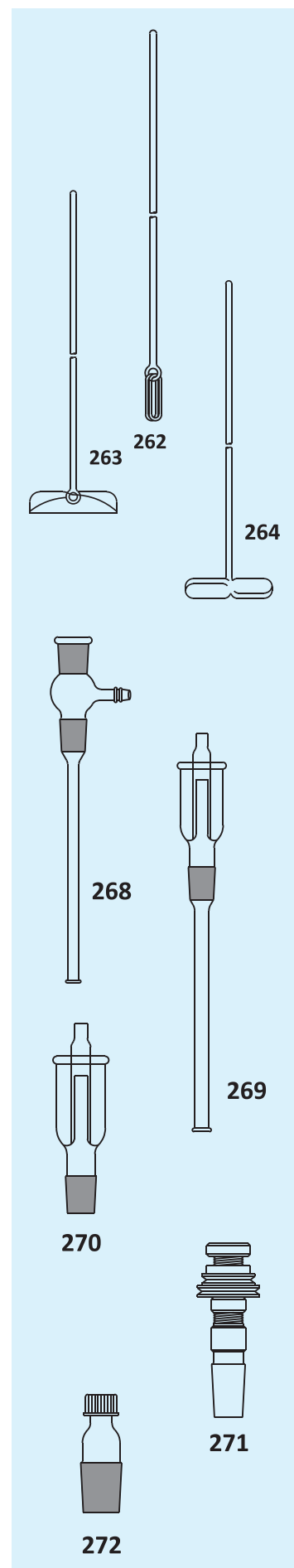

## SEPARATING / DROPPING FUNNELS



280



280A

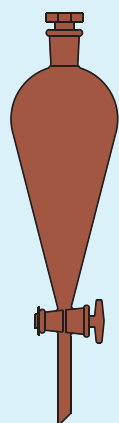

280B

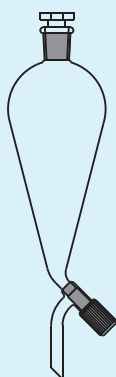

281

280 Separating Funnels, "JSGW", with glass key Stopcock, Interchangeable Stopper, Conical/Pear Shape, Plain Stem.

Cat. No.	Capacity ml.	Minimum Qty./pack	Price/Piece (₹)
280/1	30	4	545.00
280/2	60	4	610.00
280/3	125	4	880.00
280/4	250	4	995.00
280/5	500	4	1290.00
280/6	1000	4	1965.00
280/7	2000	2	4615.00
280/9	5000	1	11180.00

280A Separating Funnels, "JSGW", with Screw thread, O-Ring glass key Stopcock, Interchangeable Stopper, Conical/Pear Shape, Plain Stem.

Cat. No.	Capacity ml.	Minimum Qty./pack	Price/Piece (₹)
280A/1	30	4	830.00
280A/2	60	4	860.00
280A/3	125	4	1145.00
280A/4	250	4	1270.00
280A/5	500	4	1565.00
280A/6	1000	4	2025.00
280A/7	2000	2	4660.00

280B Amber Colour Separating Funnels, "JSGW", with glass key Stopcock, Interchangeable Stopper, Conical/Pear Shape, Plain Stem.

Cat. No.	Capacity ml.	Minimum Qty./pack	Price/Piece (₹)
280B/1	30	4	955.00
280B/2	60	4	1050.00
280B/3	125	4	1250.00
280B/4	250	4	1510.00
280B/5	500	4	1970.00
280B/6	1000	4	2910.00
280B/7	2000	2	6020.00

281 Separating Funnels, "JSGW", with Screw type, PTFE Needle Valve Rotaflow stopcock, Interchangeable Stopper, Conical/Pear Shape, Plain Stem.

Cat. No.	Capacity ml.	Minimum Qty./pack	Price/Piece (₹)
281/1	30	4	530.00
281/2	60	4	625.00
281/3	125	4	895.00
281/4	250	4	1010.00
281/5	500	4	1355.00
281/6	1000	4	1980.00
281/7	2000	2	4620.00

282 Separating Funnels, "JSGW", with PTFE key Stopcock, Interchangeable Stopper, Conical/Pear Shape, Plain Stem.

Cat. No.	Capacity ml.	Minimum Qty./pack	Price/Piece (₹)
282/1	30	4	1025.00
282/2	60	4	1050.00
282/3	125	4	1300.00
282/4	250	4	1470.00
282/5	500	4	2010.00
282/6	1000	4	2685.00
282/7	2000	2	5305.00
282/9	5000	1	12190.00

282A Amber Colour Separating Funnels, "JSGW", with PTFE key Stopcock, Interchangeable Stopper, Conical/Pear Shape, Plain Stem.

Cat. No.	Capacity ml.	Minimum Qty./pack	Price/Piece (₹)
282A/1	30	4	1630.00
282A/2	60	4	1755.00
282A/3	125	4	2015.00
282A/4	250	4	2435.00
282A/5	500	4	3285.00
282A/6	1000	4	4605.00
282A/7	2000	2	9300.00

283 Separating Funnels, "JSGW", with Glass Key Stopcock, Interchangeable Stopper, Globe Shape, Plain Stem.

Cat. No.	Capacity ml.	Minimum Qty./pack	Price/Piece (₹)
283/1	25	2	525.00
283/2	50	2	595.00
283/3	100	2	675.00
283/4	250	2	785.00
283/5	500	2	975.00
283/6	1000	2	1595.00
283/7	2000	2	3300.00
283/8	3000	1	5410.00
283/9	5000	1	7610.00
283/10	10000	1	13275.00
283/11	20000	1	25340.00

284 Separating Funnels, "JSGW", with Screw type PTFE Needle Valve Stopcock, Interchangeable Stopper, Globe Shape, Plain Stem.

Cat. No.	Capacity ml.	Minimum Qty./pack	Price/Piece (₹)
284/1	25	2	500.00
284/2	50	2	555.00
284/3	100	2	645.00
284/4	250	2	860.00
284/5	500	2	1025.00
284/6	1000	2	1670.00
284/7	2000	2	3370.00



282



282A

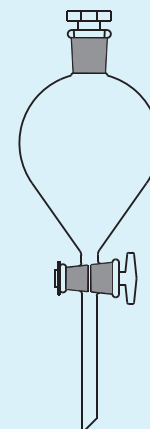

283

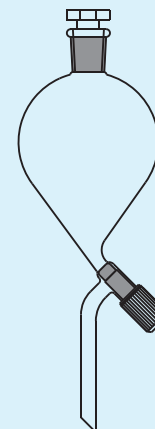

284

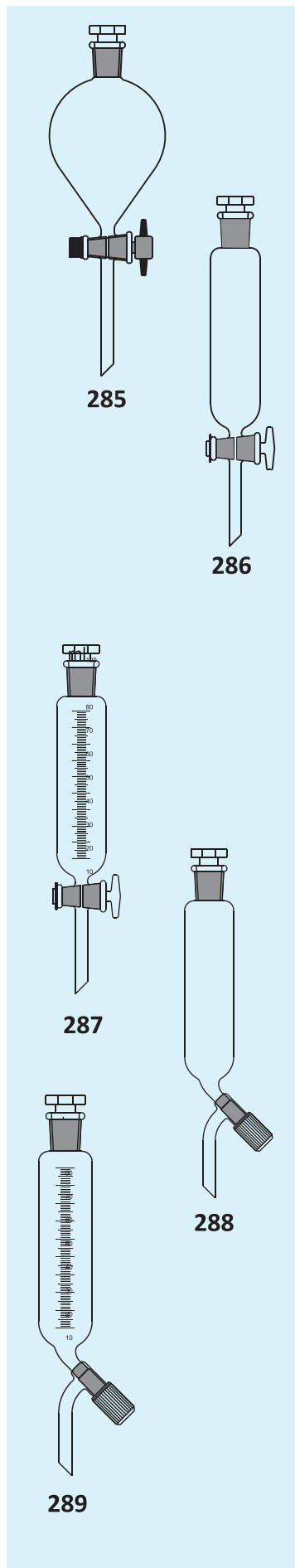

285 Separating Funnels, "JSGW", with PTFE key Stopcock, Interchangeable Stopper, Globe Shape, Plain Stem.

Cat. No.	Capacity ml.	Minimum Qty./pack	Price/Piece (₹)
285/1	25	2	975.00
285/2	50	2	1025.00
285/3	100	2	1120.00
285/4	250	2	1430.00
285/5	500	2	1760.00
285/6	1000	2	2430.00
285/7	2000	2	4140.00

286 Dropping Funnels, "JSGW", Cylindrical, with Interchangeable Stopper and Glass Key Stopcock, Plain Stem.

Cat. No.	Capacity ml.	Socket Size	Price/Piece (₹)
286/1	50	14/23	555.00
286/2	100	19/26	620.00
286/3	150	24/29	660.00
286/4	250	24/29	775.00
286/5	500	24/29	1055.00
286/6	1000	34/35	1890.00

287 Dropping Funnels, "JSGW", Cylindrical, Graduated, with Interchangeable Stopper and Glass Key Stopcock, Plain Stem.

Cat. No.	Capacity ml.	Socket Size	Price/Piece (₹)
287/1	50	14/23	685.00
287/2	100	19/26	790.00
287/3	150	24/29	1040.00
287/4	250	24/29	1120.00
287/5	500	24/29	1430.00
287/6	1000	34/35	2530.00

288 Dropping Funnels, "JSGW", Cylindrical, with Screw type PTFE Needle Valve Stopcock and Interchangeable Stopper, Plain Stem.

Cat. No.	Capacity ml.	Socket Size	Price/Piece (₹)
288/1	50	14/23	495.00
288/2	100	19/26	555.00
288/3	150	24/29	695.00
288/4	250	24/29	885.00
288/5	500	24/29	1280.00
288/6	1000	34/35	2195.00

289 Dropping Funnels, "JSGW", Cylindrical, Graduated, with Screw type PTFE Needle Valve Stopcock and Interchangeable Stopper, Plain Stem.

Cat. No.	Capacity ml.	Socket Size	Price/Piece (₹)
289/1	50	14/23	620.00
289/2	100	19/26	720.00
289/3	150	24/29	980.00
289/4	250	24/29	1110.00
289/5	500	24/29	1670.00
289/6	1000	34/35	2790.00

290 Dropping Funnels, "JSGW", Cylindrical, with Open top Glass Key Stopcock, Stem with Cone.

Cat. No.	Capacity ml.	Cone Size	Price/Piece (₹)
290/1	50	19/26	555.00
290/2	100	19/26	575.00
290/3	100	24/29	600.00
290/4	250	19/26	760.00
290/5	500	24/29	955.00

291 Dropping Funnels, "JSGW", Cylindrical, open top, with Screw type PTFE Needle Valve Stopcock, Stem with Cone.

Cat. No.	Capacity ml.	Cone Size	Price/Piece (₹)
291/1	50	19/26	495.00
291/2	100	19/26	575.00
291/3	100	24/29	590.00
291/4	250	19/26	820.00
291/5	500	24/29	975.00

292 Separating Funnels, "JSGW", pear shape, with socket, Glass Key stopcock and stem with cone but without stopper.

Cat. No.	Capacity ml.	Socket Size	Cone Size	Price/Piece (₹)
292/1	25	14/23	14/23	660.00
292/2	50	14/23	14/23	710.00
292/3	50	19/26	19/26	765.00
292/4	100	14/23	14/23	820.00
292/5	100	19/26	19/26	840.00
292/6	250	14/23	14/23	905.00
292/7	250	19/26	19/26	920.00
292/8	500	19/26	19/26	1145.00
292/9	500	24/29	24/29	1170.00
292/10	1000	19/26	19/26	1750.00
292/11	1000	24/29	24/29	1775.00

293 Separating Funnels, "JSGW", Pear shape, with socket, screw type PTFE Needle Valve Stopcock and stem with cone but without stopper.

Cat. No.	Capacity ml.	Socket Size	Cone Size	Price/Piece (₹)
293/1	25	14/23	14/23	645.00
293/2	50	14/23	14/23	700.00
293/3	50	19/26	19/26	720.00
293/4	100	14/23	14/23	780.00
293/5	100	19/26	19/26	795.00
293/6	250	14/23	14/23	970.00
293/7	250	19/26	19/26	990.00
293/8	500	19/26	19/26	1185.00
293/9	500	24/29	24/29	1200.00
293/10	1000	19/26	19/26	1815.00
293/11	1000	24/29	24/29	1860.00

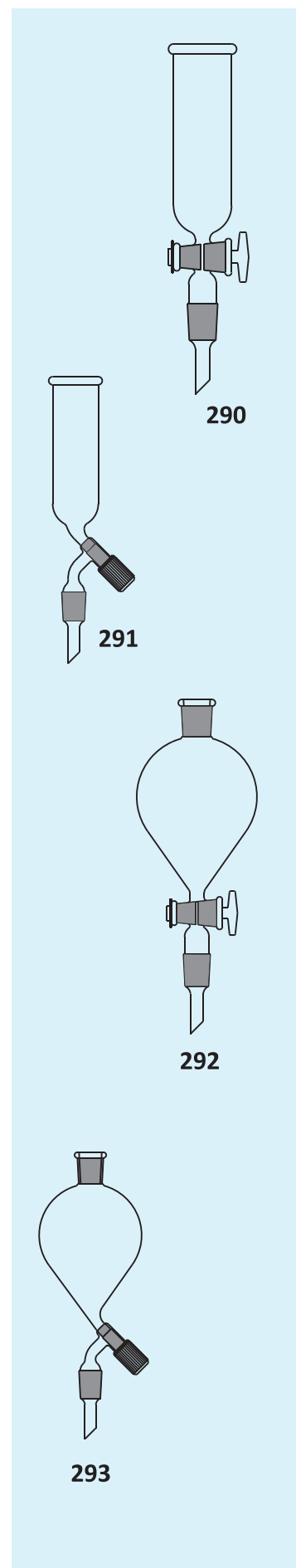

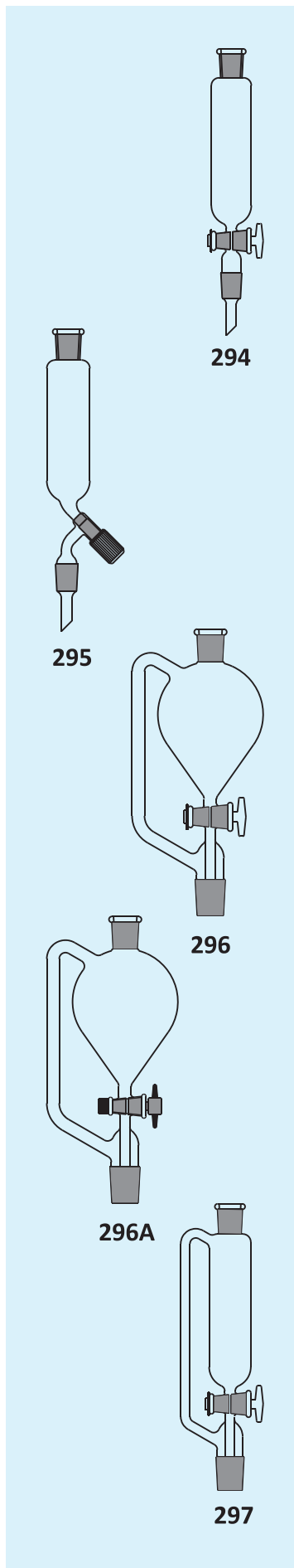

294 **Dropping Funnels, "JSGW"**, Cylindrical, with socket, Glass Key stopcock and stem with cone but without stopper.

Cat. No.	Capacity ml.	Socket Size	Cone Size	Price/Piece (₹)
294/1	25	14/23	14/23	630.00
294/2	50	14/23	14/23	660.00
294/3	100	14/23	14/23	725.00
294/4	100	19/26	19/26	740.00
294/5	250	19/26	19/26	890.00
294/6	500	19/26	19/26	1305.00
294/7	1000	19/26	19/26	1995.00

295 **Dropping Funnels, "JSGW"**, Cylindrical, with socket, Screw type PTFE Needle Valve Stopcock and stem with cone but without stopper.

Cat. No.	Capacity ml.	Socket Size	Cone Size	Price/Piece (₹)
295/1	25	14/23	14/23	555.00
295/2	50	14/23	14/23	615.00
295/3	100	14/23	14/23	720.00
295/4	100	19/26	19/26	740.00
295/5	250	19/26	19/26	1110.00
295/6	500	19/26	19/26	1565.00
295/7	1000	19/26	19/26	2350.00

296 **Pressure Equalising Funnels, "JSGW"**, Pear shape, with socket, Glasskey stopcock and stem with cone.

Cat. No.	Capacity ml.	Socket Size	Cone Size	Price/Piece (₹)
296/1	100	19/26	19/26	1300.00
296/2	100	24/29	24/29	1345.00
296/3	250	19/26	19/26	1385.00
296/4	250	24/29	24/29	1450.00
296/5	500	19/26	19/26	1765.00
296/6	500	24/29	24/29	1815.00
296/7	500	34/35	34/35	2030.00

296A **Pressure Equalising Funnels, "JSGW"**, Pear shape, with socket, PTFE Key stopcock and stem with cone.

Cat. No.	Capacity ml.	Socket Size	Cone Size	Price/Piece (₹)
296A/1	100	19/26	19/26	1745.00
296A/2	100	24/29	24/29	1805.00
296A/3	250	19/26	19/26	1845.00
296A/4	250	24/29	24/29	1900.00
296A/5	500	19/26	19/26	2240.00
296A/6	500	24/29	24/29	2320.00
296A/7	500	34/35	34/35	2700.00

297 **Pressure Equalising Funnels, "JSGW"**, Cylindrical, with socket, Glass Key stopcock and stem with cone.

Cat. No.	Capacity ml.	Socket Size	Cone Size	Price/Piece (₹)
297/1	250	19/26	19/26	1285.00
297/2	250	24/29	24/29	1320.00
297/3	500	19/26	19/26	1725.00
297/4	500	24/29	24/29	1780.00
297/5	50	19/26	19/26	1055.00
297/6	100	19/26	19/26	1125.00

297A Pressure Equalising Funnels, "JSGW", Cylindrical, with socket, PTFE Key stopcock and stem with cone.

Cat. No.	Capacity ml.	Socket	Cone	Price/Piece (₹)
297A/1	250	19/26	19/26	1805.00
297A/2	250	24/29	24/29	1815.00
297A/3	500	19/26	19/26	2445.00
297A/4	500	24/29	24/29	2460.00
297A/5	50	19/26	19/26	1510.00
297A/6	100	19/26	19/26	1650.00

297B Pressure Equalising Funnels, "JSGW", Cylindrical, Graduated with socket, PTFE Key stopcock and stem with cone.

Cat. No.	Capacity ml.	Socket	Cone	Price/Piece (₹)
297B/1	250	19/26	19/26	2220.00
297B/2	250	24/29	24/29	2235.00
297B/3	500	19/26	19/26	2745.00
297B/4	500	24/29	24/29	2840.00
297B/5	50	19/26	19/26	1930.00
297B/6	100	19/26	19/26	2030.00

298 Dropping Funnels, "JSGW", Cylindrical, open top, with Gas outlet tube, Stem with 24/29 Cone, Capacity 100 ml. 845.00

299 Plug Type Funnels, "JSGW", Capacity 50 ml., Socket 10/19, Cone 19/26 645.00

300 Separating Funnel Stand : Rectangular Cast Iron Painted Base with mild steel Chrome Plated or powdered coated rod and retort ring with fixed boss head.

Cat. No.	Funnel Capacity	Base	Rod	Retort Ring Dia	Price/Piece (₹)
300/1	60 ml	6" x 4"	18" x 3/8"	2.5"	895.00
300/2	125 ml	6" x 4"	18" x 3/8"	2.5"	895.00
300/3	250 ml	8" x 5"	24" x 1/2"	3"	1230.00
300/4	500 ml	9" x 6"	30" x 1/2"	3"	1230.00
300/5	1000 ml	9" x 6"	30" x 1/2"	4"	1735.00
300/6	2000 ml	10" x 8"	30" x 1/2"	6"	2935.00

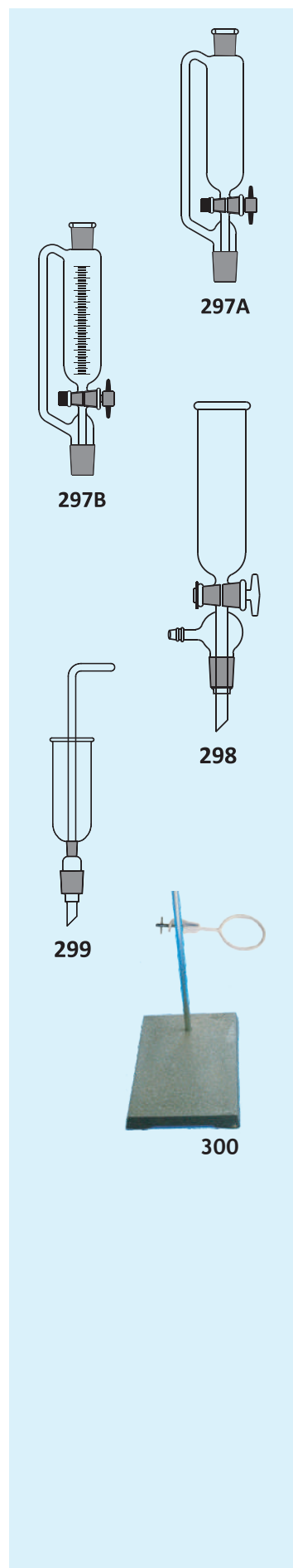

## FRACTIONATING COLUMNS

### 301 Fractionating Columns, "JSGW", Vigrex.

Cat. No.	Effective length mm.	Socket	Cone	Price/Piece (₹)
301/1	360	24/29	24/29	850.00
301/2	600	24/29	24/29	1105.00
301/3	360	29/32	29/32	980.00
301/4	750	34/35	34/35	1745.00

### 302 Fractionating Columns, "JSGW", Dufton.

Cat. No.	Effective length mm.	Socket	Cone	Price/Piece (₹)
302/1	150	24/29	19/26	815.00
302/2	300	24/29	19/26	955.00
302/3	150	24/29	24/29	850.00
302/4	300	24/29	24/29	990.00

### 303 Fractionating Columns, "JSGW", Pear Bulb.

Cat. No.	Effective length mm.	Socket	Cone	Price/Piece (₹)
303/1	130	34/35	24/29	1105.00
303/2	250	34/35	24/29	1455.00
303/3	500	34/35	24/29	2430.00

### 304 Fractionating Columns, "JSGW", Plain, designed for use with various types of columns packing.

Cat. No.	Effective length mm.	Socket	Cone	Price/Piece (₹)
304/1	250	24/29	24/29	460.00
304/2	500	24/29	24/29	645.00
304/3	750	24/29	24/29	860.00
304/4	250	34/35	24/29	975.00
304/5	500	34/35	24/29	1105.00
304/6	600	34/35	34/35	1185.00

### 305 Packing for Plain Columns, "JSGW".

Cat. No.	Description	Approx. dia. mm.	Approx. length mm.	Qty/Pack	Price/Pack (₹)
305/2	Rasching ring N.G.	8	8	100 gm	200.00
305/3	Rasching ring N.G.	10	10	100 gm	200.00
305/6	Glass Beads N.G. without Holes	3/4		500 gm	1645.00
305/7	— do —	4/5		500 gm	1465.00
305/8	— do —	5/6		500 gm	1345.00

### 306 Packing Support, "JSGW".

Cat. No.	To fit Socket Size	Diameter mm	Price/Piece (₹)
306/1	19/26	16	130.00
306/2	24/29	21	140.00
306/3	34/35	29	185.00
306/4	40/38	35	215.00



301



302



303



304

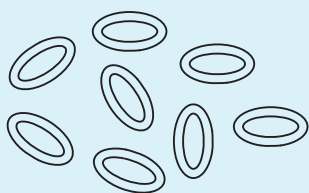

305

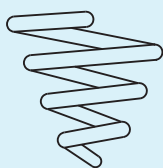

306

# SINTERED GLASSWARE

## POROSITY GRADES AND THEIR GENERAL USE

Porosity	Pore Size	General Use
G-0	150-250	Coarse Filtration, Gas dispersion and support for other filter material.
G-1	90-150	Coarse Precipitate, Filtration, Gas dispersion, Coarse grain material filtration.
G-2	40-90	Medium & Crystalline precipitate filtration, medium filtration & washing of gases.
G-3	15-40	Fine Gas filtration and dispersion, mercury filtration, fine grain material filtration, collection of fine precipitates, Analytical Work with medium precipitates.
G-4	5/15	"Valves for mercury collection of very fine precipitates. Analytical work with fine precipitate".

Price/Piece  
(₹)

325 Filtering Apparatus Witt's, "JSGW", Complete with flanged jar, flanged lid, funnel and 250 ml. beaker.

13045.00

326 Filter Apparatus, "JSGW", Complete with Filtering Flask, gooch crucible with Sintered Disc of Porosity G-1 or G-2 or G-3 or G-4, glass adapter and rubber cone.

Cat. No.	Flask Cap. ml.	Crucible Cap. ml.	Price/Piece (₹)
326/1	250	30	1185.00
326/2	500	30	1365.00
326/3	1000	50	2160.00

*Note : Please mention Porosity of Sintered Disc, while placing order.*

327 Filter Apparatus, "JSGW", Complete, Filter Flask with Socket and buchner funnel with Sintered Disc of Porosity G-1 or G-2 or G-3 or G-4, having cone.

Cat. No.	Flask Cap. ml	Buchner Funnel Cap. ml	Joint	Price/Pair (₹)
327/1	250	80	24/29	1770.00
327/2	500	200	24/29	2600.00
327/3	1000	500	29/32	5150.00
327/4	2000	1000	29/32	11465.00

*Note : Please mention Porosity of Sintered Disc, while placing order.*

328 Crucible, "JSGW", Gooch type with Sintered Disc of Porosity G-1 or G-2 or G-3 or G-4.

Cat. No.	Capacity ml.	Price/Piece (₹)
328/1	15	155.00
328/2	30	175.00
328/3	50	335.00

*Note : Please mention Porosity of Sintered Disc, while placing order.*

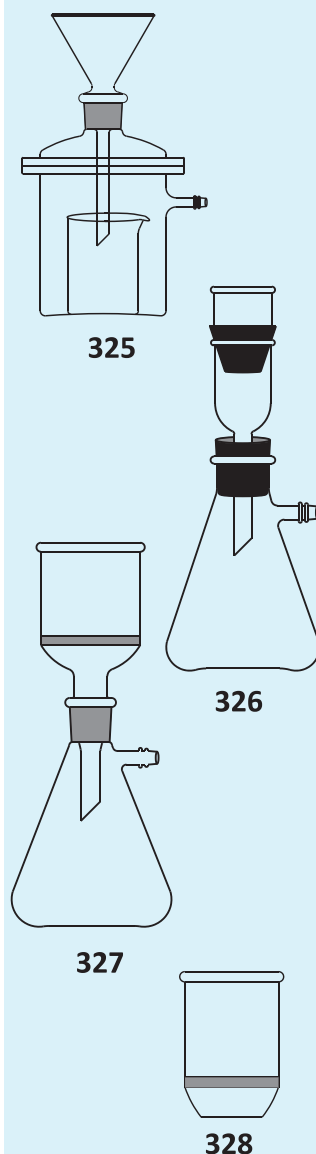

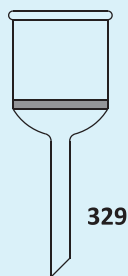

329

- 329 Buchner Funnel, "JSGW", with Sintered Disc of Porosity G-1 or G-2 or G-3 or G-4, plain stem. *(Please mention Porosity of Sintered Disc, while placing order).*

Cat. No.	Capacity ml.	Disc dia. mm.	Minimum Qty/Pack	Price/Piece (₹)
329/1	35	30	5	350.00
329/2	80	40	5	585.00
329/3	200	65	5	1185.00
329/4	500	90	5	2760.00
329/5	1000	120	2	6850.00
329/6	125	50	5	950.00

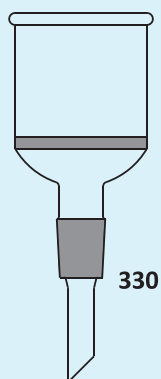

330

- 330 Buchner Funnel, "JSGW", with Sintered Disc of Porosity G-1 or G-2 or G-3 or G-4, cone at stem. *(Please mention Porosity of Sintered Disc and cone size, while placing order).*

Cat. No.	Capacity ml.	Disc Dia mm.	Cone Size	Minimum Qty/Pack	Price/Piece (₹)
330/1	35	30	14/23	5	625.00
330/1A	35	30	19/26	5	630.00
330/2	80	40	14/23	5	860.00
330/2A	80	40	19/26	5	865.00
330/3	200	65	19/26	5	1580.00
330/3A	200	65	24/29	5	1600.00
330/4	500	90	24/29	2	3320.00
330/4A	500	90	29/32	2	3410.00
330/5	1000	120	24/29	2	8140.00
330/5A	1000	120	29/32	2	8225.00
330/6	125	50	19/26	5	1350.00
330/6A	125	50	24/29	5	1365.00

- 330 V Buchner Funnel, "JSGW", with Sintered Disc of Porosity G-1 or G-2 or G-3 or G-4, cone and **Vacuum Connection** at stem.



330 V

Cat. No.	Capacity ml.	Disc Dia mm.	Cone Size	Minimum Qty/Pack	Price/Piece (₹)
330V/1	35	30	14/23	5	865.00
330V/1A	35	30	19/26	5	875.00
330V/2	80	40	14/23	5	1105.00
330V/2A	80	40	19/26	5	1110.00
330V/3	200	65	19/26	5	1830.00
330V/3A	200	65	24/29	5	1840.00
330V/4	500	90	24/29	2	3570.00
330V/4A	500	90	29/32	2	3650.00
330V/5	1000	120	24/29	2	8390.00
330V/5A	1000	120	29/32	2	8480.00
330V/6	125	50	19/26	5	1600.00
330V/6A	125	50	24/29	5	1605.00

*Please mention Porosity of Sintered Disc and cone size, while placing order.*

331 Membrane Filter Holder Assembly, "JSGW", with support formembrane, Funnel, Flask and Clamp, Standard Joint Fitting.

Cat. No.	Membrane dia. mm.	Funnel Cap. ml.	Flask Cap. ml.	Minimum Qty/Pack	Price/Piece (₹)
331/1	25	25	250	1	4230.00
331/2	25	50	500	1	4565.00
331/3	47	300	1000	1	7605.00
331/4	47	300	2000	1	8795.00
331/5	90	1000	5000	1	59205.00

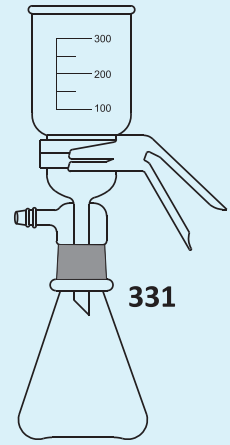

331

331A Spare Flask for Membrane Filter Holder Assembly, "JSGW".

Cat. No.	Capacity ml.	Minimum Qty/Pack	Price/Piece (₹)
331A/1	250	2	930.00
331A/2	500	2	1305.00
331A/3	1000	2	2185.00
331A/4	2000	2	3445.00
331A/5	5000	1	10155.00

331A

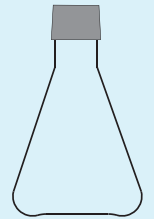

331 BT Membrane Filter Holder Assembly, "JSGW", with support for membrane, Funnel, Bottle and Clamp, Silicone Rubber Cork fitting.

Cat. No.	Membrane dia. mm.	Funnel Cap. ml.	Bottle Cap. ml.	Price/Piece (₹)
331BT/3	47	300	1000	7535.00
331BT/4	47	300	2000	8450.00



331 BT

332 Membrane Filter Holder Assembly, "JSGW", with support for membrane, Funnel, Flask and Clamp, Silicone Rubber Cork fitting.

Cat. No.	Membrane dia. mm.	Funnel Cap. ml.	Flask Cap. ml.	Price/Piece (₹)
332/1	25	25	250	3810.00
332/2	25	50	500	4230.00
332/3	47	300	1000	7105.00
332/4	47	300	2000	7780.00

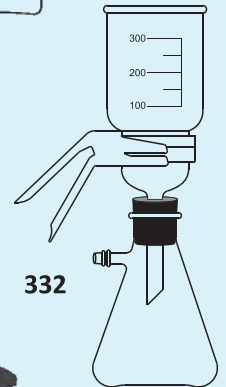

332

332A Filter Holders, Stainless Steel, (To hold Membrane Filters)

Cat. No.	Description	Price/Piece (₹)
332A/3	Vacuum Filter Holder 47 mm Complete S.S.	10770.00
332A/4	3 Branch Sterility Test, 47 mm, S.S.	68175.00
332A/5	6 Branch Sterility Test, 47 mm, S.S.	132105.00



332A/3

332 SS Filter Holder assembly, Stainless Steel, supplied with filter flask and high pressure natural rubber tube, 1 meter long.

Cat. No.	Membrane dia. mm.	Funnel Cap. ml.	Flask Cap. ml.	Price/Piece (₹)
332SS/1	47	200	1000	15155.00
332SS/2	47	200	2000	16280.00

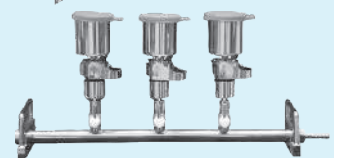

332-A/4



332-B

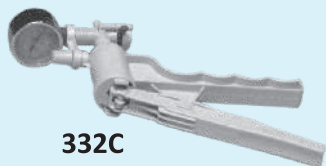

332C

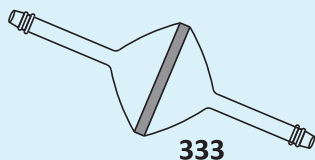

333

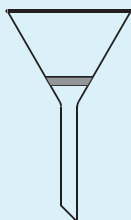

334



335

**332B Oil Free Portable Vacuum Pumps (Diaphragm Type)**

Cat. No.	Max. Flow (Its. min/in.Hg)	Max Vacuum	Max (Psig)	Motor HP	Price/Piece (₹)
332B/1	15	22"	25	1/20	16835.00
332B/2	25	27"	35	1/16	22695.00
332B/3	45	22"	35	1/8	27205.00
332B/4	45	22"	55	1/4	37455.00

**Chemical Resistant Pump, value made of Teflon**

332B/5	28	27"	55	1/8	48680.00
--------	----	-----	----	-----	----------

**332C Hand Vacuum Pump Plastic, with Gauge**

7965.00

**333 Tube Sealed, "JSGW", with reduced ends, with Sintered Disc (Pipe line filter) Porosity G-1 or G-2 or G-3 or G-4. Please mention Porosity of Sint. Disc, while placing order.**

Cat. No.	Disc Dia. mm.	Minimum Qty/Pack	Price/Piece (₹)
333/1	30	5	700.00
333/2	40	5	1050.00
333/3	50	5	1415.00
333/4	65	5	2745.00
333/5	90	5	4320.00

**334 Conical Filter, "JSGW", (Hirsch type) with Sintered Disc of Porosity G-1 or G-2 or G-3 or G-4. Please mention Porosity of Sintered Disc, while placing order.**

Cat. No.	Capacity ml.	Disc Dia. mm.	Minimum Qty/Pack	Price/Piece (₹)
334/1	20	20	5	525.00
334/2	60	30	5	625.00
334/3	175	30	5	740.00

**335 Sintered Glass Filter Tube, "JSGW", with Sintered Disc sealed in Center. Porosity G-1 or G-2 or G-3 or G-4. Please mention Porosity of Sintered Disc, while placing order.**

Cat. No.	Disc Dia. mm.	Minimum Qty/Pack	Price/Piece (₹)
335/1	10	5	340.00
335/2	20	5	435.00
335/3	30	5	595.00
335/4	40	5	995.00
335/5	50	5	1570.00
335/6	90	2	5530.00

## INTERCHANGEABLE GROUND JOINT ASSEMBLIES

- 341 **Distillation Apparatus, "JSGW"**, Consists of 500 ml. (Phenol Distillation) Flask, 200 mm. Graham condenser, and stopper 2400.00
- 342 **Distillation Apparatus, "JSGW"**, Consists of 2000 ml. Flask Friedrich condenser, and stopper. 6560.00
- 343 **Distillation Apparatus, "JSGW"**, compact, Consists of 1000 ml. Erlenmeyer Flask, and Friedrich condenser. 4465.00
- 344 **Distillation Apparatus Ammonia, "JSGW"** Consists of 500 ml. Kjeldahl Flask, splash head and Graham condenser. 2915.00
- 345 **Reflux Assemblies, "JSGW"**, Consists of R.B. Flask and Air Condenser.

Cat. No.	Flask Capacity ml.	Condenser effective length mm.	Price/Piece (₹)
345/1	100	500	850.00
345/2	250	750	875.00
345/3	500	1000	1085.00

- 346 **Reflux Assemblies, "JSGW"**, Consists of R.B. Flask and Liebig Condenser.

Cat. No.	Flask Capacity ml.	Condenser effective length mm.	Price/Piece (₹)
346/1	100	300	1085.00
346/2	250	400	1250.00
346/3	500	500	1455.00

- 347 **Reflux Assembly, "JSGW"** consists of R.B. Flask 1000 ml., and a reversible Coil Condenser. 2125.00

- 348 **Reflux Assembly, "JSGW"** consists of R.B. Flask 500 ml., multiple adapter two necks, stirrer guide, rubber sleeve gland, Link stirrer 450 mm., vertical Allihn condenser 300 mm. 3075.00

- 349 **Reflux with Stirrer Assembly, "JSGW"** consists of R.B. Flask 1000 ml. multiple adapter three necks, stirrer guide, rubber sleeve gland, collapsible paddle stirrer 450 mm., coil condenser 150 mm., drying tube, separating funnel 100 ml. and stopper. 4820.00

- 350 **Reaction Assembly, "JSGW"**, consists of R.B. flask 500 ml., multiple adapter two necks, stirrer gland with pulley, links stirrer 450 mm., still head, thermometer pocket, Liebig condenser 400 mm., receiver adapter bend with vent, R.B. flask 100 ml. 7805.00

- 351 **Reaction Assembly, "JSGW"**, consists of R.B. flask 500 ml., Liebig condenser 400 mm., adapter T. Connection, separating funnel 100ml. and stopper. 2580.00

- 352 **Distillation Assembly, "JSGW"**, consists of R.B. flask, splash head, double surface condenser and receiver adapter.

Cat. No.	Flask Capacity ml.	Condenser effective length mm.	Price/Piece (₹)
352/1	2000	200	4155.00
352/2	3000	300	6315.00
352/3	5000	400	8595.00
352/4	10000	600	15535.00

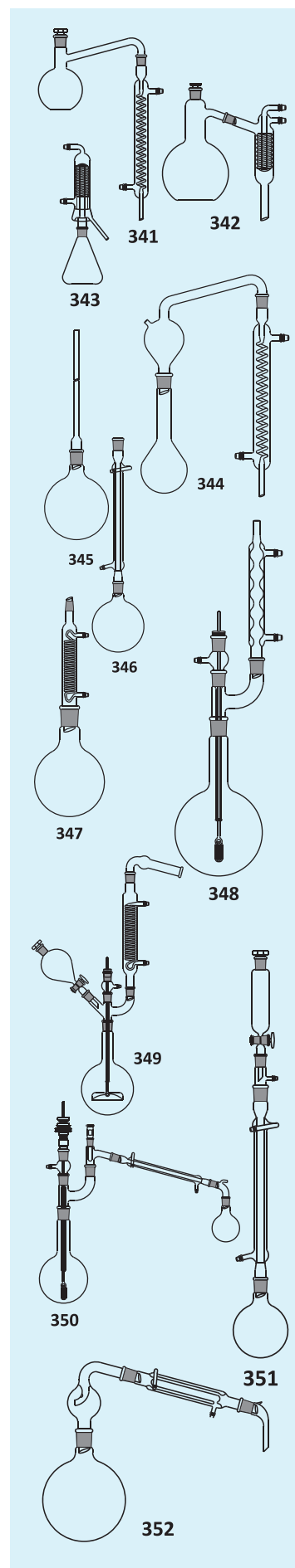

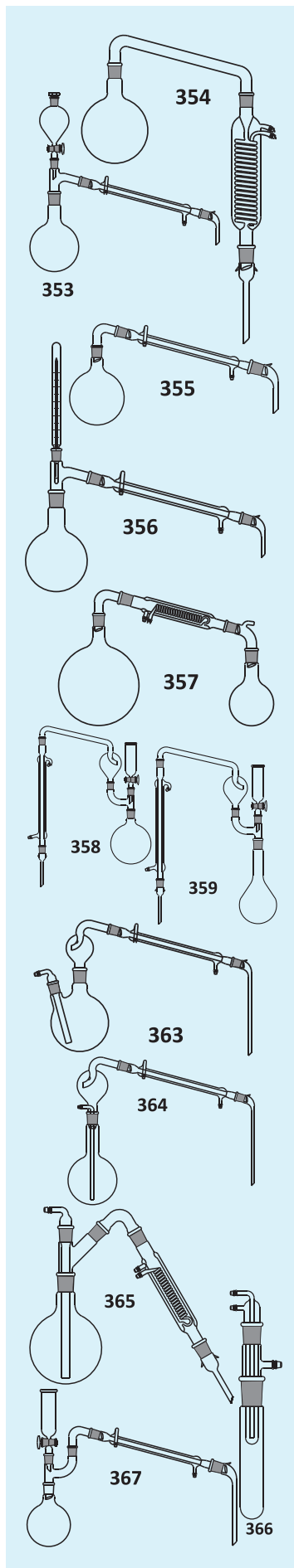

353 **Distillation Apparatus, "JSGW"**, consists of R.B. Flask 500 ml., still head, Liebig condenser 400 mm., Receiver adapter, separating funnel 100 ml. and stopper. 2995.00

354 **Alcohol Distillation unit, "JSGW"**, used for distilling alcohol in laboratory to produce the purest grade. Thoper's revenue still is for purification of ethyl alcohol popularly used in Pharma Industries. Consists of R.B. Flask 1000 ml., recovery bend, Inland revenue condenser 200 mm and receiver adapter. 3485.00

355 **Distillation Apparatus, "JSGW"**, consists of R.B. flask recovery bend, Liebig condenser and receiver adapter.

Cat. No.	Flask Capacity ml.	Condenser effective length mm.	Price/Piece (₹)
355/1	250	200	1675.00
355/2	500	300	2035.00
355/3	1000	350	2330.00
355/4	2000	400	3650.00

356 **Preparation Assembly, "JSGW"**, consists of R.B. Flask, Still head, Thermometer, Liebig Condenser and receiver adapter.

Cat. No.	Flask Capacity ml.	Condenser effective length mm.	Price/Piece (₹)
356/1	500	300	2990.00
356/2	1000	350	3410.00
356/3	2000	400	4910.00

357 **Vacuum Distillation, "JSGW"**, consists of R.B. Flask 1000 ml., recovery bend, jacketed coil condenser 150 mm., Receiver adapter bent with vent and R.B. flask 250 ml. 3485.00

358 **Kjeldahl Distillation Assembly, "JSGW"**, consists of R.B. Flask 1000 ml., multiple adapter two necks, splash head vertical, Liebig condenser, receiver adapter and dropping funnel 100 ml. 3650.00

359 **Kjeldahl Dist Assembly "JSGW"** consists of Kjeldhal flask 500 ml multiple adapter two necks, splash head vertical, Liebig condenser receiver adapter and dropping funnel 100 ml. 3985.00

363 **Steam Distillation Assembly, "JSGW"**, consists of R.B. flask 2 necks 500 ml, splash head, Liebig condenser 200 mm, receiver adapter and air leak tube. 3155.00

364 **Steam Distillation Assembly, "JSGW"**, consists of R.B. flask 500 ml, steam distillation head, Liebig condenser 400 mm, receiver adapter. 2405.00

365 **Steam Distillation Assembly, "JSGW"**, consists of R.B. Flask 1000 ml, multiple adapter two necks, recovery bend sloping, jacketed coil condenser and receiver adapter. 3335.00

366 **Vacuum Sublimation Assembly, "JSGW"**, consists of Test tube, adapter with T connection and immersion condenser. 995.00

367 **Recovery Assembly, "JSGW"**, consists of R.B. flask 250 ml., multiple adapter two necks, recovery condenser 400 mm. receiver adapter and dropping funnel 100 ml. 2910.00

368	<b>Recovery Assembly, "JSGW"</b> , consists of R.B. flask 2000 ml., still head, jacketed coil condenser 150 mm., receiver adapter, separating funnel 100 ml. and stopper.	5005.00
369	<b>Solvent Recovery Assembly, "JSGW"</b> , consists of R.B. Flask 150 ml., recovery bend, jacketed coil condenser 150 mm. And receiver adapter.	2580.00
370	<b>Solvent Recovery Assembly, "JSGW"</b> , consists of R.B. Flask 250 ml., recovery bend, sloping, Liebig condenser 400 mm., Receiver adapter bend with vent and R.B. flask 250 ml.	2495.00
371	<b>Solvent Recovery Assembly, "JSGW"</b> , consists of R.B. Flask 500 ml., recovery bend sloping, air condenser 200 mm., Ether condenser and Buchner flask 250 ml.	6980.00
372	<b>Solvent Recovery Assembly, "JSGW"</b> , consists of R.B. Flask 3000 ml., splash head adapter vertical, still head recovery with thermometer socket, Air condenser, Ether condenser, Receiver adapter, Conical flask 1000 & Thermometer	11295.00
373	<b>Fractionation Assembly, "JSGW"</b> , consists of R.B. Flask 500 ml., Cup joint adapter, Ball joint adapter, Joint Clip S-35, Air Condenser, Multiple adapter two necks parallel, Immersion Condenser, Still head recovery, thermometer pocket, Liebig condenser and receiver adapter straight.	5480.00
374	<b>Fractionation Assembly, "JSGW"</b> , consists of R.B. flask 250 ml., Air condenser, Still head recovery, Thermometer, Leibig condenser, Bend with multiple connections and vacuum connection and 3 R.B. flasks 25 ml.	4325.00
375	<b>Fractionation Assembly, "JSGW"</b> , consists of R.B. Flask 1000 ml., Swan neck adapter, Air condenser, Multiple adapter two neck at 45°, Immersion condenser, Still head, Thermometer, Leibig condenser, Ball joint adapter with socket, Cup joint adapter with cone, separating funnel 100 ml. Reduction adapter, R.B. flask 2 neck 500 ml., vacuum release stopcock and joint clip.	8970.00
376	<b>Continuous Water Distillation Assembly, "JSGW"</b> , consists of two neck flask 2000 ml., dropping funnel 100 ml., Splash head, jacketed coil condenser, receiver adapter and conical funnel.	5905.00
383	<b>Vacuum Drying Pistol, "JSGW"</b> , consists of Desiccant flask 100 ml., Boiling flask 250 ml. etc.	5480.00
384	<b>Alkoxy and Alkylimino Group Determination Apparatus, "JSGW"</b> , (Micro Zeisel).	3500.00
385	<b>Micro Acetyl Group Determination Apparatus, "JSGW"</b> , (Wiesenberger).	3485.00
386	<b>Mercury Distillation Assembly, "JSGW"</b> , Hulett, consists of distillation flask 500 ml., stopcock controlled air bleeding tube, air condenser 500 mm Liebig condenser 200 mm., vacuum receiver adapter and receiving bottle.	4240.00
390	<b>Cavett Blood Test Apparatus, "JSGW"</b> , Conical Flask 100 ml.	1125.00
392	<b>Kozellka and Hine Blood Test Apparatus, "JSGW"</b>	9060.00
393	<b>Carbaryl Content Determination Apparatus, "JSGW"</b> , as per I.S. Specification.	6470.00

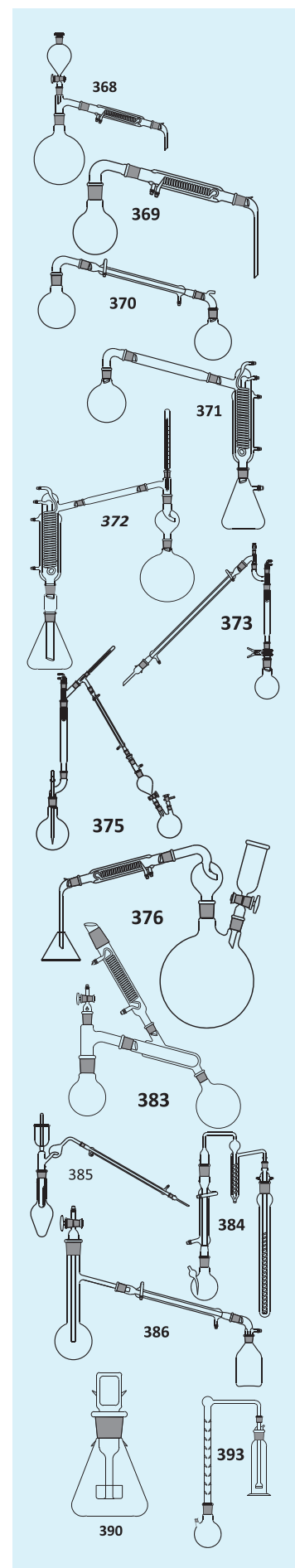

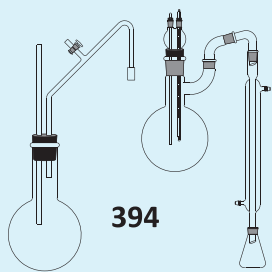

394



397

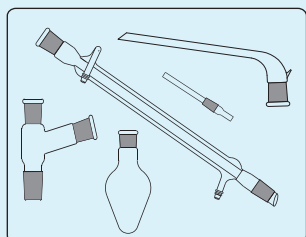

401

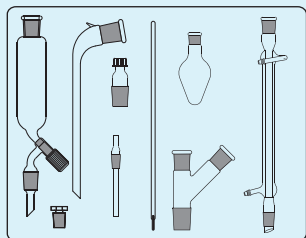

402

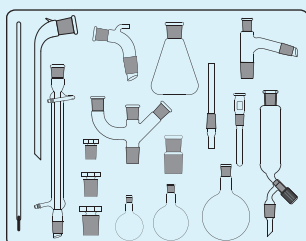

403

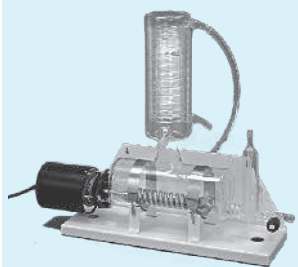

420-1

394	Steam Distillation Apparatus for Fluoride Determination as per I.S. Specification.	6150.00
395	Cyanide Distillation Appratus, "JSGW".	5815.00
396	Assembly of Appratus for the Determination of Mancozeb Content, "JSGW" IS 8707:1978.	9220.00
397	Sulfur Dioxide Assembly, as per USP, "JSGW"	7060.00
398	Congeaing Temperature Apparatus, without Thermometer	8630.00
398T	Congeaing Temperature Apparatus, "JSGW" with NABL Certified Thermometer. Range : -20°C to 150° C, Sub. Div. 0.2°C.	17435.00
399	Hydroxypropoxy Determination Apparatus, "JSGW"	12460.00
400	Methoxy Determination Assembly as per USP, "JSGW".	13285.00

## UTILITY SETS

401	Complete set comprising 5 items of Glassware, 29BU/M Pear Shaped Flask 50 ml, Still Head, Liebig Condenser, Receiver Adapter Bend, Receiver Adapter Long. 1 each.	(₹) 3650.00
402	Complete set comprising 9 items of Glassware, 27BU/M Pear Shaped Flask 50 ml, Still Head, Liebig Condenser, Screw Cap Adapter, Receiver Adapter, Air Leak/Steam Inlet Tube, Dropping Funnel 50 ml R/F STPK, Stopper & Thermometer. 1 each	(₹) 5315.00
403	Complete set comprising 16 items of Glassware, 34 BU/M Still Head, Receiver, Air Leak/Steam Inlet Tube, Liebig Condenser, Dropping Funnel 100 ml, Reducing Adapter, Multiple Adapter, R/B Flask 50 ml, 100 ml & 250 ml, Conical Flask 250 ml, Stoppers 3, Thermometer Pocket, Receiver Adapter & Thermometer.	(₹) 10625.00

## WATER STILLS

420/1	Water Still : Comprises of a horizontal borosilicate glass boiler fitted with a 3KW chromium plated immersion heater with cut off, high efficiency coil condenser ensure a reliable output of single distillate. The still is fitted on a sheet metal epoxy coated stand, suitable for bench or wall mounting. For use on 220/240 V. 50/60 Hz single phase supply. As per Picture. Distillate Output : 4 Liters/hr Approx, ph : 5 to 6.5 Pyrogen free.	(₹) 35445.00
-------	--	--------------

*Note : ph & conductivity and sensitivity are affected by temperature and the presence of absorbed carbon dioxide. The basis of tests are at 20°C on distilled water free of carbon dioxide. Care is needed to obtain Pyrogen free water and the distillate must be tested before use. Pretreated input water (use of softner) is recommended for obtaining better results and to increase the still life.*

Spares :

420/A	Boiler for Water Still	(₹) 17025.00
420/B	Condenser for Water Still	(₹) 10755.00
420/C	Heater 3KW fitted with thermostat	(₹) 10410.00

## WATER STILLS WITH SILICA SHEATHED HEATERS

- 421 Water stills are carefully designed to produce high purity pyrogen free distilled water. The water still of borosilicate glass comprises of horizontal type boiler, condenser, constant level device, silica sheathed (Quartz) heater, along with stand and clamps.

**Compact Design. All parts are replaceable.**

### Features:

- Borosilicate condenser & boiler are fitted with a removable silica sheathed heater & screw threaded connectors for ease of cleaning when scaling is formed.
- Distillate temp. is around 25 to 45 °C which is ensured by an efficient condenser.
- The stand is powder coated for rust free operation and lustrous appearance.
- The unit automatically switches off if water level in the boiler falls below heater.
- Cooling water from the condenser is re-circulated into the boiling chamber, hence saving energy.
- Boiler is provided with a Replaceable Side Over Flow for easy draining and cleaning of boiling chamber, which also reduces the chances of breakage.
- Fuse is provided for safety in case of voltage fluctuation or short circuit.
- Electrical Power: 220/240 V, 50/60Hz, Single Phase Supply.
- Unique Feature: **This model is equipped with in Built Safety Cut Off Device which protect the glass in case of water failure & Overheating.**

### Single Still

Conductivity	1 to 2.0 $\mu\text{s}/\text{cm}$			
pH	5.5-6.0			
Cat No.	Output	Cooling Water Consumption(ltr/hr)	Power Rating KW	Price/Piece (₹)
421/1	1.5 ltr/hr	40 ltr/hr	1.5 Kw	38250.00
421/2	2.5 ltr/hr	60 ltr/hr	1.7 Kw	46970.00
421/5	4.0 ltr/hr	120 ltr/hr	3.0 Kw	54355.00

### Double Still

Conductivity	0.8 to 1 $\mu\text{s}/\text{cm}$			
pH	6.0-7.0			
Cat No.	Output	Cooling Water Consumption(ltr/hr)	Power Rating KW	Price/Piece (₹)
421/3	1.5 ltr/hr	80 ltr/hr	3.0 Kw	53075.00
421/4	2.5 ltr/hr	120 ltr/hr	3.4 Kw	72835.00
421/6	4.0 ltr/hr	150 ltr/hr	6.0 Kw	106755.00

\*\* Models upto 10 ltr/hr is also available

### Spares for above Water Stills

Cat. No.	Description	Capacity ltr/hr	Price/Piece (₹)
421/7	Boiling Chamber with water leveler	1.5	10825.00
421/8	Boiling Chamber with water leveler	2.5	11615.00
421/9	Boiling Chamber with water leveler	4.0	16650.00
421/10A	Coil Condenser	1.5	8640.00
421/10	Coil Condenser	2.5	9265.00
421/11	Coil Condenser	4.0	10330.00
421/12	Silica Sheathed heater with Bakelite	1.5	6830.00
421/13	Silica Sheathed heater with Bakelite	2.5	8970.00
421/14	Silica Sheathed heater with Bakelite	4.0	12810.00

**Installation Charges for Cat. No. : 421 -R4500.00 extra.**

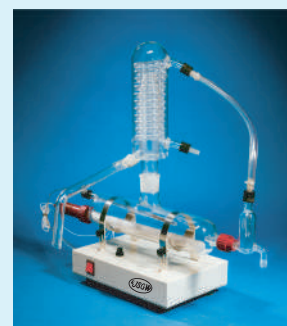

Single Still



Double Still

## 422 Automatic Water Distillation Equipment (Cabinet Model)

### Compact & User Friendly

- This is a fully automatic water distillation equipment has been designed for better and accurate control of the distillation unit and can be used in research laboratories, hospitals etc.
- It has been incorporated with advanced microprocessor based electronic circuitry.
- The alpha numeric LCD which has been used shows all messages that correspond to the running of the machine.
- Also there is alarm system which beeps as and when user attention is required.

### The distillation has following features:

- **Replaceable silica sheathed (Quartz) heater:** The horizontal quartz jacket is fitted with removable silica heater and screw threaded connectors for ease of cleaning when scaling is formed.
- Cooling water from the condenser is re-circulated into the boiling chamber, hence saving energy.
- Boiler is provided with a **Replaceable Side over Flow** for easy draining and cleaning of boiling chamber, which also reduces the chances of breakage.
- The front cover is easily removable making the access to the glass parts very easy.
- Electrical Power: 220/240 V, 50/60Hz, Single Phase Supply.

### Additional In-built Safety Features:

- **Gate Valve:** Conserves cooling water wastage in case of power failure.
- **Flow Switch:** Additional in-built safety feature for the equipment unit shut off in case of cooling water failure.
- **Temperature switch:** The boiler is equipped with a safety temperature switch which shuts off the unit if water level in the boiler falls below the heater, thus saving the glass parts from any damages.
- **Reservoir Level Sensor:** This helps in automatic working of the water distillation equipment. Depending on the water level in the reservoir it will automatically switch On/Off the equipment, thus saving energy. (Reservoir can also be provided with a storage capacity of 5 ltr, 10 ltr & 20 ltr made of Borosilicate Glass or polypropylene at an extra cost)

### Technical Specifications:

Cat. No.	Output Cap. ltr/hr	Stage	Price/Piece (₹)
422/1	2.0	Single Stage	90585.00
422/2	4.0	Single Stage	120415.00
422/3	2.0	Double Stage	151890.00
422/4	4.0	Double Stage	177150.00

### Distillate Quality

Cat. No.	Output Cap.	pH	Conductivity $\mu\text{s/cm}$	Cooling Water Requirement	Power Rating
422/1	2.0	5.5-6.0	<3.0	1.5 ltr/min	1.5 Kw
422/2	4.0	5.5-6.0	<3.0	2.5 ltr/min	3.0 Kw

\*\* Output quality would depend upon the quality of the inlet feed water to the boiler.

\*\*For high purity & low conductivity water we recommend quartz water distillations.

\*\* All parameters are under standard test conditions



422

## WATER DISTILLATIONS

425

Automatic Electrically Heated All glass Distillation Unit, N.P.L. Design, heater embedded in spiral glass tube complete with C.I. heavy base, S.S. Rod, Clamps, Board etc.

Cat. No.	Flask Cap.	Description	Price/Piece (₹)
425/1	3 Litre	Single Distillation without cut off	25680.00
425/2	3 Litre	Single Distillation with thermal sensor auto cut off	33700.00
425/3	5 Litre	Single Distillation without cut off	26640.00
425/4	5 Litre	Single Distillation with thermal sensor auto cut off	35150.00
425/5	10 Litre	Single Distillation without cut off	31775.00
425/6	10 Litre	Single Distillation with thermal sensor auto cut off	41085.00
425/7	3 Litre	Double Distillation without cut off	45740.00
425/8	3 Litre	Double Distillation with thermal sensor auto cut off	53925.00
425/9	5 Litre	Double Distillation without cut off	50070.00
425/10	5 Litre	Double Distillation with thermal sensor auto cut off	59220.00
425/11	10 Litre	Double Distillation without cut off	63395.00
425/12	10 Litre	Double Distillation with thermal sensor auto cut off	69810.00
425/13	3 Litre	Tripple Distillation without cut off	67405.00
425/14	3 Litre	Tripple Distillation with thermal sensor auto cut off	76395.00
425/15	5 Litre	Tripple Distillation w/o cut off	73500.00
425/16	5 Litre	Tripple Distillation with thermal sensor auto cut off	81530.00
425/17	10 Litre	Tripple Distillation without cut off	89075.00
425/18	10 Litre	Tripple Distillation with thermal sensor auto cut off	97095.00

### Spare Parts :

425/19	Flask with heater 3 Litre	12520.00
425/20	Flask with heater 5 Litre	13800.00
425/21	Flask with heater 10 Litre	20865.00
425/22	Condenser for 3 Litre Distillation with 40/38 Cone	4615.00
425/23	Condenser for 5 Litre Distillation with 40/38 Cone	4615.00
425/24	Condenser for 10 Litre Distillation with 50/42 Cone	5105.00
425/25	Automatic thermal sensor cut off for Single Distillation	11560.00
425/26	– do – for Double Distillation	12035.00
425/27	– do – for Tripple Distillation	13480.00
425/28	Receiving tube for condensor	855.00
425/31	Water Softner suitable for above Distillations	19255.00

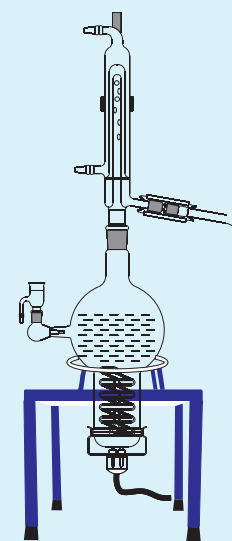

425

*Installation Charges for Cat. No. : 421, 425, 426 & 427 ₹4500.00 extra.*

## 426 Single Stage Water Distillation Unit

The apparatus consists of a boiler made from high purity quartz with built in heater and bottom discharge joint for easy cleaning of deposits. A spiral condenser is fitted on the boiler with receiving adapter. The unit comes with Safety Control Unit (Optional) to protect the Glass parts in case of water failure or overheating.

Conductivity	<3 $\mu\text{S}/\text{cm}$ with Borosilicate Condenser <2 $\mu\text{S}/\text{cm}$ with Quartz Condenser
Distilled Water Quality	Pyrogen Free
Distillate Temperature	50-60°C

### Advanced features:

- Distillate is pyrogen free; also it is free of heavy metals.
- Switch on time is less than minute providing distilled water instantly.
- Low maintenance is required.

### Single Stage Distillation with Borosilicate Glass Condenser

Cat No.	Output	Cooling Water Consumption(ltr/hr)	Power Rating KW	Price/Piece (₹)
426/1	2.5 ltr/hr	35 ltr/hr	2.0 Kw	51855.00
426/3	5 ltr/hr	65 ltr/hr	4.4 Kw	88450.00
426/6	10 ltr/hr	120 ltr/hr	9.0 Kw	194230.00

### Single Stage Distillation with Quartz Condenser

Cat No.	Output	Cooling Water Consumption(ltr/hr)	Power Rating KW	Price/Piece (₹)
426/1Q	2.5 ltr/hr	35 ltr/hr	2.0 Kw	79915.00
426/3Q	5 ltr/hr	65 ltr/hr	4.4 Kw	144570.00

### Spares for above Water Distillation units

Cat. No.	Description	Capacity ltr/hr	Price/Piece (₹)
426/A	Quartz Boiler	2.5	39650.00
426/B	Quartz Boiler	5.0	57585.00
426/C	Borosilicate Condenser	2.5	6950.00
426/D	Borosilicate Condenser	5.0	15250.00
426/E	Quartz Condenser	2.5	36835.00
426/F	Quartz Condenser	5.0	56145.00

### Safety Cut off Device for above distillations.

Automatic Thermal Sensor Safety Cut off Device which switches off the distillation unit in case of water failure or overheating.

Cat. No.	Description	Capacity ltr/hr	Price/Piece (₹)
426/G	Safety Cut Off with thermal sensors	2.5	16835.00
426/H	Safety Cut Off with thermal sensors	5.0	18545.00
426/I	Safety Cut Off with thermal sensors	10.0	39650.00

*Installation Charges for Cat. No. : 426 - ₹ 4500.00 extra.*



426

## 426/J Safety Cut off Device with Digital LCD Display

This new dual - safety cut off has been designed for better and accurate control of the distillation unit. It has been incorporated with advanced microprocessor based electronic circuitry.

This has the latest electronic technology that has been introduced by our company which gives an easy user machine interaction.

The alpha numeric LCD which has been used shows all messages that correspond to the running of the machine.

Also there is alarm system which beeps as and when user attention is required.

Extra Cost for the above Safety cut off device (₹) 38490.00

## 427 All Quartz Double Distillation

- It has been designed keeping in view customer requirements & easy serviceability of the equipment. All Quartz Double Distillation consists of demountable upper & lower boiler
- The lower boiler has a built in heater enclosed in a quartz boiler with a cup on top.
- The upper boiler has a built in quartz coil and condensing unit which is mounted on the boiler with the help of ball and socket joint.
- Double walled condenser ensures separate condensation of vapours coming from the two boilers using a single cooling circuit.
- The unit is mounted on a specially designed powder coated stand and is also provided with automatic Safety Control Unit.
- This new dual - safety cut off device has been designed for better and accurate control of the distillation unit. It has been incorporated with advanced microprocessor based electronic circuitry.
- This has the latest electronic technology that has been introduced by our company which gives an easy user machine interaction.
- The alpha numeric LCD which has been used shows all messages that correspond to the running of the machine.
- Also there is alarm system which beeps as and when user attention is required.

### Double Distillate Quality

Parameters	Values
Specific Conductivity	< 1 µs/cm
Biological Activity (distillate quality)	Pyrogen Free
Organic Matter	Nil
Total Solids	0.1 mg/ltr
Silica	<0.01 mg/ltr

*\*\* All parameters are under standard test conditions.*

*\*\*We recommend a Quartz Reservoir for storage of High Purity Water.*

Cat. No.	Output Cap. Apprx.	Power Rating	Cooling Water Consumption	Price/Piece (₹)
427/1	1.5 ltr/hr	3.0 Kw	50 ltr/hr	162970.00
427/2	2.5 ltr/hr	5.0 Kw	70 ltr/hr	247670.00
427/3	4.0 ltr/hr	8.0 Kw	120 ltr/hr	403220.00
427/4	5.0 ltr/hr	9.0 Kw	150 ltr/hr	457515.00

*\*\* Cat No. 427/3 & 427/4 are with 3 phase power supply. \*\*Cost of safety cut off device included.*

### Spares :

427/1A	Lower Boiler 1.5 ltr./hr. for Cat. No. 427/1	38130.00
427/2A	Lower Boiler 2.5 ltr./hr. for Cat. No. 427/2	49290.00
427/3A	Lower Boiler 4.0 ltr./hr. for Cat. No. 427/3	71375.00
427/4A	Lower Boiler 5.0 ltr./hr. for Cat. No. 427/4	85405.00
427/5UB	Upper Boiler with Condenser for Cat. No. 427/1	123830.00
427/6UB	Upper Boiler with Condenser for Cat. No. 427/2	184835.00
427/7UB	Upper Boiler with Condenser for Cat. No. 427/3	316600.00
427/8UB	Upper Boiler with Condenser for Cat. No. 427/4	343845.00



426J



427

## 428A All Quartz Double Distillation (Horizontal Model)

### Features

- **Replaceable Silica Heater** : The horizontal quartz jacket is fitted with removable silica heater and screw threaded connectors for ease of cleaning.
- Distillate temperature is approx. between 25° to 45° C which is ensured by an efficient condenser.
- The stand is powder coated for rust free operation and lustrous appearance.
- Cooling water from the condenser is re-circulated into the boiling chamber, hence saving energy.
- Teflon Stop cork should be provided for easy draining, cleaning and maintenance.

### Additional In-built Safety Features

- **Gate Valve** : Conserves cooling water wastage in case of power failure.
- **Flow Switch** : In-built safety feature for the equipment unit shut off in case of cooling water failure.
- **Temperature switch** : The boiler is equipped with a safety temperature switch which shuts off the unit if water level in the boiler falls below the heater, thus saving the glass parts from any damages.

This new dual - safety cut off has been designed for better and accurate control of the distillation unit. It has been incorporated with advanced microprocessor based electronic circuitry. This has the latest electronic technology that has been introduced by our company which gives an easy user machine interaction.

The alpha numeric LCD which has been used shows all messages that correspond to the running of the machine. Also there is alarm system which beeps as and when user attention is required.



### Double Distillate Quality

Parameters	Values
Specific Conductivity	0.1-0.5 $\mu\text{s}/\text{cm}$
Biological Activity (distillate quality)	Pyrogen Free
pH	6.9 - 7
Organic Matter	Nil
Total Solids	0.1 mg/ltr
Silica	<0.01 mg/ltr

*\*\* All parameters are under standard test conditions.*

*\*\*We recommend a Quartz Reservoir for storage of High Purity Water.*

Cat. No.	Output Cap. Apprx.	Power Rating	Cooling Water Consumption	Price/Piece (₹)
428AH/1	1.5 ltr/hr	3.0 Kw	50 ltr/hr	209480.00
428AH/2	2.5 ltr/hr	5.0 Kw	70 ltr/hr	290710.00
428AH/3	4.0 ltr/hr	7.0 Kw	120 ltr/hr	427505.00
428AH/4	5.0 ltr/hr	9.0 Kw	150 ltr/hr	484280.00

Indicates 3 Phase

*\*\* Cat No. 428AH are with 3 phase power supply.*

- 428 Horizontal Single Stage Quartz Distillation, Horizontal Quartz Boiler fitted with removable Silica sheathed (Quartz) heater and coil condenser with complete stand, Clamp etc. Conductivity of Distilled water produced is 1-1.5  $\mu$  S cm<sup>-1</sup>, with Borosilicate Condenser and 0.5 - 0.8  $\mu$  S cm<sup>-1</sup> with Quartz Condenser. pH 6-7, Screw threaded Connectors are provided for easy cleaning when scaling is formed. (All parts replaceable) .

Cat. No.	Boiler Type	Condenser Type	Safety Cut Off	Output Per Hr. (approx.)	Power Rating	Price/Piece (₹)
428/1	Quartz	Borosilicate	✓	2 ltr.	1.7 kw.	78695.00
428/1Q	Quartz	Quartz	✓	2 ltr.	1.7 kw.	107515.00
428/2	Quartz	Borosilicate	✓	5 ltr.	3.5 kw.	90585.00
428/2Q	Quartz	Quartz	✓	5 ltr.	3.5 kw.	157870.00



428

## 429 Water Softner

It softens the hard water and provides good quality water for use in laboratories. It helps to remove all the calcium and magnesium ions in hard water and the soft water thus obtained has hardness less than 5 ppm as CaCO<sub>3</sub>. It is specially designed for easy serviceability and recharging the resin with sodium chloride solution. The softened water can be used as feed water to the Distillation Units.

The use of hard water in boilers, would leave the boiler with a lot of scaling and sedimentation, hence to improve the quality of the distillate and for longer life of the glass/quartz boilers, it is recommended to use softened water.

(₹) 19255.00



429

## 430 Chiller

**Chiller Refrigerated Circulator** has built in circulating pump and water tank of rust proof stainless steel. The built in pump has a flow rate of 2.5 meters and internal tank capacity 25 litres. The temperature is controlled by a digital temp. Indicator cum controller.

**Construction:** The body of the chiller is mounted on a sturdy angle frame with inner chamber consisting of thick polished stainless steel reservoir with cooling coil duly soldered on the outside of the same to ensure perfect cooling from -5°C to below ambient: The hollow space between the inner chamber and outer wall is filled with high grade insulation to prevent loss of temperature the refrigeration system consisting of hermetically sealed ISI marked reputed make compressor for minimum noise level and smooth operation.

P.O.R.

## EXTRACTORS

431 Soxhlet Extraction, "JSGW", consists of Flask, Extractor and Condenser.

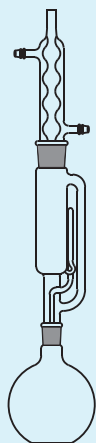

431

Cat. No.	Extractor Capacity ml.	Extractor Socket	Extractor Cone	Flask Capacity	Minimum Qty/Pack	Price/Piece (₹)
431/1	20	24/29	19/26	50	2	1650.00
431/2	40	29/32	24/29	100	2	1845.00
431/3	60	34/35	24/29	150	2	2095.00
431/4	100	34/35	24/29	250	2	2170.00
431/5	100	40/38	24/29	250	2	2295.00
431/6	200	50/42	24/29	500	2	3110.00
431/7	400	50/42	24/29	1000	2	4490.00
431/8	600	50/42	24/29	2000	1	5480.00
431/9	1000	55/44	34/35	3000	1	10645.00
431/10	2000	55/44	34/35	5000	1	20655.00
431/11	3000	55/44	34/35	10000	1	23545.00



432

432 Spare Extractor, "JSGW", for Soxhlet. Cat No. 431

Cat. No.	Capacity ml.	Socket	Cone	Qty/Pack	Price/Piece (₹)
432/1	20	24/29	19/26	2	680.00
432/2	40	29/32	24/29	2	830.00
432/3	60	34/35	24/29	2	1045.00
432/4	100	34/35	24/29	2	1085.00
432/5	100	40/38	24/29	2	1175.00
432/6	200	50/42	24/29	2	1625.00
432/7	400	50/42	24/29	2	2225.00
432/8	600	50/42	24/29	2	2530.00
432/9	1000	55/44	34/35	1	3925.00
432/10	2000	55/44	34/35	1	9770.00
432/11	3000	55/44	34/35	1	11300.00

*Note : For spare Condensers ref. Cat. No. 134, for spare Flasks ref. Cat. No. 165.*

437 Soxhlet Extraction, "JSGW", consists of R.B. Flask, Extractor with Flat flange, reduction adapter with flat flange and socket and double surface condenser.



437

Cat. No.	Extractor Cap. ml.	Flask Cap. ml.	Price/Piece (₹)
437/1	600	2000	16055.00
437/2	1000	3000	22590.00
437/3	2000	5000	26780.00
437/4	3000	10000	31865.00

438 Soxhlet Extraction, "JSGW", consists of R.B. Flask, Globular type Extractor and double surface condenser.



438

Cat. No.	Extractor Cap. ml.	Flask Cap. ml.	Price/Piece (₹)
438/1	1000	2000	12360.00
438/2	2000	3000	20085.00
438/3	3000	5000	25950.00
438/4	4000	10000	36250.00
438/5	6000	10000	54770.00

## CHROMATOGRAPHY

445 **Chromatography Assembly Semi Micro, "JSGW"**, consisting of funnel Reservoir 50 ml. capacity with 14/23 cone and socket, column tube with tap, 12 mm. dia 10mm. Effective length with 14/23 socket, 19/26 cone and fused sintered disc. Filtering flask 100 ml. with 19/26 socket tamping rod 40 cm. Long. 2955.00

446 **Chromatography Assembly, "JSGW"**, consisting of dropping funnel 250 ml. with 19/26 cone, reduction adapter with 19/26 socket and 24/29 cone. Column tube 2 cm. dia 20mm. Effective length with 24/29 socket, 19/26 cone and fused sintered disc. Adapter with tap 19/26 socket 24/29 cone, filtering flask 250 ml with 24/29 socket, tamping rod 50 cm. Long. 4155.00

449 **Chromatography Columns, "JSGW"**, with integral sintered disc., without stopcock.

Cat. No.	Effective Length cm.	Disc Dia. mm.	Minimum Qty/Pack	Price/Piece (₹)
449/1	15	10	2	435.00
449/2	20	15	2	450.00
449/3	30	15	2	465.00
449/4	40	20	2	550.00
449/5	40	30	2	790.00
449/6	50	30	2	850.00
449/7	50	40	2	1310.00
449/8	60	40	2	1375.00
449/9	100	40	2	1845.00

450 **Chromatography Columns, "JSGW"**, with integral sintered disc and Glaskey stopcock.

Cat. No.	Effective Length cm.	Disc Dia. mm.	Minimum Qty/Pack	Price/Piece (₹)
450/1	15	10	2	700.00
450/2	20	15	2	720.00
450/3	30	15	2	740.00
450/4	40	20	2	815.00
450/5	40	30	2	970.00
450/6	50	30	2	1025.00
450/7	50	40	2	1630.00
450/8	60	40	2	1675.00
450/9	100	40	2	2225.00

451 **Chromatography Columns, "JSGW"**, with integral sintered disc and screw type PTFE Needle Valve stopcock.

Cat. No.	Effective Length cm.	Disc Dia. mm.	Minimum Qty/Pack	Price/Piece (₹)
451/1	15	10	2	675.00
451/2	20	15	2	680.00
451/3	30	15	2	695.00
451/4	40	20	2	765.00
451/5	40	30	2	970.00
451/6	50	30	2	1095.00
451/7	50	40	2	1630.00
451/8	60	40	2	1675.00
451/9	100	40	2	2225.00

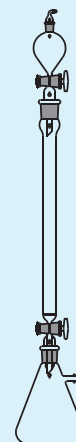

445



446



449



450



451



452

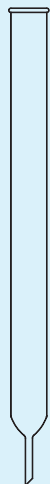

453



454



455

452 Chromatography Columns, "JSGW", with integral sintered disc and PTFE key stopcock.

Cat. No.	Effective Length cm.	Disc Dia. mm.	Minimum Qty/Pack	Price/Piece (₹)
452/1	15	10	2	1010.00
452/2	30	10	2	1040.00
452/3	30	20	2	1180.00
452/4	45	20	2	1250.00
452/5	45	30	2	1625.00
452/6	60	30	2	1685.00

453 Plain Chromatography Absorption Columns, "JSGW", without stopcock.

Cat. No.	Effective Length cm.	O.D. mm.	Minimum Qty/Pack	Price/Piece (₹)
453/1	20	10	2	110.00
453/2	30	15	2	160.00
453/3	50	20	2	350.00
453/4	60	25	2	405.00
453/5	60	40	2	880.00
453/6	100	50	2	2000.00
453/7	115	100	2	8320.00
453/8	180	100	2	13280.00

454 Chromatography Columns, "JSGW", Plain with stopcock.

Cat. No.	Effective Length cm.	O.D. mm.	Minimum Qty/Pack	Price/Piece (₹)
454/1	20	10	2	365.00
454/2	30	15	2	395.00
454/3	50	20	2	620.00
454/4	60	25	2	675.00
454/5	60	40	2	995.00
454/6	100	50	2	2500.00
454/7	115	100	2	9135.00
454/8	180	100	2	13625.00

455 Chromatography Columns, "JSGW", Plain with screw type PTFE Needle Valve stopcock.

Cat. No.	Effective Length cm.	O.D. mm.	Minimum Qty/Pack	Price/Piece (₹)
455/1	20	10	2	320.00
455/2	30	15	2	370.00
455/3	50	20	2	550.00
455/4	60	25	2	630.00
455/5	60	40	2	1145.00
455/6	100	50	2	3225.00
455/7	100	60	2	4660.00

Chromatography Column with Standard Interchangeable Joint, with Reservoir. P.O.R.

456 Chromatography Columns, "JSGW", Plain, with PTFE key stopcock.

Cat. No.	Effective Length cm.	O.D. mm.	Minimum Qty/Pack	Price/Piece (₹)
456/1	15	10	2	800.00
456/2	30	10	2	815.00
456/3	30	20	2	980.00
456/4	45	20	2	1025.00
456/5	45	30	2	1145.00
456/6	60	30	2	1290.00
456/7	100	40	2	2655.00
456/8	115	100	2	11710.00

457 Chromatography Columns, "JSGW", with integral sintered disc, Glasskey stopcock, socket and cone.

Cat. No.	I.D. mm.	Effective Length mm.	Socket	Cone	Minimum Qty/Pack	Price/Piece (₹)
457/1	10	100	14/23	19/26	2	1160.00
457/2	10	200	14/23	19/26	2	1180.00
457/3	10	300	14/23	19/26	2	1205.00
457/4	20	300	24/29	19/26	2	1255.00
457/5	20	400	24/29	19/26	2	1280.00
457/6	20	400	24/29	24/29	2	1300.00

458 Chromatography Columns, "JSGW", with integral sintered disc, socket & cone.

Cat. No.	I.D. mm.	Effective Length mm.	Socket	Cone	Minimum Qty/Pack	Price/Piece (₹)
458/1	20	200	24/29	19/26	2	740.00
458/2	20	300	24/29	19/26	2	775.00
458/3	20	400	24/29	19/26	2	815.00

459 Chromatography Column, "JSGW", Plain with socket & PTFE Stopcock.

Cat. No.	Effective Length cm	Outer Dia mm	Socket	Minimum Qty/Pack	Price/Piece (₹)
459/1	45	20	24/29	2	1210.00
459/2	50	25	24/29	2	1330.00
459/3	60	30	24/29	2	1415.00
459/4	60	40	24/29	2	2250.00
459/5	100	50	24/29	2	2970.00
459/6	100	60	24/29	2	3275.00

459A Chromatography Column, "JSGW", with integral sintered disc with socket & PTFE Stopcock.

Cat. No.	Effective Length cm	Outer Dia mm	Socket	Minimum Qty/Pack	Price/Piece (₹)
459A/1	45	20	24/29	2	1500.00
459A/2	45	30	24/29	2	1695.00
459A/3	60	30	24/29	2	1745.00
459A/4	60	40	24/29	2	2390.00
459A/5	100	40	24/29	2	2910.00

459B Reservoir for Chromatography Column, "JSGW", with Socket & Cone.

Cat. No.	Reservoir Capacity (ml)	Socket	Cone	Minimum Qty/Pack	Price/Piece (₹)
459B/1	100	24/29	24/29	2	555.00
459B/2	250	24/29	24/29	2	630.00
459B/3	500	24/29	24/29	2	810.00
459B/4	1000	24/29	24/29	2	1190.00

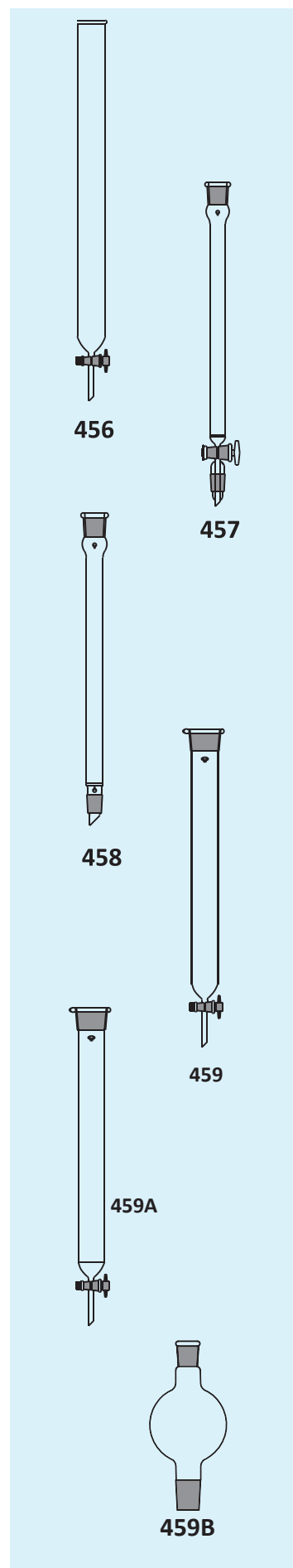

Note : Any other size of Chromatography Columns can also be supplied on Request.

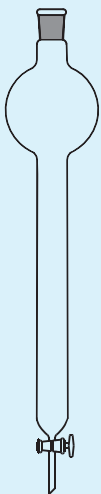

460

**460** Chromatography Columns, "JSGW", with reservoir plain with glass key stopcock.

Cat. No.	Effective Length cm.	O.D. mm.	Reservoir Capacity(ml)	Socket Size	Minimum Qty/Pack	Price/Piece (₹)
460/1	45	20	100	24/29	2	2055.00
460/2	45	20	250	24/29	2	2125.00
460/3	45	20	500	24/29	2	2490.00
460/4	45	20	1000	24/29	2	2815.00
460/5	50	25	100	24/29	2	2155.00
460/6	50	25	250	24/29	2	2225.00
460/7	50	25	500	24/29	2	2660.00
460/8	50	25	1000	24/29	2	2790.00
460/9	60	30	100	24/29	2	2225.00
460/10	60	30	250	24/29	2	2315.00
460/11	60	30	500	24/29	2	2785.00
460/12	60	30	1000	24/29	2	3005.00
460/13	60	40	100	24/29	2	3220.00
460/14	60	40	250	24/29	2	3340.00
460/15	60	40	500	24/29	2	3650.00
460/16	60	40	1000	24/29	2	3930.00
460/17	100	50	100	24/29	2	4040.00
460/18	100	50	250	24/29	2	4130.00
460/19	100	50	500	24/29	2	4465.00
460/20	100	50	1000	24/29	2	4855.00
460/21	100	60	100	24/29	2	4400.00
460/22	100	60	250	24/29	2	4500.00
460/23	100	60	500	24/29	2	4950.00
460/24	100	60	1000	24/29	2	5370.00



460A

**460A** Chromatography Columns with reservoir, "JSGW", with integral Sintered Disc with glass key stopcock.

Cat. No.	Effective Length cm.	O.D. mm.	Reservoir Capacity(ml)	Socket Size	Minimum Qty/Pack	Price/Piece (₹)
460A/1	45	20	100	24/29	2	2460.00
460A/2	45	20	250	24/29	2	2550.00
460A/3	45	20	500	24/29	2	2885.00
460A/4	45	20	1000	24/29	2	3180.00
460A/5	50	30	100	24/29	2	2550.00
460A/6	50	30	250	24/29	2	2630.00
460A/7	50	30	500	24/29	2	3090.00
460A/8	50	30	1000	24/29	2	3315.00
460A/9	60	30	100	24/29	2	2535.00
460A/10	60	30	250	24/29	2	2645.00
460A/11	60	30	500	24/29	2	3245.00
460A/12	60	30	1000	24/29	2	3625.00
460A/13	60	40	100	24/29	2	3595.00
460A/14	60	40	250	24/29	2	3675.00
460A/15	60	40	500	24/29	2	3995.00
460A/16	60	40	1000	24/29	2	4420.00
460A/17	100	40	100	24/29	2	4400.00
460A/18	100	40	250	24/29	2	4500.00
460A/19	100	40	500	24/29	2	4910.00
460A/20	100	40	1000	24/29	2	5495.00

**460B** Chromatography Columns, "JSGW", with reservoir plain with PTFE key stopcock.

Cat. No.	Effective Length cm.	O.D. mm.	Reservoir Capacity(ml)	Socket Size	Minimum Qty/Pack	Price/Piece (₹)
460B/1	45	20	100	24/29	2	2340.00
460B/2	45	20	250	24/29	2	2420.00
460B/3	45	20	500	24/29	2	2785.00
460B/4	45	20	1000	24/29	2	3105.00
460B/5	50	25	100	24/29	2	2450.00
460B/6	50	25	250	24/29	2	2520.00
460B/7	50	25	500	24/29	2	2950.00
460B/8	50	25	1000	24/29	2	3085.00
460B/9	60	30	100	24/29	2	2595.00
460B/10	60	30	250	24/29	2	2680.00
460B/11	60	30	500	24/29	2	3150.00
460B/12	60	30	1000	24/29	2	3370.00
460B/13	60	40	100	24/29	2	3625.00
460B/14	60	40	250	24/29	2	3740.00
460B/15	60	40	500	24/29	2	4060.00
460B/16	60	40	1000	24/29	2	4330.00
460B/17	100	50	100	24/29	2	4485.00
460B/18	100	50	250	24/29	2	4575.00
460B/19	100	50	500	24/29	2	4910.00
460B/20	100	50	1000	24/29	2	5300.00
460B/21	100	60	100	24/29	2	4845.00
460B/22	100	60	250	24/29	2	4945.00
460B/23	100	60	500	24/29	2	5395.00
460B/24	100	60	1000	24/29	2	5845.00



**460B**

**460C** Chromatography Columns with reservoir, "JSGW", with integral Sintered Disc with PTFE key stopcock.

Cat. No.	Effective Length cm.	O.D. mm.	Reservoir Capacity(ml)	Socket Size	Minimum Qty/Pack	Price/Piece (₹)
460C/1	45	20	100	24/29	2	2915.00
460C/2	45	20	250	24/29	2	3015.00
460C/3	45	20	500	24/29	2	3240.00
460C/4	45	20	1000	24/29	2	3695.00
460C/5	50	30	100	24/29	2	2990.00
460C/6	50	30	250	24/29	2	2940.00
460C/7	50	30	500	24/29	2	3400.00
460C/8	50	30	1000	24/29	2	3595.00
460C/9	60	30	100	24/29	2	3930.00
460C/10	60	30	250	24/29	2	3495.00
460C/11	60	30	500	24/29	2	3600.00
460C/12	60	30	1000	24/29	2	3815.00
460C/13	60	40	100	24/29	2	4070.00
460C/14	60	40	250	24/29	2	4190.00
460C/15	60	40	500	24/29	2	4450.00
460C/16	60	40	1000	24/29	2	4880.00
460C/17	100	40	100	24/29	2	4920.00
460C/18	100	40	250	24/29	2	5090.00
460C/19	100	40	500	24/29	2	5395.00
460C/20	100	40	1000	24/29	2	5770.00



**460C**



461



461A

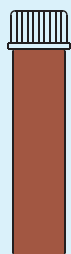

461B

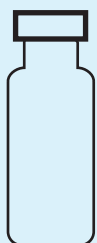

462

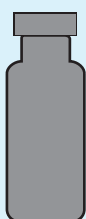

462A

**461** Vials, storage, Screw Cap, made from clear glass tubing with Silicon 1mm Septa & Cap.

Cat. No.	Capacity approx.	Dia x Length x Neck Dia mm.	Price/Pack of 100 (₹)
461/1	4ml	15 x 45 x 13	5385.00
461/2	6ml	23 x 40 x 15	6945.00
461/3	10ml	23 x 46 x 15	7185.00
461/4	20ml	23 x 75 x 15	8980.00

**461A** Vials, storage, Screw cap, made from Amber Glass tubing with silicon 1mm Septa & Cap.

Cat. No.	Capacity approx.	Dia x Length x Neck Dia mm.	Price/Pack of 100 (₹)
461A/1	4ml	15 x 45 x 13	6040.00
461A/2	6ml	23 x 40 x 15	7675.00
461A/3	10ml	23 x 46 x 15	8000.00
461A/4	20ml	23 x 75 x 15	9395.00

**461B** Vials, working standard, made from Amber Glass tubing with PP Plug, PTFE Septa & Cap.

Cat. No.	Capacity (ml)	O.D. x Length (mm)	Minimum Qty/Pack	Price/Piece (₹)
461B/1A	3	16 x 50	100	36.00
461B/1	5	16 x 55	100	43.00
461B/2	10	25 x 50	100	60.00
461B/3	15	25 x 57	100	67.00
461B/4	20	25 x 72	100	83.00
461B/5	30	25 x 95	100	108.00

**461C** Storage Box for Vials, working standard, made of 4 mm Perpex Sheets, Air tight, with individual numbering and silicone spacing.

Cat. No.	Number of Holes	Capacity (ml)	Minimum Qty/Pack	Price/Piece (₹)
461C/1	50	5 ml	5	5910.00
461C/2	50	10 ml	5	7095.00

**462** CHROMATOGRAPHY VIALS, Crimp Neck, made from Clear glass tubing with Aluminium cap and rubber stopper.

Cat. No.	Capacity approx.	Dia x Length x Neck Dia mm.	Price/Pack of 100 (₹)
462/1	4ml	16 x 33 x 13	3080.00
462/2	6ml	20 x 41 x 20	3715.00
462/3	10ml	24 x 44 x 20	4005.00
462/4	20ml	24 x 71 x 20	5710.00

**462A** CHROMATOGRAPHY VIALS, Crimp Neck, made from Amber glass tubing with Aluminium cap and rubber stopper.

Cat. No.	Volume	Dia x Length x Neck Dia mm.	Price/Pack of 100 (₹)
462A/1	4ml	16 x 33 x 13	3515.00
462A/2	6ml	20 x 41 x 20	4330.00
462A/3	10ml	24 x 44 x 20	4575.00
462A/4	20ml	24 x 71 x 20	6980.00

463 Crimping Tools for sealing vial.

Cat. No.	Size (mm)	Price/Piece (₹)
463/1	13	15500.00
463/2	20	15500.00



463

463A Decrimping Tools for De sealing vial.

Cat. No.	Size (mm)	Price/Piece (₹)
463A/1	13	15500.00
463A/2	20	15500.00



463A

464 2ml HPLC clear Glass vial With closures ( Dia 12mm x length 32mm)

Cat No.	Description	Price/Pack of 100 (₹)
464/1	9 mm, PTFE, Silicon Septa, Screw Cap with Vial	2640.00
464/2	9 mm, Preslit, PTFE, Silicon Septa, Screw Cap with Vial	2705.00
464/3	9 mm, PTFE, Silicon Septa Bonded, Screw Cap with Vial	2845.00
464/4	9mm, Preslit, PTFE, Silicon Septa, Bonded, Screw Cap with Vial	2985.00



464



Refer Cat. No. 1287 for Storage Boxes for Vials

## MOISTURE DETERMINATION UNITS

465 Moisture Determination Unit, "JSGW", Dean & Stark.

Cat. No.	Cap. of Receiver with Stopcock	Cap. of R.B. Flask ml.	Minimum Qty/Pack	Price/Piece (₹)
465/1	2 ml	250	2	2555.00
465/2	5 ml	500	2	2895.00
465/3	10 ml	1000	2	3240.00
465/4	25 ml	1000	2	3410.00

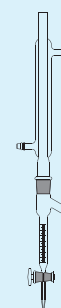

465

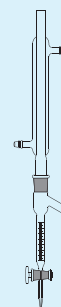

465 N

465 N Moisture Determination Unit, "JSGW", Dean & Stark, with NABL Certificate.

Cat. No.	Cap. of Receiver with Stopcock	Cap. of R.B. Flask ml.	Minimum Qty/Pack	Price/Piece (₹)
465N/1	2 ml	250	2	3240.00
465N/2	5 ml	500	2	3575.00
465N/3	10 ml	1000	2	3920.00
465N/4	25 ml	1000	2	4090.00

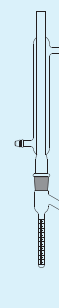

466

466 Moisture Determination Unit, "JSGW", Dean & Stark.

Cat. No.	Cap. of Receiver without Stopcock	Cap. of R.B. Flask ml.	Minimum Qty/Pack	Price/Piece (₹)
466/1	2 ml	250	2	2220.00
466/2	5 ml	500	2	2470.00
466/3	10 ml	1000	2	2815.00
466/4	25 ml	1000	2	2985.00

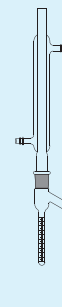

466 N

466 N Moisture Determination Unit, "JSGW", Dean & Stark, with NABL Certificate.

Cat. No.	Cap. of Receiver without Stopcock	Cap. of R.B. Flask ml.	Minimum Qty/Pack	Price/Piece (₹)
466N/1	2 ml	250	2	2895.00
466N/2	5 ml	500	2	3240.00
466N/3	10 ml	1000	2	3575.00
466N/4	25 ml	1000	2	3745.00

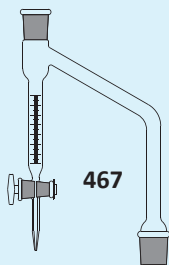

**467 Spare receiver for Dean and Stark with stopcock.**

Cat. No.	Cap. of Receiver with Stopcock	Minimum Qty/Pack	Price/Piece (₹)
467/1	2 ml	2	1625.00
467/2	5 ml	2	1625.00
467/3	10 ml	2	1625.00
467/4	25 ml	2	1625.00

**467 N Spare receiver for Dean & Stark with stopcock, Class A with NABL Certificate.**

Cat. No.	Cap. of Receiver with Stopcock	Minimum Qty/Pack	Price/Piece (₹)
467N/1	2 ml	2	2220.00
467N/2	5 ml	2	2220.00
467N/3	10 ml	2	2220.00
467N/4	25 ml	2	2220.00

**468 Spare receiver for Dean and Stark without stopcock.**

Cat. No.	Cap. of Receiver with Stopcock	Minimum Qty/Pack	Price/Piece (₹)
468/1	2 ml	2	1315.00
468/2	5 ml	2	1315.00
468/3	10 ml	2	1315.00
468/4	25 ml	2	1315.00

**468 N Spare receiver for Dean & Stark without stopcock, Class A with NABL Certificate.**

Cat. No.	Cap. of Receiver with Stopcock	Minimum Qty/Pack	Price/Piece (₹)
468N/1	2 ml	2	2070.00
468N/2	5 ml	2	2070.00
468N/3	10 ml	2	2070.00
468N/4	25 ml	2	2070.00

**469 Soil moisture gauge, "JSGW", For rapid determination of soil moisture content. The device takes less than 5 minutes, simple, inexpensive, suitable for field use. Highly useful in irrigation and compaction control programmes.**

2070.00

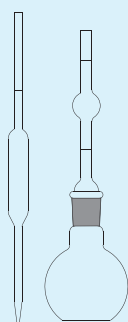

469

## ESSENTIAL OIL DETERMINATION UNIT

- 475** Essential Oil Determination Unit, "JSGW" (Clevenger Type) Vertical tube combined with condenser and measuring tube with stopcock. A return tube for the aqueous part of the distillate connects the bottom of the measuring tube & the vertical tube.

Cat. No.	Flask Capacity (ml.)	Minimum Qty/Pack	Price/Piece (₹)
475/1	1000	2	4260.00
475/2	2000	2	5035.00
475/3	3000	1	9845.00
475/4	5000	1	12010.00
475/5	10000	1	20900.00
475/6	20000	1	33950.00

- 475 S** Stand for Essential Oil Determination Unit, "JSGW" (Clevenger Type). Rectangular Cast Iron Painted Base with mild steel Chrome Plated or powdered coated rod and with boss head & 3 finger clamp.

Cat. No.	Flask Capacity	Base	Rod	Price/Piece (₹)
475S/1	1000 ml	9" x 6"	30" x 1/2"	2555.00
475S/2	2000 ml	9" x 6"	30" x 1/2"	2555.00
475S/3	3000 ml	10" x 8"	36" x 1/2"	3680.00
475S/4	5000 ml	10" x 8"	36" x 1/2"	3680.00
475S/5	10000 ml	C Type	45" x 3/4"	7755.00
475S/6	20000 ml	C Type	45" x 3/4"	8740.00

- 476** Clevenger Assembly, "JSGW" for determination of volatile oil lighter than water, comprising of 1000 ml flask, oil separatory tube and condenser. 3155.00
- 476A** Spare oil Separatory Tube. 1670.00
- 477** Clevenger Assembly, "JSGW" for determination of volatile oil heavier than water, comprising of 1000 ml flask, oil separatory tube and condenser. 3155.00
- 477A** Spare oil Separatory Tube. 1670.00

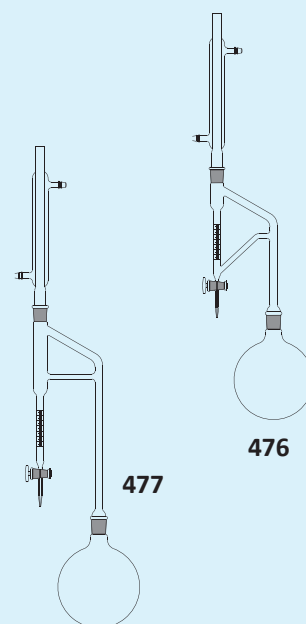
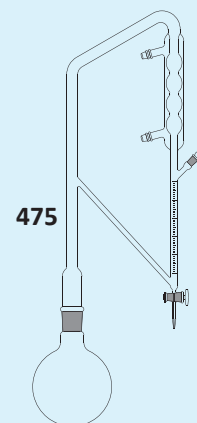

## NITROGEN DETERMINATION ASSEMBLIES

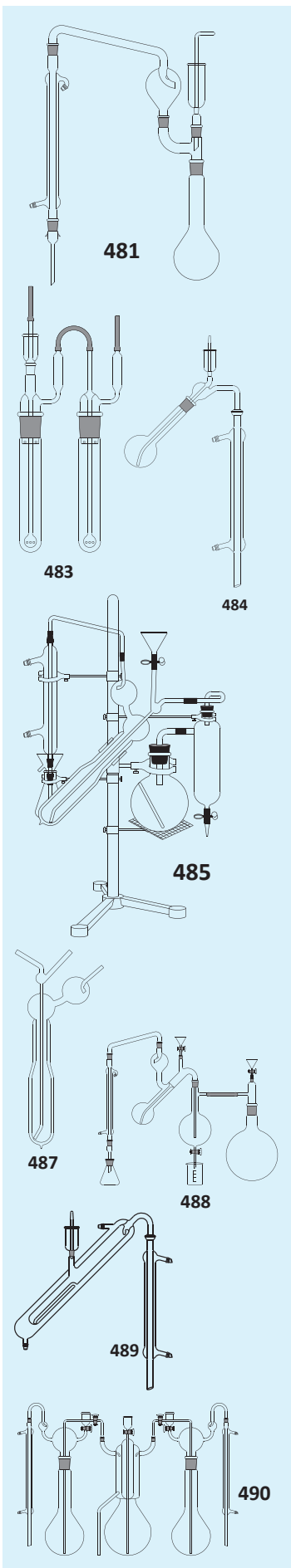

- 481** Macro Kjeldahl Distillation, "JSGW", Comprising of 500 ml Kjeldahl flask, multiple adapter, dropping funnel with plug, splash head, condenser and receiver adapter, as per Quickfit. 3990.00
- 482** Macro Kjeldahl Distillation, "JSGW", Comprising of similar parts as per Cat. No. 481, but with spherical joints in between splash head and condenser but without receiver adapter. 4805.00
- 483** Micro Nitrogen Determination, "JSGW" (Lourquin Apparatus) Ammonia is entertained in a steam of air which may be drawn through the tubes using an ordinary filter pump, digestion and distillation can be carried out in the same test tube and a number of determination can be carried out simultaneously. Alkalisiation unit comprising of absorption head with plug, aeration head and 2 test tubes. 2490.00

**484** Semi Micro Kjeldahl Unit, "JSGW"

Cat. No.	Description	Price/Piece (₹)
484/1	Comprising of 50 ml. flask, distillation head with funnel, plug and condenser.	2990.00
484/2	Comprising of parts of 484/1 apparatus but with flask capacity of 100 ml.	3155.00
484/3	Comprising of parts of 484/1 apparatus but with conical joints instead of spherical joints.	2415.00
484/4	Comprising of parts of 484/2 apparatus but with conical joints instead of spherical joints.	2390.00

- 485** Micro Kjeldahl Nitrogen Distillation Assembly, "JSGW", (Pregl. Parnas and Wagner Apparatus) comprising of steam generation flask, steam trap, vacuum jacketed flask with funnel, condenser tube of silver and receiving flask, complete with heavy duty stand, brass clamps but without burner.

Cat. No.	Description	Price/Piece (₹)
485/3	– do – glass tube condenser and 1000 ml. Steam generating flask	10385.00
485/4	– do – with glass tube condenser and 2000 ml. Steam generating Flask.	11380.00

**Spare Parts :**

- 486** Spare Silver Tube with Condenser for Cat. No. 485/1 or 485/2 P.O.R
- 487** Spare vacuum Jacket for Cat. No. 485 2250.00
- 488** Parnas and Wagner Assembly 10460.00

**489** Markham Semi Micro Distillation Unit, "JSGW"

Cat. No.	Description	Price/Piece (₹)
489/1	Comprising of Markham still body with enclosed evaporator vessel in a combined steam jacket & trap, funnel plug, condenser and spherical joint clip.	4985.00
489/2	Comprising similar parts but with conical joints and receiver adapter.	4155.00

**490** Nitrogen Distillation Assembly, "JSGW" (Kemmerer, Hellet Design) Micro.

Cat. No.	Description	Price/Piece (₹)
490/1	Double stage for distillation of two samples.	12230.00
490/2	Single stage for distillation of one sample.	8745.00

## STOPCOCKS

### 501 Stopcock, Straight Bore, "JSGW"

Cat. No.	Description	Price/Piece (₹)	
		Bore 2 mm.	Bore 4 mm.
501/1	With Solid Plug, side Tube	205.00	340.00
501/2	With Solid Plug, Side Capillary	215.00	350.00

### 502 Stopcock, Oblique Bore, "JSGW"

Cat. No.	Description	Price/Piece (₹)	
		Bore 2 mm.	Bore 4 mm.
502/1	With Solid Plug, side Tube	260.00	395.00
502/2	With Solid Plug, Side Capillary	275.00	420.00

### 503 Stopcock, Three Way, T, Bore, "JSGW"

Cat. No.	Description	Price/Piece (₹)	
		Bore 2 mm.	Bore 4 mm.
503/1	With Solid Plug, side Tube	395.00	465.00
503/2	With Solid Plug, Side Capillary	435.00	505.00

### 504 Stopcock, Three Way Double Oblique Bore, "JSGW"

Cat. No.	Description	Minimum Qty/Pack	Price/Piece (₹)
			Bore 2 mm.
504/1	With Solid Plug, side Tube	10	460.00
504/2	With Solid Plug, Side Capillary	10	480.00

### 507 Stopcock for Burette, "JSGW"

Cat. No.	Description	Minimum Qty/Pack	Price/Piece
			(₹)
507/1	With Solid Plug	10	175.00
507/2	With Hollow Plug	10	515.00
507/3	With PTFE Plug	10	650.00
507/4	With PTFE Needle Valve Screw type	10	175.00

### 508 Stopcock C Bore, "JSGW" Three way.

Cat. No.	Description	Minimum Qty/Pack	Price/Piece (₹)
			Bore 2 mm.
508/1	With Solid Plug, side tube	10	515.00
508/2	With solid Tube, Side Capillary	10	530.00

### 509 Stopcock for Separating Funnels.

Cat. No.	Bore mm.	Minimum Qty/Pack	Price/Piece
			(₹)
509/1	2	10	285.00
509/2	4	10	350.00
509/3	6	10	800.00

### 510 Stopcock for Aspirators 4 mm. Bore.

Cat. No.		Minimum Qty/Pack	Price/Piece
			(₹)
510/1	Plain	10	270.00
510/2	With 24/29 Cone	10	505.00
510/3	With 29/32 Cone	10	585.00

### 511 Stopcock for Kipp's Apparatus, with Cone.

5	505.00
---	--------

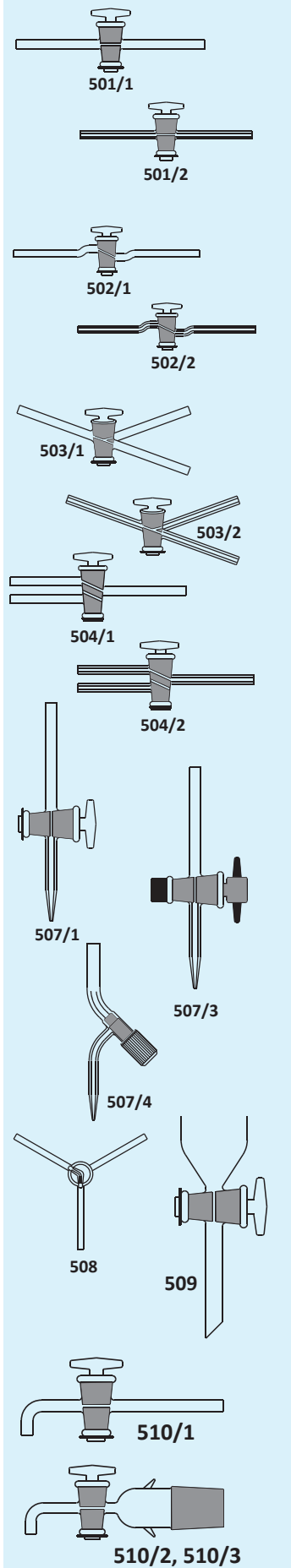

## SCREW TYPE, PTFE KEY STOPCOCKS

515 Stopcock screw type, PTFE key, with Two Plain limbs.

Cat. No.	Limbs O.D. mm.	Minimum Qty/Pack	Price/Piece (₹)
515/1	8	10	165.00
515/2	10	10	350.00
515/3	12	10	480.00

516 Stopcock, Screw Type, PTFE key, with two limbs, Capillary Bore 2 mm.

185.00

517 Stopcock Screw Type, PTFE key, with Two Plain Limbs at Right Angle.

Cat. No.	Limbs O.D. mm.	Minimum Qty/Pack	Price/Piece (₹)
517/1	8	10	190.00
517/2	10	10	370.00
517/3	12	10	530.00

518 Stopcock, Screw Type, PTFE key, with two Limbs at Right Angle, Capillary Bore 2 mm.

240.00

## PTFE KEY STOPCOCKS

525 Stopcock Straight Bore with PTFE key, "JSGW".

Cat. No.	Body Wide End I.D. mm.	Key Bore mm.	Minimum Qty/Pack	Price/Piece (₹)
525/2	12	2	5	645.00
525/3	14	3	5	785.00
525/4	16	4	5	1045.00
525/5	19	6	5	1500.00
525/6	24	8	5	2825.00

526 Stopcock for Burette, Straight Bore, with PTFE key "JSGW".

625.00

527 Stopcock for Burettes, Double Oblique Bore, with PTFE key "JSGW".

1115.00

528 Stopcock for Separating Funnel, 2 m.m. Bore, with PTFE key "JSGW". Body Wide End I.D. 14 mm.

825.00

528/1 Same as Cat. No. 528, 4 m.m. Body Size I.D. 16 mm.

1085.00

530 Stopcock Double Oblique Bore with PTFE key, "JSGW".

Cat. No.	Key Bore mm.	Minimum Qty/Pack	Price/Piece (₹)
530/1	2	2	1995.00
530/2	4	2	2490.00

531 Stopcock, T Bore with PTFE key, "JSGW".

Cat. No.	Key Bore mm.	Minimum Qty/Pack	Price/Piece (₹)
531/1	2	2	1500.00
531/2	4	2	2490.00

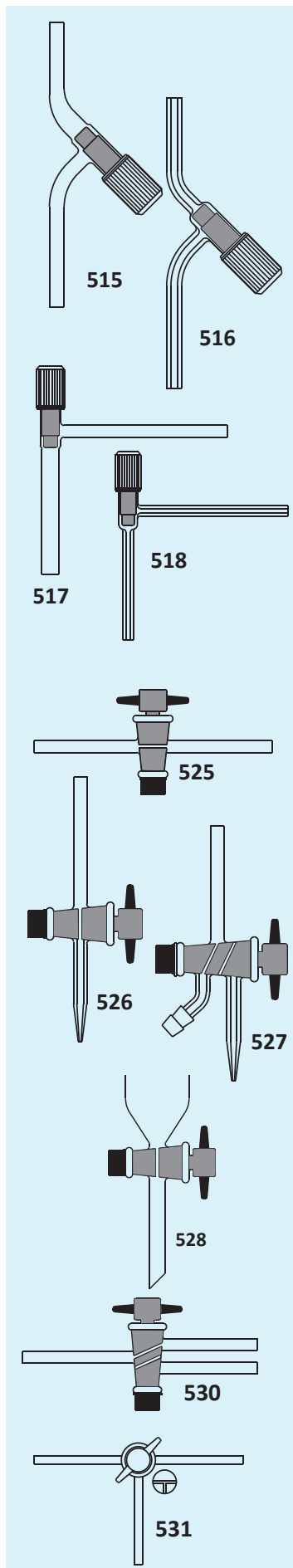

## HIGH VACUUM STOPCOCKS

536 Stopcock, Straight Bore, with hollow plug, High Vacuum, "JSGW".

Cat. No.	Plug Bore mm.	Qty/Pack	Price/Piece (₹)
536/1	2	10	550.00
536/2	4	10	760.00
536/3	6	2	1145.00
536/4	8	2	1465.00

537 Stopcock Single Oblique Bore, with hollow plug, High Vacuum "JSGW".

Cat. No.	Plug Bore mm.	Qty/Pack	Price/Piece (₹)
537/1	2	5	595.00
537/2	4	5	815.00
537/3	6	5	1250.00
537/4	8	5	1580.00

538 Stopcock, Three Way Double Oblique Bore, High Vacuum, "JSGW".

Cat. No.	Plug Bore mm.	Qty/Pack	Price/Piece (₹)
538/1	2	5	915.00
538/2	4	5	1105.00
538/3	6	5	1810.00

539 Stopcock, T Bore, Hollow Plug, High Vacuum, "JSGW".

Cat. No.	Plug Bore mm.	Qty/Pack	Price/Piece (₹)
539/1	2	5	1105.00
539/2	4	5	1810.00

540 Stopcock, L Type, Lower Limb bent at Right Angle, Hollow Plug, High Vacuum, "JSGW".

Cat. No.	Plug Bore mm.	Qty/Pack	Price/Piece (₹)
540/1	2	5	460.00
540/2	4	5	585.00
540/3	6	5	750.00

541 Stopcock, L Type, Lower Limb Vertical, Hollow Plug, High Vacuum, "JSGW".

Cat. No.	Plug Bore mm.	Qty/Pack	Price/Piece (₹)
541/1	2	5	460.00
541/2	4	5	585.00
541/3	6	5	725.00

542 Stopcock, L Type, Two Limb with Mercury Cup, Lower Limb Vertical, Hollow Plug, High Vacuum, "JSGW".

Cat. No.	Plug Bore mm.	Qty/Pack	Price/Piece (₹)
542/1	2	5	620.00
542/2	4	5	750.00
542/3	6	5	850.00

543 Stopcock, L Type, Three Limb, Hollow Plug, High Vacuum, "JSGW".

Cat. No.	Plug Bore mm.	Qty/Pack	Price/Piece (₹)
543/1	2	5	1060.00
543/2	4	5	1780.00

544 Stopcock, Mercury Cup, Two Limb, Hollow Plug, High Vacuum, "JSGW".

Cat. No.	Plug Bore mm.	Qty/Pack	Price/Piece (₹)
544/1	2	5	1180.00
544/2	4	5	1995.00

545 Stopcock, Mercury Cup, Three Limb, Hollow Plug, High Vacuum, "JSGW".

Cat. No.	Plug Bore mm.	Qty/Pack	Price/Piece (₹)
545/1	1	5	1180.00
545/2	2	5	1995.00

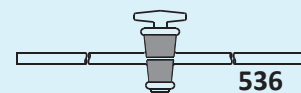

536

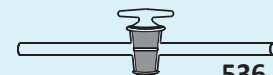

537

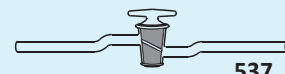

538

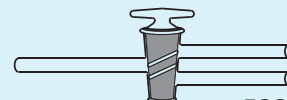

539



540

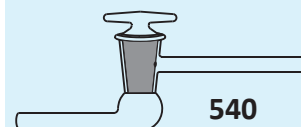

541

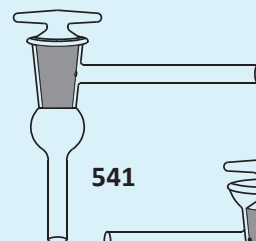

542

542

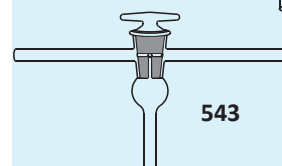

543

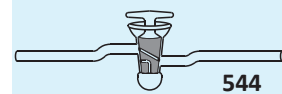

544

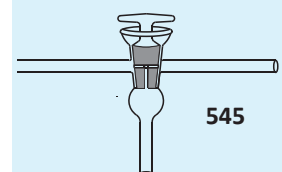

545

## BEAKERS

### 547 Beakers, Low form, "JSGW" with spout & plastic handle.

Cat. No.	Capacity ml.	Minimum Qty/pack	Price/Piece (₹)
547/5	500	5	650.00
547/8	800	5	760.00
547/10	1000	5	850.00

### 548 Beakers Low form, "JSGW" with spout, Graduated.

Cat. No.	Capacity ml.	Minimum Qty/pack	Price/Piece (₹)
548/1	50	20	105.00
548/1-ISI	50	20	115.00
548/2	100	20	110.00
548/2-ISI	100	20	125.00
548/3	150	20	115.00
548/3-ISI	150	20	130.00
548/4	250	20	125.00
548/4-ISI	250	20	135.00
548/5	400	12	200.00
548/6	500	12	200.00
548/7	600	12	260.00
548/8	1000	12	398.00
548/9	2000	4	945.00
548/10	3000	2	2125.00
548/11	5000	2	3050.00
548/12	10000	1	9595.00
548/13	5	20	130.00
548/14	10	20	130.00
548/15	25	20	120.00

### 548A Amber Colour Beakers Low form, "JSGW" with spout, Graduated.

Cat. No.	Capacity ml.	Minimum Qty/pack	Price/Piece (₹)
548A/1	50	10	320.00
548A/2	100	10	450.00
548A/3	150	10	485.00
548A/4	250	6	560.00
548A/5	500	6	865.00

### 549 Beakers Tall form, "JSGW" with spout, Graduated.

Cat. No.	Capacity ml.	Minimum Qty/pack	Price/Piece (₹)
549/1	50	20	160.00
549/2	100	20	185.00
549/3	150	20	200.00
549/4	250	12	205.00
549/5	500	12	275.00
549/6	1000	12	545.00

### 549 A Beakers Tall form, "JSGW" without spout, Graduated.

Cat. No.	Capacity ml.	Minimum Qty/pack	Price/Piece (₹)
549A/1	50	20	160.00
549A/2	100	20	185.00
549A/3	150	20	200.00
549A/4	250	12	200.00
549A/5	500	12	275.00
549A/6	1000	12	545.00

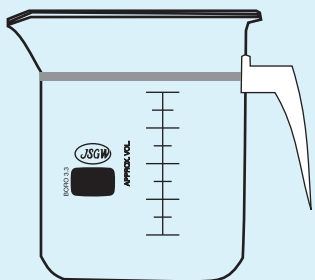

547

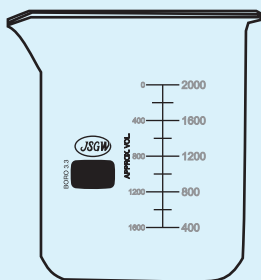

548

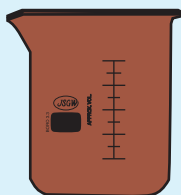

548A

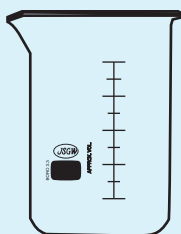

549

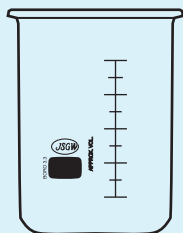

549 A

550 Beakers Philips, Conical with spout. "JSGW".

Cat. No.	Capacity ml.	Minimum Qty./pack	Price/Piece (₹)
550/1	250	2	685.00
550/2	500	2	865.00

550 A Tong for holding Beaker 12" long, Stainless Steel 470.00

550 B Brush, Beaker, made of Nylon Bristle. (Pk.of 10 Pcs.) 1045.00

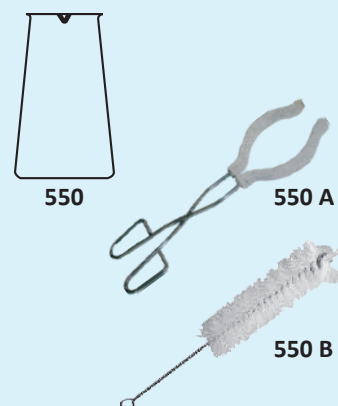

## BOTTLES

551 Weighing Bottles, "JSGW", with interchangeable stopper.

Cat. No.	O.D. x Ht. mm. (approx.)	Capacity ml.	Minimum Qty./Pack	Price/Piece (₹)
551/1 Squate form	40 x 30	20	12	405.00
551/2	50 x 25	15	12	505.00
551/3	50 x 35	25	12	540.00
551/4	50 x 50	50	12	560.00
551/5	60 x 40	40	12	710.00
551/6 Tall form	20 x 40	5	12	230.00
551/7	25 x 60	15	12	255.00
551/8	30 x 65	25	12	305.00
551/9	40 x 90	60	12	480.00

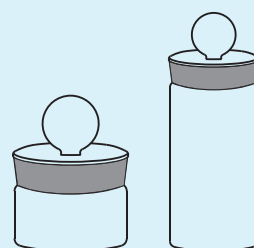

551

551 A Amber Colour Weighing Bottles, "JSGW", with interchangeable stopper.

Cat. No.	O.D. x Ht. mm. (approx.)	Capacity ml.	Minimum Qty./Pack	Price/Piece (₹)
551A/1 Squate form	40 x 30	20	12	690.00
551A/2	50 x 25	15	12	850.00
551A/3	50 x 35	25	12	930.00
551A/4	50 x 50	50	12	970.00
551A/5	60 x 40	40	12	1155.00
551A/6 Tall form	20 x 40	5	12	405.00
551A/7	25 x 60	15	12	440.00
551A/8	30 x 65	25	12	565.00
551A/9	40 x 90	60	12	835.00

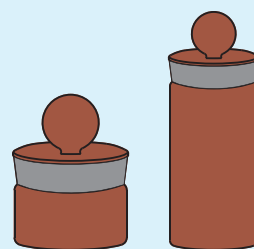

551A

553 Weighing Bottles, "JSGW", Tall Form, Cap Type.

Cat. No.	O.D. x Ht. mm. (approx.)	Capacity ml.	Minimum Qty./Pack	Price/Piece (₹)
553/1	18 x 40	7	12	290.00
553/2	28 x 50	25	12	325.00
553/3	38 x 60	55	12	495.00
553/4	45 x 80	100	12	555.00

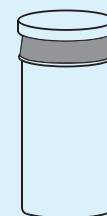

553

554 Weighing Bottles, "JSGW", Squate Form, Cap Type.

Cat. No.	O.D. x Ht. mm. (approx.)	Capacity ml.	Minimum Qty./Pack	Price/Piece (₹)
554/1	38 x 30	25	12	490.00
554/2	45 x 30	45	12	540.00

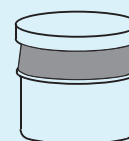

554

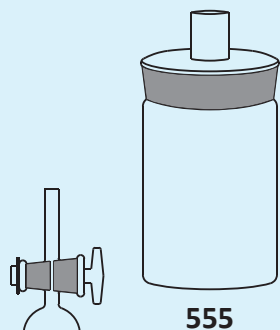

555

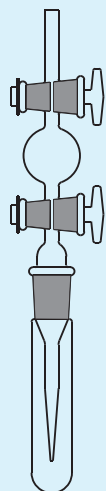

556

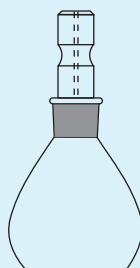

557

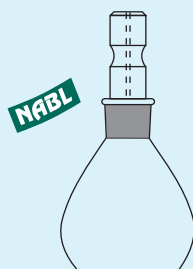

557 N

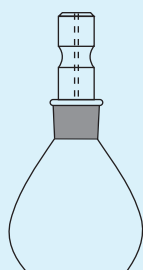

558

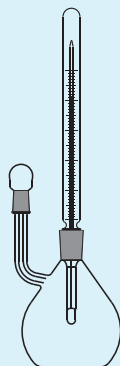

559 A

555 Bottles Wide Mouth, "JSGW", with interchangeable stopper for 15 mm. Suba Seals.

Cat. No.	O.D. x Ht. mm. (approx.)	Capacity ml.	Minimum Qty./Pack	Price/Piece (₹)
555/1	30 x 60	25	12	360.00
555/2	40 x 80	60	12	480.00
555/3	50 x 80	100	12	585.00
555/4	60 x 100	250	12	830.00
555/5	75 x 130	500	12	1390.00
555/6	90 x 180	1000	12	2000.00

556 Weighing Bottle Lunge's, 25 ml. "JSGW", for weighing Corrosive liquids. 950.00

557 Specific Gravity Bottles, "JSGW", with Capillary Bore interchangeable Teflon stopper, Class A, with Works Certificate. *Note* : \* With Glass Capillary Stopper.

Cat. No.	Capacity ml.	Tolerance ± ml.	Minimum Qty./Pack	Price/Piece (₹)
*557/1	* 5	0.1	5	685.00
557/2	10	0.3	5	650.00
557/3	20	0.8	5	775.00
557/4	25	0.8	5	785.00
557/5	50	1.0	5	820.00
557/6	100	2.0	5	985.00

557 N Specific Gravity Bottles, "JSGW", Capillary Bore interchangeable Teflon stopper, Class A, with NABL Works Certificate.

Cat. No.	Capacity ml.	Tolerance ± ml.	Minimum Qty./Pack	Price/Piece (₹)
*557N/1	* 5	0.1	2	1285.00
557N/2	10	0.3	2	1255.00
557N/3	20	0.8	2	1380.00
557N/4	25	0.8	2	1390.00
557N/5	50	1.0	2	1420.00
557N/6	100	2.0	2	1790.00

558 Specific Gravity Bottles, "JSGW", Capillary Bore interchangeable Teflon stopper.

Cat. No.	Capacity ml.	Minimum Qty./Pack	Price/Piece (₹)
558/1	5	12	395.00
558/2	10	12	380.00
558/3	20	12	380.00
558/4	25	12	395.00
558/5	50	12	425.00
558/6	100	6	500.00

559A Specific Gravity Bottles, "JSGW", Class A with Ground in thermometer range 0 to 50°C, with works Certificate. (Pyknometer)

Cat. No.	Capacity ml.	Minimum Qty./Pack	Price/Piece (₹)
559A/1	25	4	1365.00
559A/2	50	4	1440.00
559A/3	10	4	1390.00

559AN Specific Gravity Bottles, (Pyknometer) "JSGW", Class A with NABL Work Certificate of Flask & Thermometer. Ground in thermometer range 0 to 50 °C.

Cat. No.	Capacity ml.	Minimum Qty/Pack	Price/Piece (₹)
559AN/1	25	4	1975.00
559AN/2	50	4	2045.00
559AN/3	10	4	2005.00

560 Specific Gravity Bottles, Weld, "JSGW", with Cap.

Cat. No.	Capacity ml.	Inner Joint	Outer Joint	Price/Pair (₹)
560/1	10	10/19	14/23	1005.00
560/2	25	10/19	14/23	1010.00
560/3	50	10/19	14/23	1470.00

561 Specific Gravity Bottle, "JSGW", Hubbard, Conical, 25 ml. Cap. 780.00

562 Specific Gravity Bottle, "JSGW", Hubbard, Cylindrical, 25 ml. Cap. 715.00

562 M Antibiotic Moisture Content Flask "JSGW" as per USP, Class A with Certificate, 2.2 ml. 2615.00

563 Reagent Bottles, "JSGW", Narrow Mouth, with interchangeable flat head, Solid Glass Stopper.

Cat. No.	Capacity ml.	Stopper Size	Minimum Qty/Pack	Price/Piece (₹)
563/1	30	14/23	12	295.00
563/2	60	14/23	12	360.00
563/3-1	100	19/26	12	480.00
563/3	125	19/26	12	480.00
563/4	250	19/26	12	520.00
563/5	500	24/29	12	635.00
563/6	1000	29/32	6	915.00
563/7	2000	34/35	6	1745.00
563/7-3	3000	45/40	2	3600.00
563/8	5000	45/40	1	9395.00
563/9	10000	55/44	1	14695.00

563A Amber Colour, Reagent Bottles, "JSGW", Narrow Mouth, with interchangeable flat head, Solid Glass Stopper.

Cat. No.	Capacity ml.	Stopper Size	Minimum Qty/Pack	Price/Piece (₹)
563A/1	30	14/23	12	600.00
563A/2	60	14/23	12	805.00
563A/3-1	100	19/26	12	850.00
563A/3	125	19/26	12	850.00
563A/4	250	19/26	12	1060.00
563A/5	500	24/29	12	1310.00
563A/6	1000	29/32	6	1995.00
563A/7	2000	34/35	6	3365.00

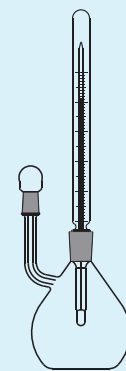

559 AN



560

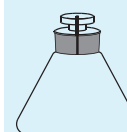

561



562



562M

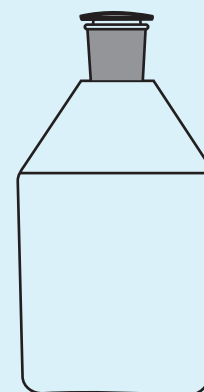

563

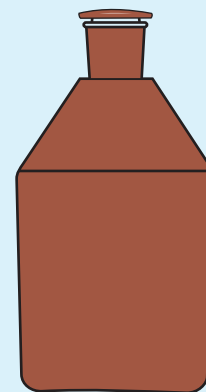

563A

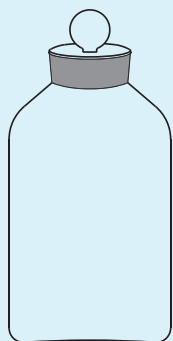

564

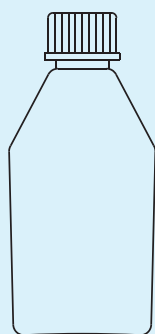

565

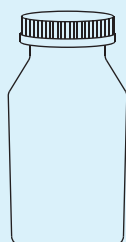

566

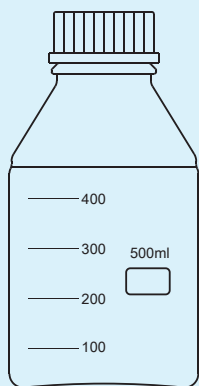

566A

**564 Reagent Bottles, "JSGW", Wide Mouth, with interchangeable hollow Stopper.**

Cat. No.	Capacity ml.	Minimum Qty/Pack	Price/Piece (₹)
564/1	30	6	320.00
564/2	60	6	385.00
564/3	125	6	600.00
564/4	250	2	945.00
564/5	500	2	1200.00
564/6	1000	1	1835.00
564/7	2000	1	2400.00

**565 Reagent Bottles, "JSGW", Narrow Mouth, with Bakelite Screw Cap and PTFE/Rubber liner.**

Cat. No.	Capacity ml.	Minimum Qty/Pack	Price/Piece (₹)
565/1	30	6	285.00
565/2	60	6	350.00
565/3	125	6	530.00
565/4	250	2	680.00
565/5	500	2	955.00
565/6	1000	1	1715.00
565/7	2000	1	2205.00

**566 Reagent Bottles, "JSGW", Wide Mouth, with Bakelite screw cap and Rubber liner.**

Cat. No.	Capacity ml.	Minimum Qty/Pack	Price/Piece (₹)
566/1	30	6	295.00
566/2	60	6	360.00
566/3	125	6	455.00
566/4	250	2	740.00
566/5	500	2	1070.00

**566A Reagent Bottle "JSGW" Clear, wide mouth with PP Blue screw cap and pouring ring, repeatedly autoclaveable, Graduated. Printed with Retrace Code.**

Cat. No.	Capacity ml.	DIN Thread	Minimum Qty/Pack	Price/Piece (₹)
566A/1	25	GL25	10	390.00
566A/2	50	GL32	10	445.00
566A/3	100	GL45	10	450.00
566A/3A	150	GL45	10	490.00
566A/4	250	GL45	10	455.00
566A/5	500	GL45	10	505.00
566A/6	1000	GL45	10	775.00
566A/7	2000	GL45	2	1380.00
566A/7-3	3000	GL45	2	6755.00
566A/8	5000	GL45	1	7245.00
566A/9	10000	GL45	1	12305.00
566A/10	20000	GL45	1	23850.00
566A/11	10	GL25	10	370.00

**566B Reagent Bottle “JSGW” Amber Colour, wide mouth with PP Blue screw cap & pouring ring, repeatedly autoclaveable, Graduated. Printed with Retrace Code.**

Cat. No.	Capacity ml.	DIN Thread	Minimum Qty/Pack	Price/Piece (₹)
566B/1	25	GL25	10	655.00
566B/2	50	GL32	10	770.00
566B/3	100	GL45	10	915.00
566B/3A	150	GL45	10	980.00
566B/4	250	GL45	10	980.00
566B/5	500	GL45	10	1160.00
566B/6	1000	GL45	10	1560.00
566B/7	2000	GL45	2	2935.00
566B/7-3	3000	GL45	2	15270.00
566B/8	5000	GL45	2	15880.00
566B/9	10000	GL45	1	23035.00
566B/10	20000	GL45	1	34975.00
566B/11	10	GL25	10	720.00

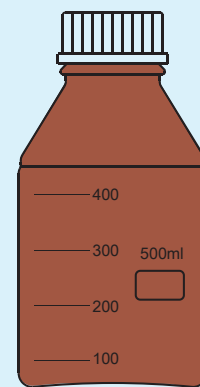

566B

**566C Caps, PP Screw Cap with Pouring Ring for Laboratory Reagent Bottles.**

Cat. No.	Colour	DIN Thread	Minimum Qty/Pack	Price/Piece (₹)
566C/1	Blue	GL 45	10	95.00
566C/2	Orange	GL 45	10	115.00
566C/3	Yellow	GL 45	10	115.00
566C/4	Green	GL 45	10	115.00
566C/5	Grey	GL 45	10	115.00
566C/6	Blue	Pouring Ring	10	28.00



566 C

**567 Reagent Bottle “JSGW” Clear, extra wide mouth with Polypropylene Blue screw cap and with pouring ring, repeatedly autoclaveable, Graduated.**

Cat. No.	Capacity ml.	DIN Thread	Minimum Qty/Pack	Price/Piece (₹)
567/5	500	GL80	10	1520.00
567/6	1000	GL80	10	2270.00
567/7	2000	GL80	2	4130.00
567/8	5000	GL80	1	10905.00
567/9	10000	GL80	1	18740.00
567/10	20000	GL80	1	37475.00



567

**567A Reagent Bottle “JSGW” Amber Colour, extra wide mouth with Polypropylene Blue screw cap & pouring ring, repeatedly autoclaveable, Graduated.**

Cat. No.	Capacity ml.	DIN Thread	Minimum Qty/Pack	Price/Piece (₹)
567A/5	500	GL80	10	2395.00
567A/6	1000	GL80	10	3555.00
567A/7	2000	GL80	2	6525.00
567A/8	5000	GL80	1	19885.00
567A/9	10000	GL80	1	27215.00
567A/10	20000	GL80	1	56520.00

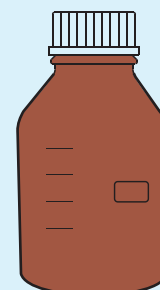

567A

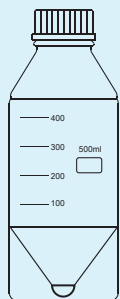

568

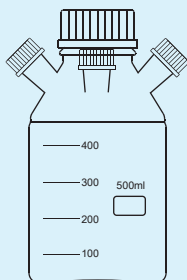

569



570



570 A

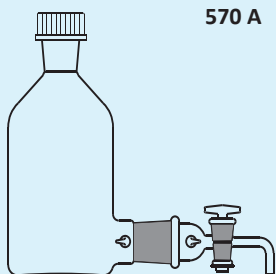

571

568 Reagent Bottle, High Recovery, "JSGW" Clear, wide mouth with Conical Bottom delivers all solvent without tilting with autoclavable PP Screw Cap GL45.

Cat. No.	Capacity ml.	Minimum Qty./Pack	Price/Piece (₹)
568/1	500	1	2480.00
568/2	1000	1	3925.00
568/3	2000	1	7435.00
568/4	3000	1	10325.00
568/5	5000	1	14455.00

569 Reagent Bottle, Clear Glass, "JSGW", with Multi-Neck with autoclavable PP Screw Cap GL45 (These bottles are used for additional solvent pouring or purging).

Cat. No.	Capacity ml.	No. of Necks	Minimum Qty./Pack	Price/Piece (₹)
569/1	500	2	1	1770.00
569/2	500	5	1	4130.00
569/3	1000	2	1	2595.00
569/4	1000	5	1	6490.00
569/5	2000	2	1	5310.00
569/6	2000	5	1	9205.00

570 Dropping Bottles, "JSGW", fitted with I/C stopper and silicone rubber teat.

Cat. No.	Capacity ml.	Minimum Qty./Pack	Price/Piece (₹)
570/1	30	12	395.00
570/2	60	12	460.00
570/3	125	12	595.00
570/4	250	12	785.00

570A Amber Colour, Dropping Bottles, "JSGW", fitted with interchangeable stopper & rubber teat.

Cat. No.	Capacity ml.	Minimum Qty./Pack	Price/Piece (₹)
570A/1	30	12	760.00
570A/2	60	12	1020.00
570A/3	125	12	1125.00
570A/4	250	12	1455.00

571 Bottles Aspirator, "JSGW", with Screw Cap, Glass key stopcock with interchangeable joint.

Cat. No.	Capacity ml.	Minimum Qty./Pack	Price/Piece (₹)
571/1	1000	2	3080.00
571/2	2000	2	3575.00
571/2-3	3000	2	10630.00
571/3	5000	1	1280.00
571/4	10000	1	18235.00
571/5	20000	1	26575.00

571A Bottles Aspirator, "JSGW", with I/C Socket & Tubulation.

Cat. No.	Capacity ml.	Minimum Qty./Pack	Price/Piece (₹)
571A/1	250	2	565.00
571A/2	500	2	725.00
571A/3	1000	2	1155.00
571A/4	2000	2	1790.00

573 Woulf Bottles, "JSGW", with two standard joint necks.

Cat. No.	Capacity ml.	Minimum Qty/Pack	Price/Piece (₹)
573/1	250	6	785.00
573/2	500	6	920.00

574 Mac-Cartney Bottles, "JSGW", Complete with Aluminium Cap.

Cat. No.	Capacity ml.	Minimum Qty/Pack	Price/Piece (₹)
574/1	15	25	105.00
574/2	30	25	110.00
574/3	60	25	150.00

575 Bottles, B.O.D. with I/C glass stopper "JSGW", with Individual number.

Cat. No.	Capacity ml.	Minimum Qty/Pack	Price/Piece (₹)
575/1	125	12	595.00
575/2	300	12	765.00
575/3	60	12	500.00

576 Roux, Culture Bottle, Off-Set Neck "JSGW"

Cat. No.	Capacity ml.	Neck I.D. (approx.) mm.	Approx. Ht.	Approx. Cross Section mm.	Price/Piece (₹)
576	1000	26	255	120 x 55	2425.00

## CLINICAL LABORATORY GLASSWARE

		Minimum Qty/Pack	Price/Piece (₹)	
580	Albuinometer, "JSGW", Esbach's in case.	10	445.00	
581	Ureometer Doremus, "JSGW", with stop cock for rapid determination in urine.	2	950.00	
582	Ureometer Doremus, "JSGW", without stopcock.	2	660.00	
583	Blood Sugar Tubes, "JSGW", Folin Wu, as per I.S. 3740 : 1966, Capacity 25 ml., marked at 4 ml, 12.5 ml. And 25 ml.	10	325.00	
584	Tubes, Digestion, "JSGW", Folin-Wu, marked at 35 ml. and 50 ml., 25 mm O.D. x 200 mm. length.	10	125.00	
585	Wintrobe Tubes, "JSGW", 100 mm. graduated.	25	70.00	
587	E.S.R. Tube, 200 mm. graduated, 300 mm. Long.	10	120.00	
588	Tube for Kahn and Wasserman test, 75 x 12 mm.	50	13.00	
589	Kahn's Antigen Dilution Tube, "JSGW", 55 x 18 mm. Flat bottom	50	32.00	
590	Wasserman Tube, "JSGW", Rimless.			
	Cat. No.	Size mm.	Minimum Qty/Pack	Price/Piece (₹)
	590/1	50 x 10	100	13.00
	590/2	75 x 10	100	13.00
591	Dreyer's Agglutination Tube, Conical bottom.	50	26.00	

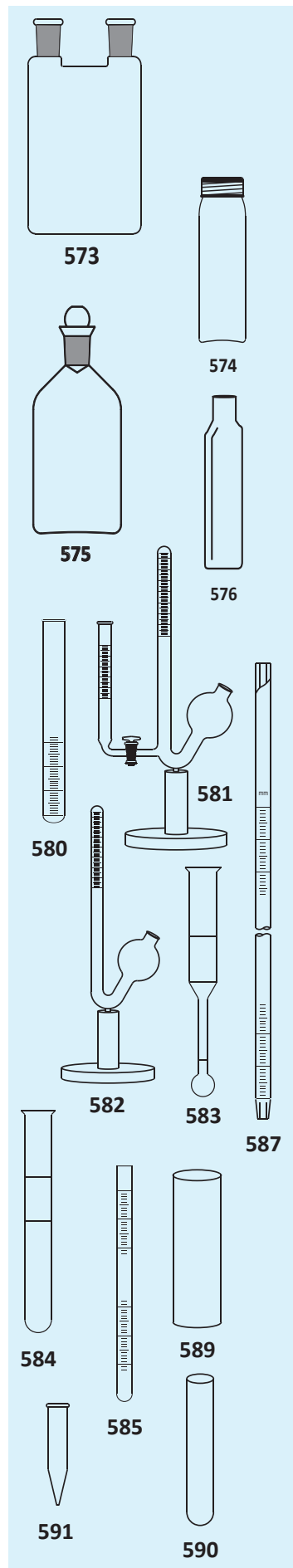

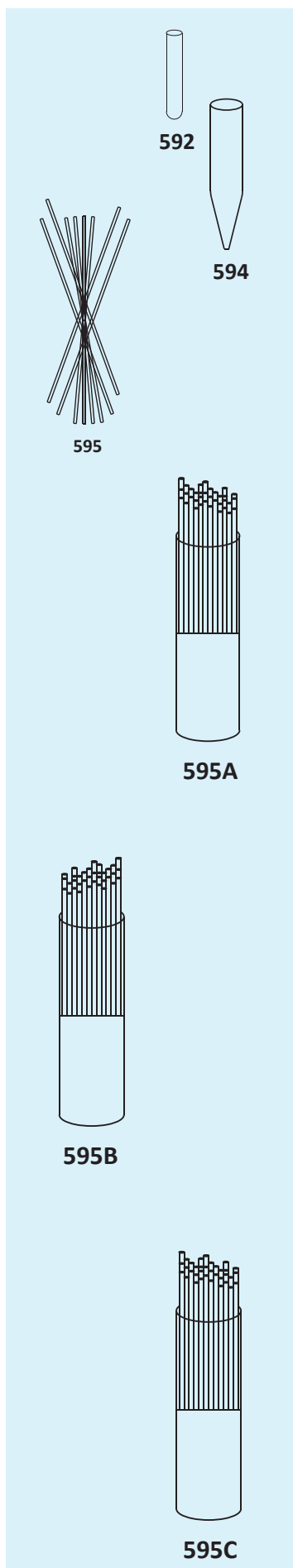

**592 Durham Tube, "JSGW"**

Cat. No.	Size mm.	Minimum Qty/Pack	Price/Piece (₹)
592/1	25 x 6	100	11.00
592/2	37 x 6	100	11.00
592/3	50 x 6	100	13.00

**594 Widal Tube Conical Bottom, "JSGW"**

		50	33.00
--	--	----	-------

**595 Co-Agulation Tubes (melting point tube)**

capillary length, 100 mm. one end sealed, Pack of 100 pcs. 175.00

**595/1 Co-Agulation Tubes (melting point tube)**

capillary length, 100 mm. both end open, Pack of 100 pcs. 168.00

**595A Graduated Micro Capillary Pipettes, Disposable, calibrated "to contain"**

Cat. No.	Cap. $\mu$ l.	Graduation $\mu$ l.	Colour Code	Price/250 Pcs. (₹)
595A/1	05	1,2,3,4 & 5	White	1330.00
595A/2	05	5	White	1270.00
595A/3	10	10	Orange	1270.00
595A/4	10	5 & 10	Orange	1330.00
595A/5	20	10 & 20	Black	1270.00
595A/6	20	20	Black	1270.00
595A/7	25	25	White	1270.00
595A/8	44	44.7	Purple	1330.00
595A/9	50	50	Green	1270.00
595A/10	100	100	Blue	1270.00
595A/11	200	200	Red	1330.00

**595B Graduated Micro Capillary Pipettes, without colour coded and single mark.**

Cat. No.	Capacity $\mu$ l.	Length mm.	Price/250 Pcs. (₹)
595B/1	5	90	1330.00
595B/2	10	90	1330.00
595B/3	20	90	1330.00
595B/4	25	90	1330.00
595B/5	50	90	1330.00
595B/6	100	90	1330.00
595B/7	200	90	1330.00

**595C End to End Capillary Pipettes, Disposable**

Cat. No.	Capacity $\mu$ l.	Length mm.	Price/250 Pcs. (₹)
595C/1	01.0	32.00	1265.00
595C/2	02.0	32.00	1265.00
595C/3	03.0	41.10	1265.00
595C/4	04.0	53.50	1265.00
595C/5	05.0	67.00	1265.00
595C/6	10.0	50.00	1265.00
595C/7	20.0	66.00	1265.00
595C/8	25.0	76.00	1265.00
595C/9	44.7	57.00	1265.00
595C/10	50.0	64.00	1265.00
595C/11	100.0	90.00	1265.00
595C/12	TLC	100.00	1220.00

**595D Haematocrit Capillaries**, colour Blue for Non Heperinsed and Red for heperinsed.

Cat. No.	Description	Price/Vial (₹)
595D/1	75mm non herperinsed capillary (100/vial)	161.00
595D/2	75mm herperinsed capillary (100/vial)	243.00
595D/3	125mm non herperinsed blood gas analyzer (100/vial)	638.00
595D/4	125mm herperinsed blood gas analyzer (100/vial)	1070.00
595D/5	90mm B.T.C.T. (100/Vial)	121.00
595D/6	Mice bleeding capillary (100/vial)	425.00
595D/7	Rat bleeding capillary (100/vial)	425.00
595D/8	Rabbit bleeding capillary (100/vial)	425.00
595D/9	32mm strmia non herperinsed capillary (100/vial)	121.00
595D/10	32mm strmia herperinsed capillary (100/vial)	213.00



**595D**

**597 Micro Slide** : 75 x 25mm Prepared from high quality thin glass, 1.00-1.2mm thick packed with Paper in between each slide and sealed in transparent P.P. Envelope, Pk. of 50.

Cat. No.	Type	Price/Pk. (₹)
597/1	Ground Edges	167.00
597/4	Ground Edges & one side at one end 19mm frosted surface	214.00



**597/1**



**597/4**

**597A Micro Concavity Slides** : 75x75x1.45mm, spherical concavities are 15-18 mm dia, 0.5 to 0.6mm deep, bevelled and polished edges, Pk. of 10.

Cat. No.	No. of Concavities	Price/Pk. (₹)
597A/1	One	130.00
597A/2	Two	150.00
597A/3	Three	184.00



**597A**



**597B**

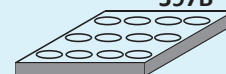

**597C**

**597B V.D.R.L. Slides (Kline Concavity Slides)** : 75x56x3mm., Concavities 16mm. Dia, 1.75mm. deep, Polished edges, frosted surface. 12 concavities. Price/Pk. 215.00

**597C Blood Grouping Slides** : 100 x 100 x 10mm. thick, 12 concavities of 21mm. Dia x 1.5mm. deep, frosted surface (One slide). Price/Pk. 510.00

**599 Counting Chamber**, Neubauer, Double Ruling, Silverlite. Price/Pk. 4030.00

**600 Haemocytometer** in box with counting chamber, Cover glasses pair, R.B.C. and W.B.C. Pipettes with rubber suction tubing and mouth piece. Price/Pk. 4575.00

**601 R.B.C. Pipette** with suction tube and mouthpiece Price/Pk. 224.00

**602 W.B.C. Pipette** with suction tube and mouthpiece Price/Pk. 224.00

**603 Petri Dishes**, Borosilicate 33 expansion Glass

Cat. No.	O.D. x Ht. mm. (approx.)	Minimum Qty/Pack	Price/Piece (₹)
603/1	50x17	10	200.00
603/2	62x17	10	230.00
603/3	80x17	10	240.00
603/4	100x17	10	285.00
603/5	150x20	10	955.00
603/6	200x20	10	2190.00
603/7	90x17	10	255.00



**599**



**600**

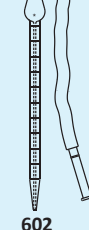
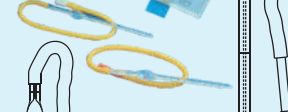

**602**

**601**



**603**

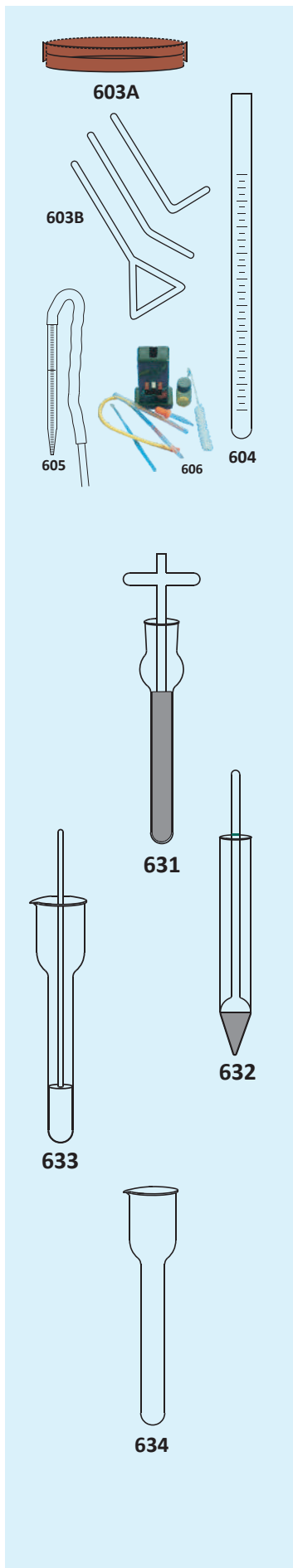

**603A Amber Colour Petri Dishes, Borosilicate 33 expansion Glass**

Cat. No.	O.D. x Ht. mm. (approx.)	Minimum Qty/Pack	Price/Piece (₹)
603A/1	50x17	10	565.00
603A/2	62x17	10	675.00
603A/3	80x17	10	800.00
603A/4	100x17	10	855.00

**603B Glass Spreader** Min. Qty/Pack Price/Piece (₹)

603B/1	Spreader L Shape	10	190.00
603B/2	Spreader Lower Portion at angle	10	260.00
603B/3	Spreader Triangular 50mm	10	340.00

**604 Haemometer Tube** 10 155.00

**605 Haemometer Pipette 20µl** 10 125.00

**606 Haemometer Complete Set** 1 1660.00

## TISSUE HOMOGENISERS

**631 Tissue Grinders Ten Broeck Type, "JSGW"**

Cat. No.	Vessel length mm.	Vessel O.D. mm.	Capacity Approx. ml.	Minimum Qty/Pack	Price/Piece (₹)
631/1	100	13	2	5	645.00
631/2	130	16	7	5	675.00
631/3	150	18	15	5	800.00
631/4	210	25	40	5	885.00

**632 Tissue Grinders, "JSGW", Homogenisers.**

Cat. No.	Vessel length mm.	Vessel O.D. mm.	Minimum Qty/Pack	Price/Piece (₹)
632/1	100	13	5	430.00
632/2	150	16	5	515.00
632/3	150	18	5	570.00
632/4	200	18	5	600.00

**633 Teflon Pestle Tissue Homogenisers, "JSGW",** having stainless steel rod, replaceable vessel of Borosilicate glass for the preparation of tissue homogenates.

Cat. No.	Capacity ml.	Minimum Qty/Pack	Price/Piece (₹)
633/1	10	5	785.00
633/2	30	5	1180.00
633/3	50	5	1645.00
633/4	100	5	1955.00
633/5	5	5	750.00

**634 Spare Glass Vessel, "JSGW", for Cat. No. 633.**

Cat. No.	Capacity ml.	Minimum Qty/Pack	Price/Piece (₹)
634/1	10	5	370.00
634/2	30	5	525.00
634/3	50	5	680.00
634/4	100	5	785.00
634/5	5	5	365.00

## CONWAY DIFFUSION UNIT

640 Conway Type Diffusion Unit, "JSGW", with Cover.

Cat. No.	Outer Dish O.D. x Ht. (mm)	Inner Chamber O.D. x Ht. (mm)	Minimum Qty./Pack	Price/Piece (₹)
640/1	50 x 17	25 x 5	5	680.00
640/2	80 x 17	35 x 5	5	720.00
640/3	100 x 17	40 x 5	5	1070.00

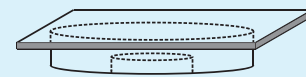

640

## CULTURE FLASKS

645 Trypsinising Flasks, "JSGW", for Culture, with four Baffles.

Cat. No.	Flask Capacity ml.	Minimum Qty./Pack	Price/Piece (₹)
645/1	25	12	315.00
645/2	50	12	500.00
645/3	100	12	550.00
645/4	250	6	810.00
645/5	500	6	980.00
645/6	1000	4	1505.00

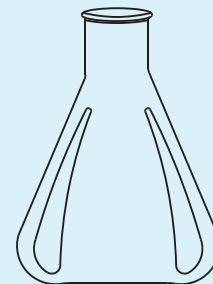

645

655 Ampoules Freeze Drying, "JSGW", Round/Flat Bottom

Cat. No.	Capacity ml.	Neck O.D. mm.	Overall length mm.	Minimum Qty./Pack	Price/Piece (₹)
655/1	1	7	80	50	21.00
655/2	2	8	140	50	38.00
655/3	3	8	163	50	40.00
655/4	5	8	167	50	46.00
655/5	10	8	180	50	53.00
655/6	15	8	180	50	60.00
655/7	20	8	195	50	95.00
655/8	25	8	200	50	95.00
655/9	50	8	230	50	155.00
655/10	100	8	240	50	215.00



655

658 Ampoules Freeze Drying, "JSGW", Tubular.

Cat. No.	Capacity ml.	Neck O.D. mm.	Overall length mm.	Minimum Qty./Pack	Price/Piece (₹)
658/1	0.5	6	112	50	15.00
658/2	1	7	127	50	17.00
658/3	2	8	147	50	19.00
658/4	3	10	147	50	24.00
658/5	4	10	170	50	26.00



658

## GLASSWARE FOR GASES

661 Gas Desorber, "JSGW" 10795.00

662 Impinger, "JSGW", graduated for sampling small gas volumes as per standard specification.

Cat. No.	Capacity ml.	Minimum Qty./Pack	Price/Piece (₹)
662/1	35	10	560.00
662/2	50	10	620.00
662/3	80	10	725.00
662/4	150	5	930.00
662/5	275	5	1250.00

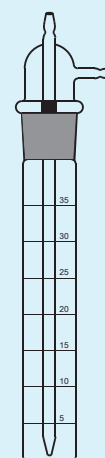

662

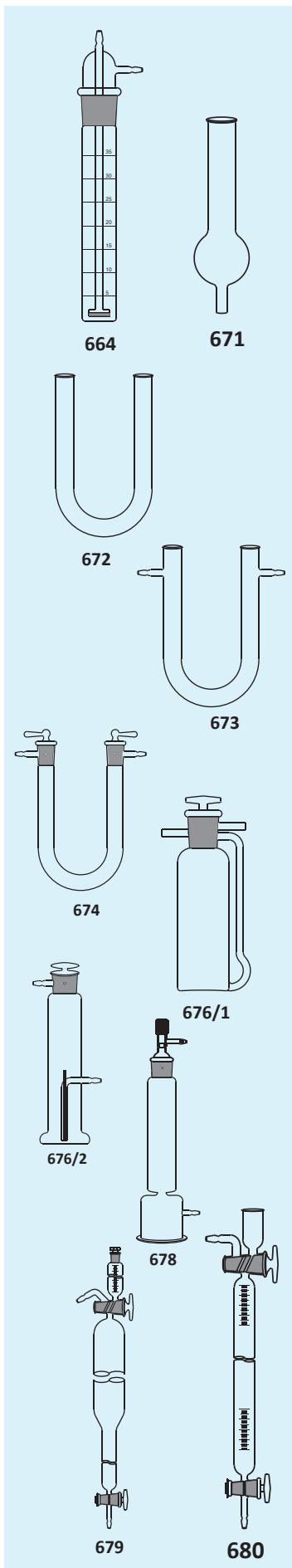

- 663 Large Size Impinger, "JSGW", used in an impinger train to collect gases and particles from air and gases. Cap. 500 ml. graduated at 100 ml., 250 ml. and 500 ml. 2610.00
- 664 Impinger Bubbler Type, "JSGW", Graduated in 5 ml interval with standard joint and sintered disc for measurement of air pollutants.

Cat. No.	Capacity ml.	Pore Size microns	Minimum Qty./Pack	Price/Piece (₹)
664/1	35	170-200	10	860.00
664/2	35	90-150	10	860.00
664/3	35	49-90	10	860.00

- 671 Calcium Chloride Tube, "JSGW", Straight or bent.

671/1	with one bulb	10	85.00
671/2	with two bulbs	10	95.00

- 672 Calcium Chloride Tube, "JSGW", U Shape

Cat. No.	Ht. x Tube O.D. mm. (approx.)	Minimum Qty./Pack	Price/Piece (₹)
672/1	100 x 12	10	155.00
672/2	125 x 15	10	165.00
672/3	150 x 18	10	205.00

- 673 Calcium Chloride Tube, "JSGW", U shape with side tube.

Cat. No.	Ht. x Tube O.D. mm. (approx.)	Minimum Qty./Pack	Price/Piece (₹)
673/1	100 x 12	10	230.00
673/2	125 x 15	10	255.00
673/3	150 x 18	10	275.00

- 674 Calcium Chloride Tube, "JSGW", U shape with side tube and I/C stopper.

Cat. No.	Ht. x Tube O.D. mm. (approx.)	Minimum Qty./Pack	Price/Piece (₹)
674/1	100 x 12	10	650.00
674/2	125 x 15	10	665.00
674/3	150 x 18	10	715.00

- 676 Absorption Bulbs, "JSGW"

Cat. No.	Type	Minimum Qty./Pack	Price/Piece (₹)
676/1	Nesbitt	10	725.00
676/2	Midvale	10	725.00

- 678 Calcium Chloride Tower, "JSGW", Tubular at bottom and stopcock at top.

Cat. No.	Body O.D. x Ht. mm. (approx.)	Minimum Qty./Pack	Price/Piece (₹)
678/1	38 x 250	10	1305.00
678/2	50 x 300	10	1585.00
678/3	60 x 300	10	2325.00

- 679 Tutwiler Gas Burette, "JSGW", for determination of hydrogen sulphide, with stopcock at top and bottom and only two graduation marks at 100 ml. and 110 ml. Complete with Cylindrical reservoir at top, graduation downward from 0-9 ml. 6645.00

- 680 Bunte Gas Burette, "JSGW", with stop-cocks at both ends, graduated 100 x 0.2 ml. 6645.00

- 681 Hample Gas Burette, "JSGW", with two way stopcock at top and three way stopcock at bottom, 100 x 0.2 ml. With levelling tube, without stand. 6645.00

- 684 Nitrometer Lunge's, "JSGW", 50 ml. x 0.1 ml. Graduated tube, with cup graduated 0 to 10 ml. with double oblique bore stopcock, complete with plain levelling bulb. 6150.00
- 685 – do – with stand and clamps. 7970.00
- 686 Nitrometer Schiff's, "JSGW", 100 x 0.2 ml. Graduated tube, stopcock and levelling bulb. 2490.00
- 687 – do – with stand and clamps. 4485.00
- 688 Gas Collecting Tubes, "JSGW", with two three way double oblique bore stopcocks one on each side.

Cat. No.	Capacity ml.	Minimum Qty./Pack	Price/Piece (₹)
688/1	15	4	1145.00
688/2	30	4	1160.00
688/3	70	4	1225.00
688/4	100	4	1270.00
688/5	250	4	1365.00
688/6	500	4	1995.00

- 689 Gas Collecting Tubes, "JSGW", with two three way double oblique bore, PTFE key stopcocks one on each side.

Cat. No.	Capacity ml.	Minimum Qty./Pack	Price/Piece (₹)
689/1	15	4	2990.00
689/2	30	4	3080.00
689/3	70	4	3080.00
689/4	100	4	3090.00
689/5	250	4	3155.00
689/6	500	4	3320.00

- 690 Gas Collecting Tubes, "JSGW", with two, two way stopcocks one on each side.

Cat. No.	Capacity ml.	Minimum Qty./Pack	Price/Piece (₹)
690/1	125	4	815.00
690/2	250	4	930.00
690/3	500	4	1190.00

- 690A Gas Collecting Tubes, "JSGW", with two, two way stopcocks one on each side, with side tube, screw cap and rubber septa.

Cat. No.	Capacity ml.	Minimum Qty./Pack	Price/Piece (₹)
690A/1	125	4	1160.00
690A/2	250	4	1280.00
690A/3	500	4	1540.00

- 691 Gas Collecting Tubes, "JSGW", with two, two way PTFE key stopcocks, one on each side

Cat. No.	Capacity ml.	Minimum Qty./Pack	Price/Piece (₹)
691/1	125	4	1645.00
691/2	250	4	1780.00
691/3	500	4	1945.00

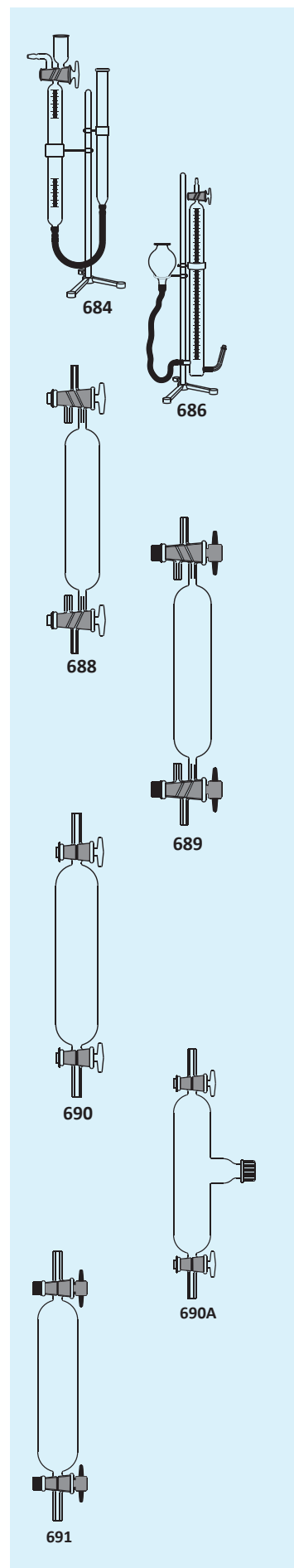

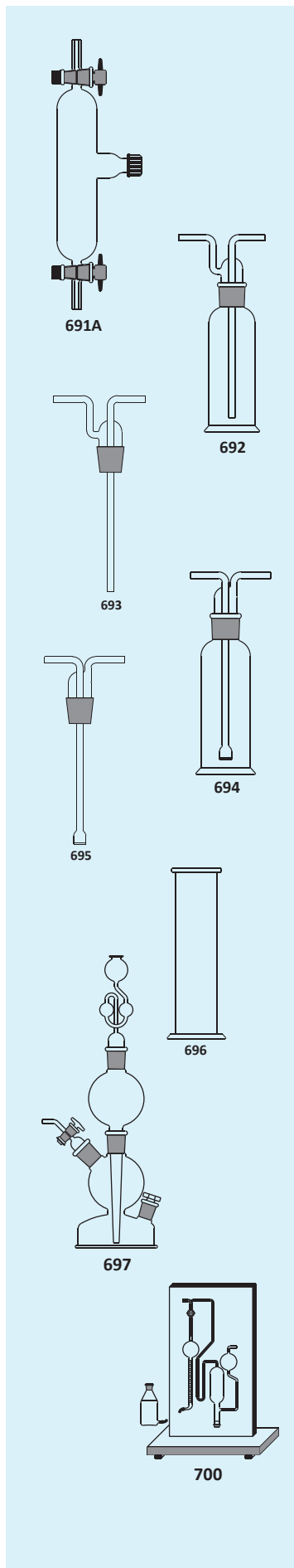

- 691A Gas Collecting Tubes, "JSGW", with two, two way PTFE key stopcocks, one on each side, with side tube screw cap and rubber septa.

Cat. No.	Capacity ml.	Minimum Qty./Pack	Price/Piece (₹)
691A/1	125	4	1995.00
691A/2	250	4	2075.00
691A/3	500	4	2295.00

- 692 Gas Washing Bottles, "JSGW", Dreshle's type, interchangeable joints.

Cat. No.	Capacity ml.	Minimum Qty./Pack	Price/Piece (₹)
692/1	125	4	975.00
692/2	250	4	1210.00
692/3	500	4	1430.00

- 693 Spare Head, for Gas Washing Bottles.

Cat. No.	Capacity ml.	Minimum Qty./Pack	Price/Piece (₹)
693/1	125	4	480.00
693/2	250	4	480.00
693/3	500	4	480.00

- 694 Gas Washing Bottles, "JSGW", with sintered disc, interchangeable joints.

Cat. No.	Capacity ml.	Minimum Qty./Pack	Price/Piece (₹)
694/1	125	4	1250.00
694/2	250	4	1470.00
694/3	500	4	1670.00

- 695 Spare Head, for Gas Wash Bottles with Sintered Disc.

Cat. No.	Capacity ml.	Minimum Qty./Pack	Price/Piece (₹)
695/1	125	4	815.00
695/2	250	4	815.00
695/3	500	4	815.00

- 696 Gas Jar, "JSGW", with ground Glass flat flange.

Cat. No.	Height mm. (approx.)	O.D. mm. (approx.)	Minimum Qty./Pack	Price/Piece (₹)
696/1	150	50	4	885.00
696/2	200	50	4	1050.00
696/3	200	75	4	1440.00
696/4	300	75	4	1715.00

- 697 Gas Generator - Kipp's, "JSGW", with interchangeable joints.

Cat. No.	Capacity ml.	Minimum Qty./Pack	Price/Piece (₹)
697/1	250	1	4160.00
697/2	500	1	5540.00
697/3	1000	1	7625.00
697/4	100	1	1905.00

- 700 Oxygen Determination Assembly, "JSGW", as per I.S. Specification, fitted on wooden stand.

701	Complete Glass Parts, for Cat. No. 700.	7475.00
702	Gas Burette, Only for Cat. No. 700.	3155.00

## ORSAT GAS ANALYSIS

- 705 Orsat Gas Analysis Unit**, with 3 absorption pipettes of two compartment type, 100ml Gas Burette with outer Jacket, manifold with Stopcocks & aspirator bottle, for the analysis of CO, O<sub>2</sub>, CO<sub>2</sub> particularly in fuel & furnace gases, complete in wooden cabinet with sliding doors. *The lower portion of burette graduated at 0.2ml upto 30ml & the remaining 70ml in 5ml Div.* **21180.00**
- 707 Orsat Gas Analysis Unit**, with 3 absorption pipettes of two compartment type, 100 ml Gas Burette with outer Jacket, manifold with **PTFE Stopcocks** & aspirator bottle, for the analysis of CO, O<sub>2</sub>, CO<sub>2</sub> particularly in fuel & furnace gases, complete in wooden cabinet with sliding doors. *The lower portion of burette graduated at 0.2ml upto 30ml & the remaining 70ml in 5ml Div.* **24940.00**
- 711 Orsat Gas Analysis Unit**, with 4 absorption pipettes of two compartment type, 100 ml Gas Burette with outer Jacket, manifold with Stopcocks & aspirator bottle, Palladium, asbestos tube, adjustable spirit lamp for the analysis of CO, CO<sub>2</sub>, H<sub>2</sub> and nitrogen (by difference) complete in wooden cabinet with sliding doors. *The lower portion of burette graduated at 0.2ml upto 30ml & the remaining 70ml in 5ml Div.* **25285.00**
- 713 Orsat Gas Analysis Unit**, with 4 absorption pipettes of two compartment type, 100 ml Gas Burette with outer Jacket, manifold with **PTFE Stopcocks** & aspirator bottle, Palladium, asbestos tube, adjustable spirit lamp for the analysis of CO, CO<sub>2</sub>, H<sub>2</sub> and nitrogen (by difference) complete in wooden cabinet with sliding doors. *The lower portion of burette graduated at 0.2ml upto 30ml & the remaining 70ml in 5ml Div.* **29655.00**
- 714 Orsat Gas Analysis Unit**, with 5 absorption pipettes for determining CO<sub>2</sub>, CO, H<sub>2</sub> illuminants methane, ethane & nitrogen (by difference). There are four absorption pipettes, of which two of the two compartments type filled with glass tubes to increase absorption area and two bubbling type with three way stopcock and one slow combustion pipette with platinum wire coil, & rheostat to operate on 220 volts, complete in wooden cabinet with sliding doors. *The lower portion of burette graduated at 0.2ml upto 30ml & the remaining 70ml in 5ml Div.* **33660.00**
- 716 Orsat Gas Analysis Unit**, with 5 absorption pipettes for determining CO<sub>2</sub>, CO, H<sub>2</sub> illuminants methane, ethane & nitrogen (by difference). There are four absorption pipettes, of which two of the two compartments type filled with glass tubes to increase absorption area and two bubbling type with three way **PTFE Stopcock** and one slow combustion pipette with platinum wire coil, & rheostat to operate on 220 volts, complete in wooden cabinet with sliding doors. *The lower portion of burette graduated at 0.2ml upto 30ml & the remaining 70ml in 5ml Div.* **38230.00**

### 720 Spares of Orsat Gas Analysis.

Cat. No.	Item	Price/Piece (₹)
720/1*	100 ml. burette only	1025.00
720/2	Water Jacket with Rubber Corks	695.00
720/3	Absorption pipette filled with tubes	945.00
720/3A	Absorption pipette filled with tubes with copper wire	1330.00
720/4	Bubbler pipette with three way stopcock	1530.00
720/4A	Bubbler pipette with PTFE three way stopcock	2325.00
720/5	Slow combustion pipette	5275.00
720/6	Manifold for Cat. No. 705	1600.00
720/7	Manifold for Cat. No. 707	4905.00
720/8	Manifold for Cat. No. 711	1975.00
720/9	Manifold for Cat. No. 713	5240.00
720/10	Manifold for Cat. No. 714	1865.00
720/11	Manifold for Cat. No. 716	4905.00
720/14	U Tube fitted with glass wool	630.00
720/15	Levelling bottle 250 ml.	665.00
720/16	Palladium Asbestos Tube	1365.00

\* The lower portion of burette graduated at 0.2ml upto 30ml & the remaining 70ml in 5ml Div.

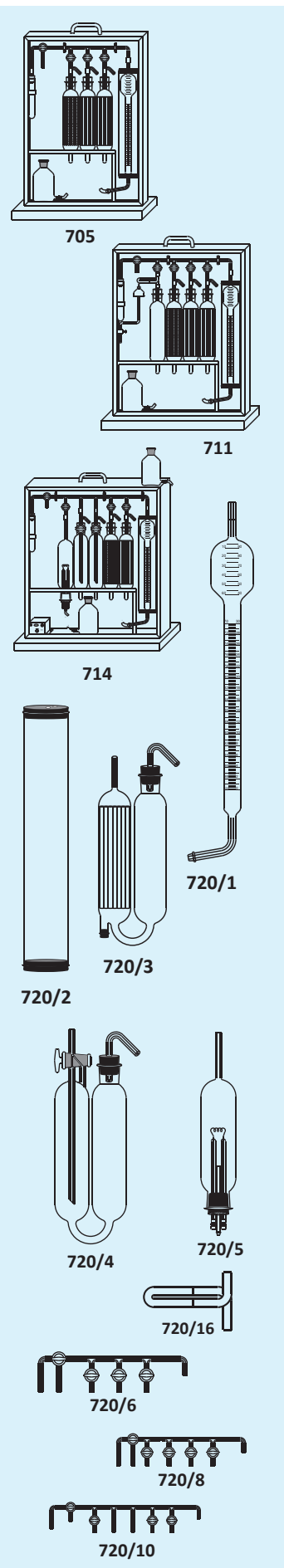

## MANOMETER

756	Manometer, U tube mounted on wooden stand with scale 250-0-250 mm. without mercury.	1500.00
757	Same as Cat. No. 756 with scale 120-0-120 mm.	1330.00
758	Vacustat Gauge, Modified form of McLeod gauges, Range 10 mm to 0.01 mm. Hg. Pressure.	16500.00

## ELECTRODES GLASSWARE

770	Hoffman's Voltmeter, "JSGW", to demonstrate that H <sub>2</sub> O consists of two volumes of Hydrogen and one volume of Oxygen with 50 ml. Graduated limbs with stopcocks, central limb with reservoir and removable platinum electrodes.	1850.00
771	– do – with 25 ml. graduated limbs.	1655.00
772	Spare Platinum Electrodes Pair for Hoffman's Voltmeter.	670.00
785	Transport Number, Determination Unit, "JSGW", Findly U form with silver electrodes.	3080.00
788	Calomel Potential Vessel "JSGW" Ordinary	420.00
789	Calomel Potential Vessel, "JSGW", with stopcock and side tube.	700.00
790	Calomel Electrode Vessel, "JSGW", Ordinary, Plain with rubber connected side tube.	420.00

### 791 Calomel Electrodes, "JSGW".

Cat. No.	Description	Price/Piece (₹)
791/1	With Platinum foil of 8 mm square	1745.00
791/2	With Platinum foil of 4 mm square	1040.00
791/3	With Silver foil of 8 mm square	420.00
791/4	With Silver foil of 4 mm square	345.00
791/5	With Platinum Wire of 10 mm length	570.00
791/6	With Platinum Wire of 20 mm length	930.00
791/7	With Silver Wire and Copper Wire connected	300.00

793	pH Meter combined electrode, glass round.	1780.00
-----	---	---------

## MOLECULAR WEIGHT GLASS PRODUCTS

811	Beckmann's Depression of Freezing Point, "JSGW", for the determination of molecular Weight, Comprising of 2 litre glass cooling jar, cover, two stirrers, air jacket, freezing tube fitted with cork, glass syphon, but without thermometers.	7845.00
814	Cottrel Crown, "JSGW", Boiling point apparatus.	3650.00
815	Molecular Weight Determination, "JSGW", McCoy's, ground glass fittings	1995.00
817	Molecular Weight Determination, "JSGW", (Land Berger's) Boiling point method, modified by Walker and Lunsden without wall thermometer	1830.00
818	Vapour Density, Victor Meyer's Apparatus.	1995.00
819	Spare Inner Tube, "JSGW", only for Victor Meyer's App.	585.00
820	Victor Meyer's Apparatus, "JSGW", with copper Jacket and inner glass tube.	6980.00

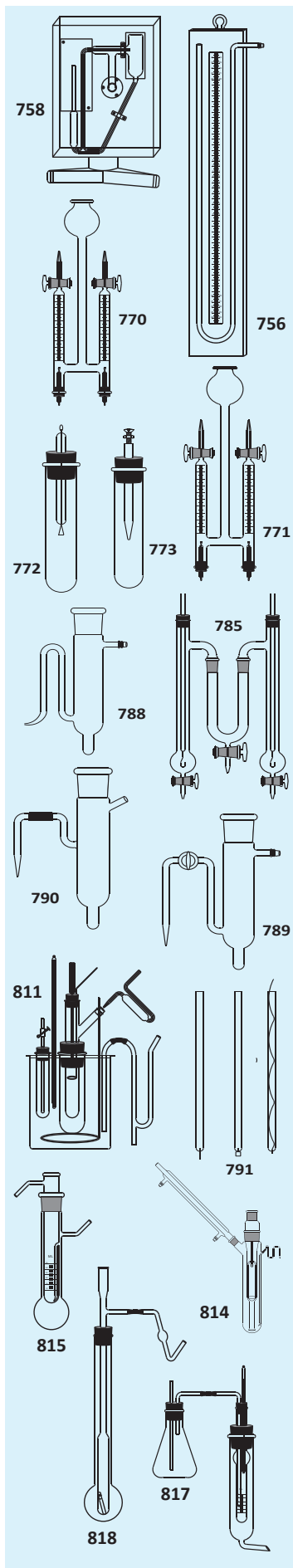

## MISCELLANEOUS GLASSWARE

825	Dissolution Bowl, Clear Glass, with Graduation, "JSGW"	3650.00
826	Dissolution Bowl, Amber Glass, with Graduation, "JSGW"	7205.00
830	Sampling Tube (Dip Tube) 105 cm long, Dia 19 mm, Heavywall	975.00
831	Schoinger Micro Combustion Flask, "JSGW", (Oxygen Flask) 500 ml with Platinum wire gauge sample carrier, for determination of Halogens, Sulphur, Phosphorous metal etc.	84000.00
832	Schoinger Micro Combustion Flask, "JSGW", (Oxygen Flask) 1000 ml with Platinum wire gauge sample carrier, for determination of Halogens, Sulphur, Phosphorous metal etc.	85000.00

### 834 Dishes Crystallizing "JSGW"

Cat. No.	Approx. O.D. x Ht. mm.	Approx. Capacity ml.	Minimum Qty./Pack	Price/Piece (₹)
834/4	70 x 40	100	10	320.00
834/5	80 x 45	150	10	420.00
834/7	100 x 50	300	10	600.00
834/10	150 x 75	1000	5	1415.00
834/11	190 x 100	2000	5	2250.00

### 835 Dishes Evaporating, Flat Bottom, with Spout, "JSGW"

Cat. No.	Approx. O.D. x Ht. mm.	Approx. Capacity ml.	Minimum Qty./Pack	Price/Piece (₹)
835/4	80 x 45	90	10	450.00
835/6	105 x 55	180	10	610.00
835/8	150 x 80	650	10	1430.00
835/10	200 x 100	1600	5	2785.00

### 836 Kjeldahl bulb, "JSGW", connecting, sloping, single.

Cat. No.	Bulb O.D. mm.	Tube O.D. mm.	Price/Piece (₹)
836/1	50	10	270.00
836/2	65	10	340.00

### 837 Kjeldahl bulb, "JSGW", connecting, Vertical

838 – do – with two bulbs, "JSGW". 380.00

839 Particle Size Determination Pipette "JSGW", (Sedimentation Pipette, Anderson) consisting of 500 ml. graduated Cylinder, graduation from 0 to 20 cm. and fitted with 10 ml. Pipette with three way stopcock, the tip of Pipette at the level of 0 mark at the Cylinder scale. 3810.00

### 840 Dirt Correction, "JSGW", 1000 ml with stopcock.

840/1	Plain	2970.00
840/2	Graduated	3455.00

### 845 Wash Bottles, "JSGW", with interchangeable joints.

Cat. No.	Capacity ml.	Joint Size mm	Minimum Qty./Pack	Price/Piece (₹)
845/1	250	24/29	6	830.00
845/2	500	24/29	6	975.00
845/3	1000	29/32	6	1305.00

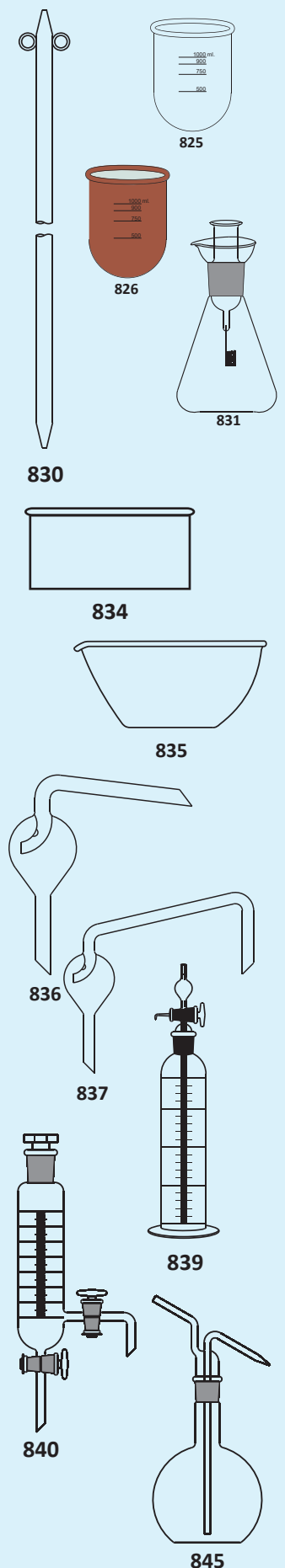

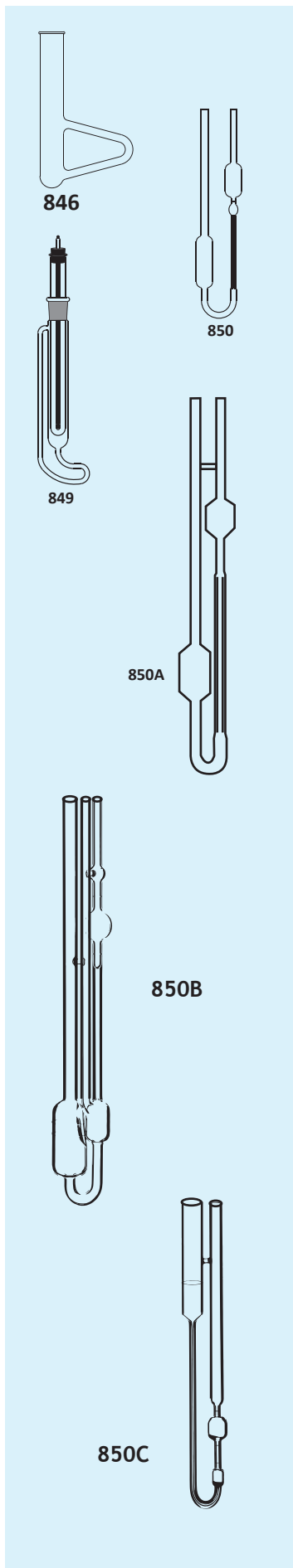

**846 Thiele's Melting Point Tubes, "JSGW".**

Cat. No.	Size mm.	M. Qty/Pack	Price/Piece (₹)
846/1	150 x 18	6	140.00
846/2	150 x 25	6	175.00

**849 Melting Point Apparatus, "JSGW", (Junge's) with standard joint fittings, without Thermometer**

1415.00

**850 Viscometer, "JSGW", Ostwald, standard size, College Pattern, Centre support.**

325.00

850/1	— do —	80-100 Sec.	2	410.00
850/2	— do —	100-120 Sec.	2	410.00

**850A Viscometer, "JSGW", U-Tube as per BS/U and ASTM D446 for Transparent Liquids with Calibration Certificate at 20°C.**

Cat. No.	Size	Nominal Constant	Viscosity Range	Minimum Qty/Pack	Price/Piece (₹)
850A/1	0	0.001		1	11430.00
850A/2	A	0.003	0.9-3	1	11225.00
850A/3	B	0.01	2-10	1	11225.00
850A/4	C	0.03	6-30	1	11225.00
850A/5	D	0.1	20-100	1	11225.00
850A/6	E	0.3	60-300	1	11225.00
850A/7	F	1	200-1000	1	11225.00
850A/8	G	3	600-3000	1	11225.00
850A/9	H	10	2000-10000	1	11225.00

**850B Viscometer, "JSGW", Suspended Level as per BS/IP and ASTM D446 with Calibration Certificate at 20°C.**

Cat. No.	Size	Nominal Constant	Viscosity Range	Minimum Qty/Pack	Price/Piece (₹)
850B/1	1	0.01	3.5-10	1	11790.00
850B/2	1A	0.03	6.0-30	1	11790.00
850B/3	2	0.1	20-100	1	11790.00
850B/4	2A	0.3	60-300	1	11790.00
850B/5	3	1	200-1000	1	11790.00
850B/6	3A	3	600-3000	1	11790.00
850B/7	4	10	2000-10000	1	11790.00
850B/8	4A	30	6000-30000	1	11790.00

**850C Viscometer, "JSGW", U-Tube, Reverse Flow for Opaque liquids as per BS/IP and ASTM D446 with Calibration Certificate at 20°C.**

Cat. No.	Size	Nominal Constant	Viscosity Range	Minimum Qty/Pack	Price/Piece (₹)
850C/1	1	0.003	0.6-3	1	11225.00
850C/2	2	0.01	2-10	1	11225.00
850C/3	3	0.03	6-30	1	11225.00
850C/4	4	0.1	20-100	1	11225.00
850C/5	5	0.3	60-300	1	11225.00
850C/6	6	1	200-1000	1	11225.00
850C/7	7	3	600-3000	1	11225.00
850C/8	8	10	2000-10000	1	11225.00
850C/9	9	30	6000-30000	1	11225.00

**850D** Viscometer, “JSGW”, Cannon-Fenske Direct Flow for Transparent Liquid as per BS/IP and ASTM D446 with Calibration Certificate at 20°C.

Cat. No.	Size	Nominal Constant	Viscosity Range	Minimum Qty/Pack	Price/Piece (₹)
850D/1	25	0.002	0.5-2	1	11225.00
850D/2	50	0.004	0.8-4	1	11225.00
850D/3	75	0.008	1.6-8	1	11225.00
850D/4	100	0.015	3-15	1	11225.00
850D/5	150	0.035	7-35	1	11225.00
850D/6	200	0.1	20-100	1	11225.00
850D/7	300	0.25	50-250	1	11225.00
850D/8	350	0.5	100-500	1	11225.00
850D/9	400	1.2	240-1200	1	11225.00
850D/10	450	2.5	500-2500	1	11225.00
850D/11	500	8	1600-8000	1	11225.00
850D/12	600	20	4000-20000	1	11225.00

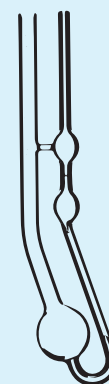

850D

**850F** Viscometer, “JSGW”, Cannon-Fenske Reverse Flow for Transparent Liquid as per BS/IP and ASTM D446 with Calibration Certificate at 20°C.

Cat. No.	Size	Nominal Constant	Viscosity Range	Minimum Qty/Pack	Price/Piece (₹)
850F/1	25	0.002	0.4-2	1	12350.00
850F/2	50	0.004	0.8-4	1	11505.00
850F/3	75	0.008	1.6-8	1	11505.00
850F/4	100	0.015	3-15	1	11505.00
850F/5	150	0.035	7-35	1	11505.00
850F/6	200	0.1	20-100	1	11505.00
850F/7	300	0.25	50-200	1	11505.00
850F/8	350	0.5	100-500	1	11505.00
850F/9	400	1.2	240-1200	1	11505.00
850F/10	450	2.5	500-2500	1	11505.00
850F/11	500	8	1600-8000	1	11505.00
850F/12	600	20	4000-20000	1	11505.00



850F

**850G** Viscometer, “JSGW”, Ubbelohde for Transparent Liquids as per ASTM D446 with Calibration Certificate at 20°C.

Cat. No.	Size	Nominal Constant	Viscosity Range	Minimum Qty/Pack	Price/Piece (₹)
850G/1	0	0.001	0.3-1	1	12350.00
850G/2	0C	0.003	0.6-3	1	11225.00
850G/3	0B	0.005	1-5	1	11225.00
850G/4	1	0.01	2-10	1	11225.00
850G/5	1C	0.03	6-30	1	11225.00
850G/6	1B	0.05	10-50	1	11225.00
850G/7	2	0.1	20-100	1	11225.00
850G/8	2C	0.3	60-300	1	11225.00
850G/9	2B	0.5	100-500	1	11225.00
850G/10	3	1.0	200-1000	1	11225.00
850G/11	3C	3.0	600-3000	1	11225.00
850G/12	3B	5.0	1000-5000	1	11225.00
850G/13	4	10	2000-10000	1	11225.00
850G/14	4C	30	6000-30000	1	11225.00



850G

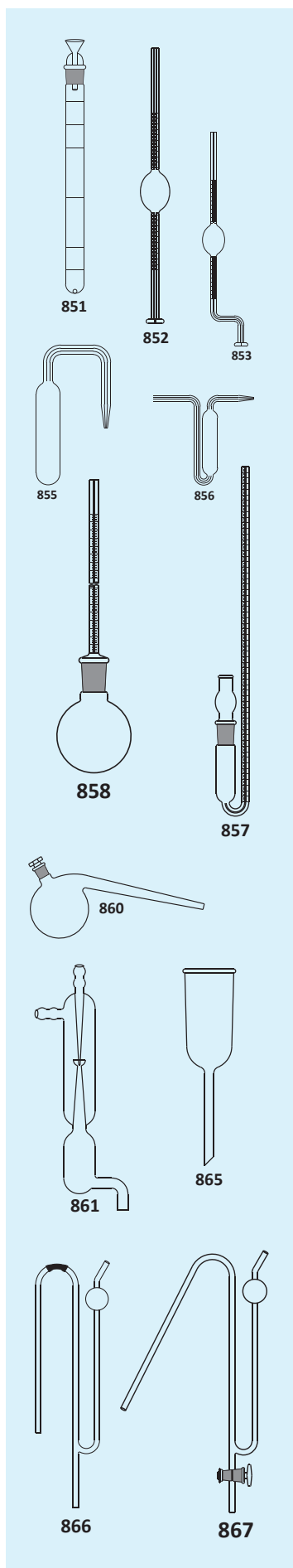

851 Viscometer, "JSGW", Falling sphere type, standard joint fitting.

Cat. No.	O.D. of Tube mm.	Minimum Qty/Pack	Price/Piece (₹)
851/1	25	2	720.00
851/2	40	2	855.00

852 Stalganometer, "JSGW" Straight, graduated 210.00

852A Stalganometer, "JSGW" Straight, graduated with Rota Flow Stopcock 430.00

853 Stalganometer, "JSGW", Bent, graduated 230.00

854 Stalganometer, "JSGW", Set of Three (one straight, two bent) 1125.00

855 Weight Thermometers "JSGW"

Cat. No.	Capacity ml.	Minimum Qty/Pack	Price/Piece (₹)
855/1	5	10	105.00
855/2	10	10	110.00
855/3	25	10	150.00

856 Pyknometers, "JSGW"

Cat. No.	Capacity ml.	Minimum Qty/Pack	Price/Piece (₹)
856/1	5	10	155.00
856/2	10	10	170.00
856/3	25	10	220.00

857 Dilatometer, "JSGW", Designed for measuring the expansion of edible oil and fats, over the temperature range during melting. The ratio of solid to liquid present can be obtained. 905.00

858 Dilatometer, "JSGW", consists of 50 ml. flask with 30 cm long graduated capillary of 1 mm bore with standard 14/23 joint fitting. 580.00

860 Retorts, "JSGW", with interchangeable stopper.

Cat. No.	Capacity ml.	Minimum Qty/Pack	Price/Piece (₹)
860/1	100	2	555.00
860/2	150	2	590.00
860/3	250	2	655.00
860/4	500	2	880.00

861 Filter Pump, "JSGW", University pattern. 325.00

862 – do – superior quality 415.00

863 Filter Pump, "JSGW", Edward's type heavy pattern, Brass. 1325.00

865 Adapter, "JSGW", for Gooch Crucible.

Cat. No.	I.D. x Ht. mm.	Stem (mm) Lt. x O.D.	Suitable for Crucible (ml.)	Price/Piece (₹)
865/1	31 x 60	75 x 9	15	140.00
865/2	40 x 68	75 x 9	30	150.00
865/3	47 x 78	75 x 9	50	195.00

866 Syphon, "JSGW", with suction tube 18" long. 860.00

867 – do – with suction tube and stopcock 18" long, "JSGW". 1370.00

868 Funnel Filtering, "JSGW", 60° angle with stem.

Cat. No.	Diameter mm.	Minimum Qty/Pack	Price/Piece (₹)
868/1	25	12	80.00
868/2	38	12	85.00
868/3	50	12	95.00
868/4	65	12	115.00
868/5	75	12	135.00
868/6	100	12	200.00
868/7	125	12	425.00

868A Funnel-Powder, Short Plain Stem "JSGW"

Cat. No.	Diameter mm.	Minimum Qty/Pack	Price/Piece (₹)
868A/3	55	4	160.00
868A/5	80	4	220.00
868A/6	100	4	340.00
868A/7	125	4	570.00
868A/8	150	4	1105.00
868A/9	200	4	2615.00

868B Powder Funnel with 24/29 cone at stem "JSGW"

868B/11	100	4	425.00
868B/12	125	4	660.00
868B/13	150	4	1145.00

869 Thistle Funnel, "JSGW", 30 cm stem 180.00

870 Thistle Funnel for Kipp's apparatus, "JSGW" 230.00

871 Polarimeter Tubes, "JSGW", with Centre Bulb, screw caps and cover glasses.

Cat. No.	Length mm.	Minimum Qty/Pack	Price/Piece (₹)
871/1	100	2	1845.00
871/2	200	2	1900.00
871/4	400	2	1960.00

872 Polarimeter Tubes, "JSGW", with Centre Cup, screw caps and cover glasses.

Cat. No.	Length mm.	Minimum Qty/Pack	Price/Piece (₹)
872/1	100	2	1900.00
872/2	200	2	1930.00
872/4	400	2	1975.00

873 Dewar Flask, "JSGW", Double walled, cylindrical, evacuated, unsilvered.

Cat. No.	Inner Tube mm.	Approx. Cap. ml.	Minimum Qty/Pack	Price/Piece (₹)
873/1	50 x 200	300	1	3305.00
873/2	50 x 250	400	1	3645.00
873/3	60 x 200	475	1	4035.00
873/4	60 x 250	600	1	4120.00
873/5	75 x 200	750	1	5405.00
873/6	75 x 250	950	1	6040.00
873/7	100 x 300	2000	1	9795.00

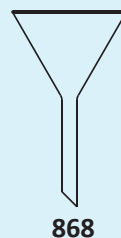

868

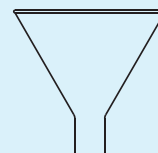

868A

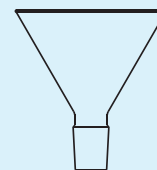

868B

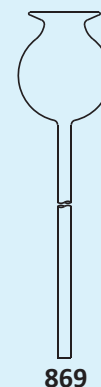

869

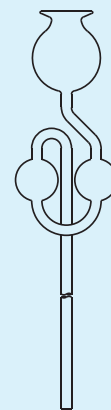

870

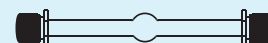

871



872



873

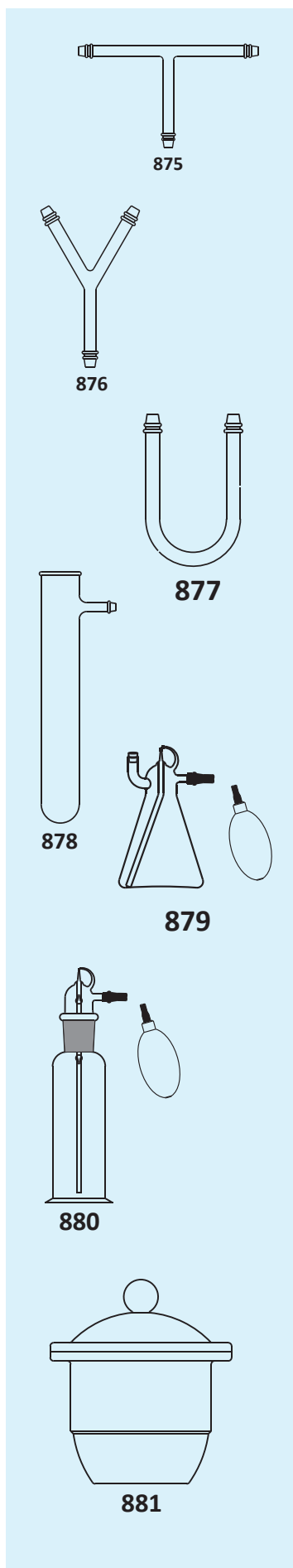

**875** Connection Tubes, "JSGW", T shape.

Cat. No.	Tube dia. mm.	Minimum Qty/Pack	Price/Piece (₹)
875/1	7	10	90.00
875/2	10	10	105.00
875/3	12	10	125.00

**876** Connection Tubes, "JSGW", Y shape.

Cat. No.	Tube dia. mm.	Minimum Qty/Pack	Price/Piece (₹)
876/1	7	10	90.00
876/2	10	10	105.00
876/3	12	10	125.00

**877** Connection Tubes, "JSGW", U shape.

Cat. No.	Tube dia. mm.	Minimum Qty/Pack	Price/Piece (₹)
877/1	7	10	85.00
877/2	10	10	95.00
877/3	12	10	115.00

**878** Filter Tubes, "JSGW", with side tube.

Cat. No.	Tube Size mm.	Minimum Qty/Pack	Price/Piece (₹)
878/1	100 x 12	10	60.00
878/2	125 x 15	10	65.00
878/3	150 x 18	10	85.00
878/4	150 x 25	10	105.00

**879** Chromatography Sprayers, "JSGW", with rubber bellow.

Cat. No.	Capacity ml.	Minimum Qty/Pack	Price/Piece (₹)
879/1	100	6	800.00
879/2	150	6	830.00
879/3	250	6	860.00

**880** Chromatography Sprayers, "JSGW", Bottle type with interchangeable joints, rubber bellow.

Cat. No.	Capacity ml.	Minimum Qty/Pack	Price/Piece (₹)
880/1	25	6	880.00
880/2	50	6	925.00
880/3	100	6	995.00

**880A** Chromatography Sprayers, "JSGW", Tapper type with interchangeable joints, rubber bellow.

Cat. No.	Capacity ml.	Minimum Qty/Pack	Price/Piece (₹)
880A/1	25	6	920.00
880A/2	50	6	995.00

**881** Dessicator Plain with knobbed lid, Ground Flanges Neutral Glass, with Perforated Porcelain Plate.

Cat. No.	Dia. mm.	Minimum Qty/Pack	Price/Piece (₹)
881/1	160	1	3005.00
881/2	210	1	55090.00
881/3	240	1	7710.00
881/4	300	1	11140.00
881/5	120	1	2185.00

**881A Dessicator Plain, Amber Colour, with knobbed lid, Ground Flangers, Neutral Glass with Perforated Porcelain Plate.**

Cat. No.	Dia. mm.	Minimum Qty/Pack	Price/Piece (₹)
881A/1	160	1	4165.00
881A/2	210	1	7355.00
881A/3	240	1	11235.00
881A/4	300	1	16745.00

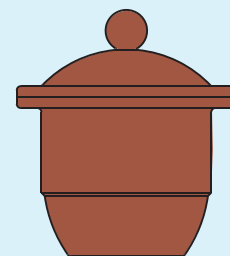

881A

**882 Dessicator, Vacuum with tubular Lid, Ground Flanges with stopcock made of Neutral glass, supplied with Perforated Porcelain Plate.**

Cat. No.	Dia. mm.	Minimum Qty/Pack	Price/Piece (₹)
882/1	160	1	3625.00
882/2	210	1	7185.00
882/3	240	1	11135.00
882/4	300	1	15510.00

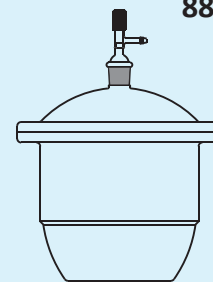

882

**883 Specimen Jars, "JSGW", with bakelite screw cap, suitable for Culture, Autoclaveable.**

Cat. No.	O.D. x Ht. mm.	Approx. Cap. ml.	Minimum Qty/Pack	Price/Piece (₹)
883/1	50 x 75	100	10	390.00
883/2	60 x 110	250	10	555.00
883/3	75 x 130	500	10	785.00
883/4	90 x 185	1000	5	1175.00



883

**884 Weighing Scoops, "JSGW", with open tubular arm.**

Cat. No.	Capacity ml	Minimum Qty/Pack	Price/Piece (₹)
884/1	1	10	295.00
884/2	3	10	295.00
884/3	6	10	315.00
884/4	10	10	325.00
884/5	2	10	295.00
884/6	0.5	10	295.00

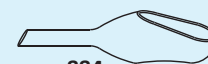

884



885

**885 Spatula Ended Spoon, "JSGW" 140.00**

**886 Kjeldahl Digestion Tubes, "JSGW", with constriction on top.**

Cat. No.	O.D. x Length mm.	Minimum Qty/Pack	Price/Piece (₹)
886/1	24 x 250	6	315.00
886/2	26 x 250	6	325.00
886/3	40 x 300	6	470.00



886

**887 Kjeldahl Digestion Tube with Collar**

Cat. No.	O.D. x Length mm	Minimum Qty/Pack	Price/Piece (₹)
887/1	40x300 mm	6	460.00
887/2	42x300 mm	6	470.00
887/3	26x300 mm	6	325.00



887

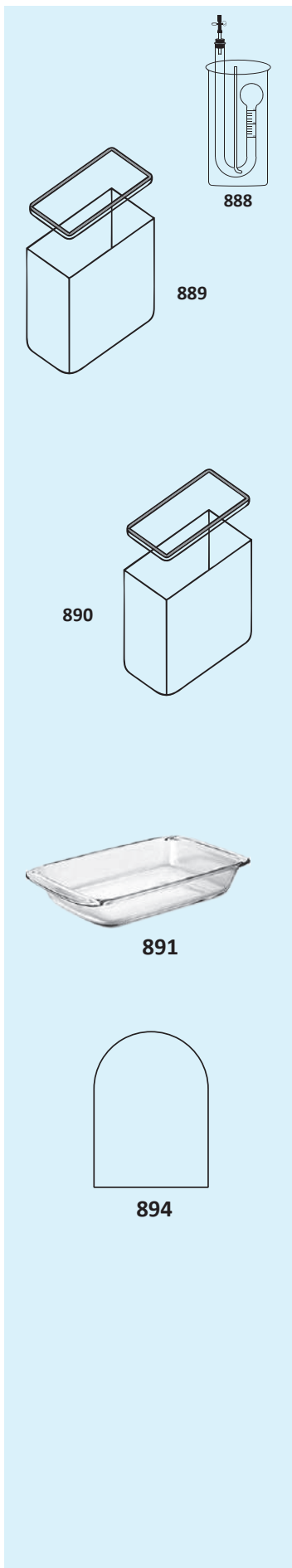

888 Charles's Law Apparatus, "JSGW", with one litre tall form beaker & graduated 3 limb tube with bulb, pinch cock & rubber tube. 1960.00

889 Jars, Rectangular, Museum, made of Borosilicate 3.3 Exp. glass with glass cover.

Cat. No.	Height mm.	Length mm.	Breadth mm.	Minimum Qty/Pack	Price/Piece (₹)
889/1	200	125	125	1	8875.00
889/2	200	150	100	1	9440.00
889/3	220	195	80	1	10455.00
889/4	250	165	140	1	10990.00
889/5	250	250	120	1	13180.00
889/6	360	150	100	1	22080.00

890 Jars, Rectangular, Museum, Neutral glass with glass cover.

Cat. No.	Height mm.	Length mm.	Breadth mm.	Minimum Qty/Pack	Price/Piece (₹)
890/1	140	215	100	2	2560.00
890/2	210	170	130	2	2780.00
890/3	225	225	125	2	3515.00
890/4	250	250	150	2	5280.00
890/5	220	140	140	2	2715.00
890/6	360	150	100	2	6285.00
890/7	380	280	230	2	13405.00

891 Trays, Drying, Heavy Wall, for withstanding Hot air or steam sterilization. Simplifies paper chromatography, made from 3.3 Borosilicate glass.

Cat. No.	Inner Dimn. L x B x H (mm)	Approx Capacity (ml)	Minimum Qty/Pack	Price/Piece (₹)
891/1	220 x 135 x 40	1000	1	675.00
891/2	260 x 165 x 45	1600	1	795.00
891/3	307 x 190 x 50	2200	1	1090.00
891/5	350 x 225 x 50	3000	1	1520.00

894 Jars-Bell, Round Bottom, Edge Ground "JSGW".

Cat. No.	O.D. x Height mm. (approx.)	Minimum Qty/Pack	Price/Piece (₹)
894/1	300x450	1	28820.00
894/2	300x400	1	23590.00
894/3	200x350	1	18460.00

898 Kettles-Resin Reaction "JSGW".

Cat. No.	Capacity ml	Minimum Qty/Pack	Price/Piece (₹)
898/1	500	1	14910.00
898/2	1000	1	15775.00
898/3	2000	1	19415.00
898/4	4000	1	23670.00

## ARSENIC DETERMINATION APPARATUS

Cat. No.	Minimum Qty/Pack	Price/Piece (₹)
901	2	665.00
902	2	1115.00
903	2	1995.00
904	2	4650.00
905	2	3080.00
906	2	2580.00
907	2	2415.00
908	2	2415.00
909	2	2415.00

## CARBON, SULPHUR DETERMINATION GLASS PARTS

- 911 Absorption Vessel, "JSGW", with 3 valves, for KOH. 4985.00  
 912 Carbon Burettes Double Walled, "JSGW", Inner tube permanently graduated, with one valve at the top.

Cat. No.	Size %	Price/Piece (₹)
912/3	1.5	4940.00
912/4	4.5	5150.00

915	Sulphur Burette, "JSGW", 4 ml. with automatic zero, three way double oblique bore stopcock at the bottom.	1455.00
916	Stopcock, "JSGW" Three way, C bore, T shape.	1220.00
917	Stopcock, "JSGW", L Shaped, Long Glass Tube, Twin Bore stopper.	1220.00
918	Spiral Cooling Condenser, "JSGW"	790.00
919	Automatic Pipette, "JSGW", 15 ml.	695.00
920	Automatic Pipette, "JSGW", 10 ml.	630.00
921	Titration Vessel, "JSGW", 100 ml.	1570.00
922	Oxygen Purifying Assembly, "JSGW"	830.00
923	Aspirator Bottle (Levelling Bottle) for Carbon Burette, 1000 ml.	1270.00
924	Same as Cat. No. 923 long form.	1665.00
925	View Bulb, "JSGW", for combustion tube.	105.00

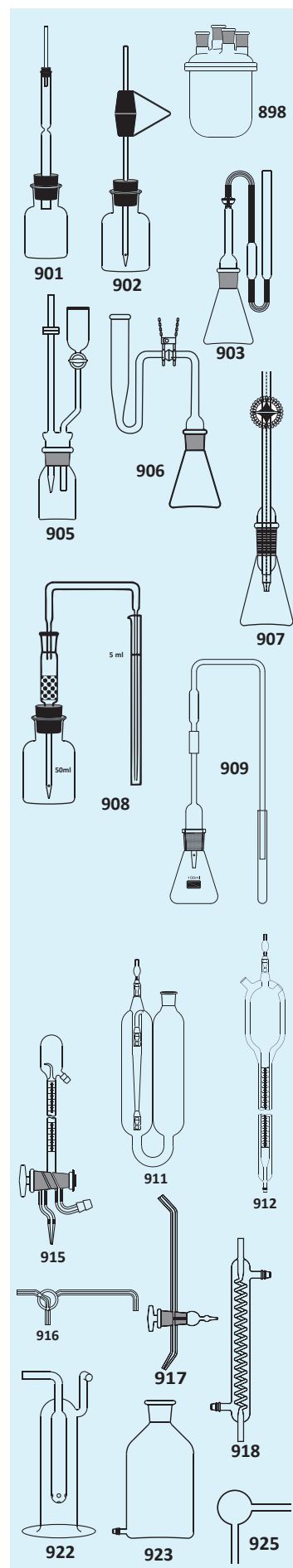

## DAIRY & MILK TESTING APPARATUS

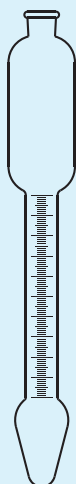

951

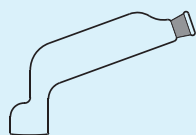

957

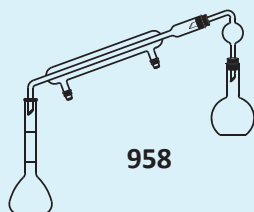

958

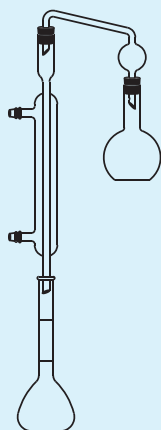

960

951	Butyrometer with plain neck with stem 10% Dr. Gerber's Design.	190.00
951N	Butyrometer with plain neck with stem 10% Dr. Gerber's Design. with <b>NABL</b> Certificate.	920.00
951A	Butyrometer with plain neck with stem 10% Dr. Gerber's Design. Double tested.	225.00
952	Butyrometer ISI marked.	190.00
953	Butyrometer Butter Grade 0-90% with cup and rubber stopper weighing type.	1445.00
953N	Butyrometer Butter Grade 0-90% with cup and rubber stopper weighing type with <b>NABL</b> Certificate.	2175.00
953/1	Butyrometer Butter, Milk Powder, Grade 0-35% with cup and rubber stopper, weighing type.	1445.00
953/1N	Butyrometer Butter, Milk Powder, Grade 0-35% with cup and rubber stopper, weighing type with <b>NABL</b> Certificate.	2175.00
954	Butyrometer Cream 0-70% weighing type as per ISI specifications.	1345.00
954N	Butyrometer Cream 0-70% weighing type as per ISI specifications with <b>NABL</b> Certificate.	2075.00
954/1	Butyrometer Cream 0-70% Volumetric Method as per ISI specs.	1345.00
954/1N	Butyrometer Cream 0-70% Volumetric Method as per ISI with <b>NABL</b> Certificate.	2075.00
954/2	Butyrometer Ice Cream, 0-20% Volumetric Method as per ISI.	1345.00
954/2N	Butyrometer Ice Cream, 0-20% Volumetric Method as per ISI with <b>NABL</b> Certificate.	2075.00
954/3	Butyrometer Cheese, 0-40% Volumetric Method as per ISI.	1345.00
954/3N	Butyrometer Cheese, 0-40% Volumetric Method as per ISI with <b>NABL</b> Certificate.	2075.00
954/4	Butyrometer Chocolate, 0-20% Volumetric Method as per ISI.	1345.00
954/4N	Butyrometer Chocolate, 0-20% Volumetric Method as per ISI with <b>NABL</b> Certificate.	2075.00
955	Butyrometer Skim Milk 0-0.5%	1345.00
955N	Butyrometer Skim Milk 0-0.5% with <b>NABL</b> Certificate.	2075.00
956	Lock Stopper for Butyrometer	28.00
956/1	SS Key for Butyrometer stopper	260.00
957	<b>Mojjonier</b> Flask as per ISI specifications, with Silicone Stopper	850.00
957A	Silicon Cork for Mojjonier Flask.	100.00
957S	<b>Mojjonier</b> Flask, Stand made from perpex sheet for 10 Pcs.	7700.00
958	<b>Reichert Wollney's Apparatus, "JSGW"</b> , for the determination of volatile fatty acids in margarine and butter, with rubber cork fitting without stand and burner.	1640.00
959	Same as Cat. No. 958 with standard joint fitting.	2125.00
960	<b>Polenske's Apparatus, (R.M. Value Apparatus), "JSGW"</b> , for the determination of butter fat and analysis of oil, fats, waxes with rubber cork fitting.	1640.00
960S	Stand for R.M. Value Apparatus.	1655.00
961	Same as Cat. No. 960 with standard joint fitting.	2285.00
962	Flask flat bottom 300 ml for cat no. 958 & 960	180.00
963	Flask Flat bottom 300 ml with 24/29 socket for cat no. 959 & 961	280.00
964	Condenser for Polenske's Apparatus or Reichert Wollney's Apparatus, <b>"JSGW"</b> .	630.00
965	Same as Cat. No. 964 with 24/29 socket.	680.00
966	Still head for Cat. No. 958 or 960	290.00
967	Still Head for Cat. No. 959 & 961 with standard joints.	485.00
968	Flask standard 100-110 marked, <b>"JSGW"</b> .	420.00

## THERMOMETERS

**971** Chemical Thermometers, "JSGW", Mercury Filled 30 cm. long, accuracy  $\pm 1$  division, made from Imported Capillary, Screen Printed Graduation.

Cat. No.	Range	Division	Price/Pcs. (₹)
971/1	0-50°C	1/1	450.00
971/2	0-50°C	1/2	450.00
971/3	0-100°C	1/1	410.00
971/4	-10-110°C	1/1	410.00
971/5	-10-110°C	1/2	410.00
971/6	0-150°C	1/1	410.00
971/7	0-200°C	1/1	410.00
971/8	0-250°C	1/1	410.00
971/9	0-300°C	2/1	410.00
971/10	0-360°C	2/1	410.00
971/11	0-220°F	1/1	410.00

**971N** Chemical Thermometers, "JSGW", Mercury Filled 30 cm. long, accuracy  $\pm 1$  division, made from Capillary, Screen Printed Graduation with NABL Certificate.

Cat. No.	Range	Division	Price/Pcs. (₹)
971N/1	0-50°C	1/1	1110.00
971N/2	0-50°C	1/2	1110.00
971N/3	0-100°C	1/1	1110.00
971N/4	-10-110°C	1/1	1110.00
971N/5	-10-110°C	1/2	1110.00
971N/6	0-150°C	1/1	1110.00

**971A** Chemical Thermometer "JSGW" Red spirit filled 30cm long made from imported capillary, Screen Printed Graduation.

Cat. No.	Range	Division	Price/Pcs. (₹)
971A/1	-10-50°C	1/1	165.00
971A/2	-10-110°C	1/1	165.00
971A/3	-10-110°C	1/2	165.00

**971AN** Chemical Thermometer "JSGW" Red spirit filled 30cm long made from imported capillary, Screen Printed Graduation with NABL Certificate.

Cat. No.	Range	Division	Price/Pcs. (₹)
971AN/1	-10-50°C	1/1	1035.00
971AN/2	-10-110°C	1/1	1035.00
971AN/3	-10-110°C	1/2	1035.00

**972** Adjustable PTFE cone for holding Thermometers of Cat. No. 971.

Cat. No.	Cone Size	Price/Pcs. (₹)
972/2	14/23	680.00
972/3	19/26	925.00
972/4	24/29	1150.00

**973** Precision Chemical Thermometers, "JSGW". Accuracy  $\pm 1$  division, red Spirit filled.

Cat. No.	Range	Division	Price/Pcs. (₹)
973/1	-10-50°C	1/5	330.00
973/2	-10-50°C	1/10	405.00
973/3	-10-110°C	1/5	415.00
973/4	-10-110°C	1/10	480.00

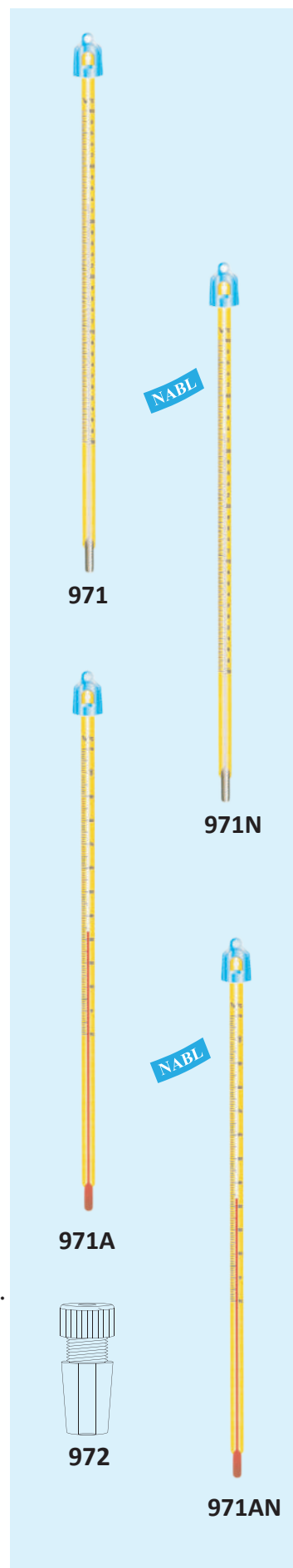

**973N Precision Chemical Thermometers, "JSGW".** Accuracy  $\pm 1$  division, red Spirit filled with **NABL** Certificate.

Cat. No.	Range	Division	Price/Pcs. (₹)
973N/1	-10-50 °C	1/5	1070.00
973N/2	-10-50 °C	1/10	1175.00
973N/3	-10-110 °C	1/5	1230.00
973N/4	-10-110 °C	1/10	1270.00

**974 Thermometers, "JSGW" with cone, enclosed Type.** Accuracy  $\pm 1$  division.

Cat. No.	Range	Cone	Price/Pcs. (₹)
974/1	-10-50 °C	10/19	730.00
974/2	-10-110 °C	14/23	805.00
974/3	0-250 °C	14/23	805.00
974/4	0-360 °C	14/23	805.00
974/5	-10-110 °C	19/26	890.00
974/6	0-250 °C	19/26	890.00
974/7	0-360 °C	19/26	890.00
974/8	-10-110 °C	24/29	1080.00
974/9	0-250 °C	24/29	1080.00
974/10	0-360 °C	24/29	1080.00

**974N Thermometers, "JSGW" with cone, enclosed Type.** Accuracy  $\pm 1$  division. with **NABL** Certificate.

Cat. No.	Range	Cone	Price/Pcs. (₹)
974N/1	-10-50 °C	10/19	1390.00
974N/2	-10-110 °C	14/23	1575.00
974N/3	0-250 °C	14/23	1575.00
974N/5	-10-110 °C	19/26	1675.00
974N/6	0-250 °C	19/26	1675.00
974N/8	-10-110 °C	24/29	1865.00
974N/9	0-250 °C	24/29	1865.00

**975 Immersion Thermometers, "JSGW" Mercury in glass, engraved on stem,** Accuracy  $\pm 1$  division.

Cat. No.	Range	Immersion length cm.	Total length cm.	Price/Piece (₹)
975/1	110 °C	15	45	530.00
975/2	250 °C	15	45	530.00
975/3	360 °C	15	45	530.00
975/4	110 °C	30	60	530.00
975/5	250 °C	30	60	530.00
975/6	360 °C	30	60	530.00

**975N Immersion Thermometers, "JSGW" Mercury in glass, engraved on stem,** Accuracy  $\pm 1$  division with **NABL** Certificate.

Cat. No.	Range	Immersion length cm.	Total length cm.	Price/Piece (₹)
975N/1	110 °C	15	45	1295.00
975N/2	250 °C	15	45	1295.00
975N/4	110 °C	30	60	1390.00

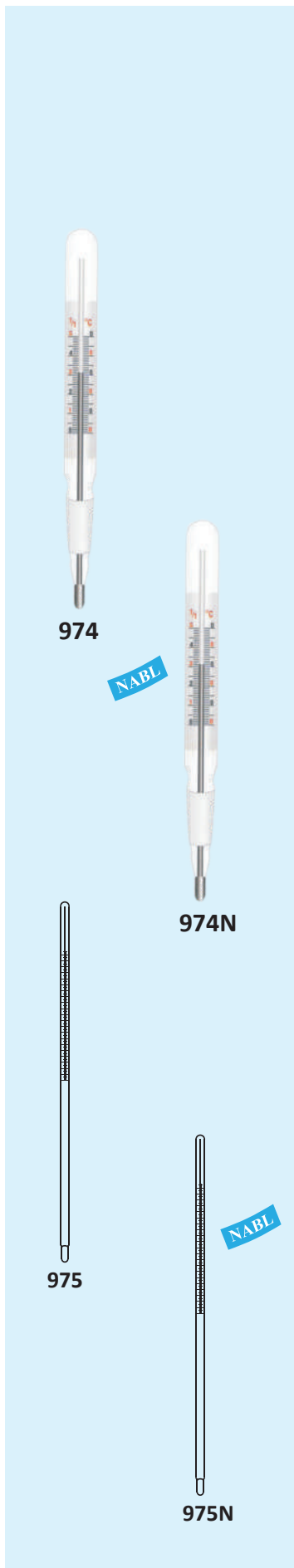

976 Low Temperature Thermometers, "JSGW" (Red Spiritfilled) 30 cm. long. Accuracy  $\pm 1$  division.

Cat. No.	Range	Division	Price/Piece (₹)
976/1	-30 to +50°C	1°C	385.00
976/2	-50 to +50°C	1°C	385.00
976/3	-50 to +100°C	1°C	385.00
976/4	-100 to +50°C	1°C	480.00

977 Oven/Incubator Thermometers, "JSGW" L shaped size 200 mm. x 200 mm., Mercury in Glass. Accuracy  $\pm 1$  division.

Cat. No.	Range	Division	Price/Piece (₹)
977/1	110°C	1°C	530.00
977/2	260°C	2°C	530.00
977/3	360°C	2°C	530.00

978 Straight Industrial Thermometers, "JSGW" enclosed type, Accuracy  $\pm 1$  division.

Cat. No.	Range	Immersion length cm.	Total length cm.	Price/Piece (₹)
978/1	50°C	10	30	550.00
978/2	110°C	10	30	550.00
978/3	250°C	10	30	550.00
978/4	360°C	10	30	550.00
978/5	110°C	20	40	645.00
978/6	250°C	20	40	660.00
978/7	360°C	20	40	665.00

979 Maximum and Minimum Thermometer with Plastic Body 480.00

980 – do – Superior Quality, Plastic moulded frame similar to Zeal 1390.00

981 Wet and Dry Thermometer. 480.00

982 – do – Superior Quality, Plastic moulded frame similar to Zeal 1390.00

983 Wall Thermometer in Plastic Groove type Base Plate, 20 cm. 280.00

985 Wall Thermometer in Plastic Groove type Base Plate, 40 cm. 460.00

986 Wall Thermometer, "JSGW", wooden base, 50cm 955.00

987 Clinical Thermometer, ISI marked. 280.00

990 Soil Thermometer, with brass cone at bottom, fitted in wooden body, range 100°C or 180°F, 100 mm long brass cone 1005.00

993 Psychrometer, (Whirling Hygrometer) in plastic frame, with chart 1410.00

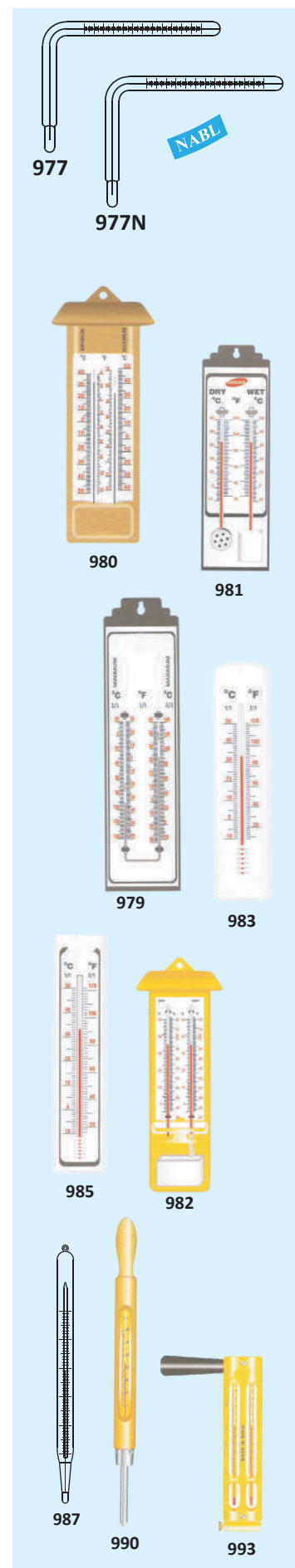

## HYDROMETERS

### 1001 Specific Gravity Hydrometers, in 100° range, shot weighted with paper scale.

Cat. No.	Range Sp. Gr.	Price/Piece (₹)
1001/1	600-700	500.00
1001/2	700-800	395.00
1001/3	800-900	395.00
1001/4	900-1000	395.00
1001/5	1000-1100	395.00
1001/6	1100-1200	395.00
1001/7	1200-1300	395.00
1001/8	1300-1400	395.00
1001/9	1400-1500	445.00
1001/10	1500-1600	445.00
1001/11	1600-1700	445.00
1001/12	1700-1800	445.00
1001/13	1800-1900	990.00
1001/14	1900-2000	990.00

### 1002 Universal Hydrometer accurate Range 700-2000 Sp.Gr.

395.00

### 1003 Beame Hydrometer, Shot weighted, with paper scale.

Cat. No.	Range	Price/Piece (₹)
1003/1	Light liquid range 10-70 Be, 0.700-1.000 Sp. Gr.	200.00
1003/2	Heavy liquid range 0-70 Be, 1.000-2.000 Sp. Gr.	200.00
1003/3	Beame Hydrometer range 0-50 Be, 1.000-1.500 Sp. Gr.	395.00
1003/4	Beame Hydrometer range 50-70 Be, 1.500-2.000 Sp. Gr.	490.00

### 1004 Beame Hydrometer, In 20 degree range, shot weighted with paper scale.

Cat. No.	Range	Price/Piece (₹)
1004/1	0-10 Be	395.00
1004/2	10-20 Be	395.00
1004/3	20-30 Be	395.00
1004/4	30-40 Be	395.00
1004/5	40-50 Be	395.00
1004/6	50-60 Be	445.00
1004/7	60-70 Be	445.00

### 1005 Beame Hydrometer, in 20 degree range shot weighted, with paper scale.

Cat. No.	Range	Price/Piece (₹)
1005/1	0 - 20 Be	445.00
1005/2	20-40 Be	445.00
1005/3	40-60 Be	445.00

### 1006 Brix Hydrometer, Shot weighted, with paper scale, without thermometer.

1006/1	0-10 Bx, 10-20 Bx, 20-30 Bx 30-40 Bx, 40-50 Bx, 50-60 Bx	690.00
1006/2	60-70 Bx, 70-80 Bx, 80-90 Bx	690.00
1006/3	0-30 Bx, 30-60 Bx, 60-90 Bx	690.00

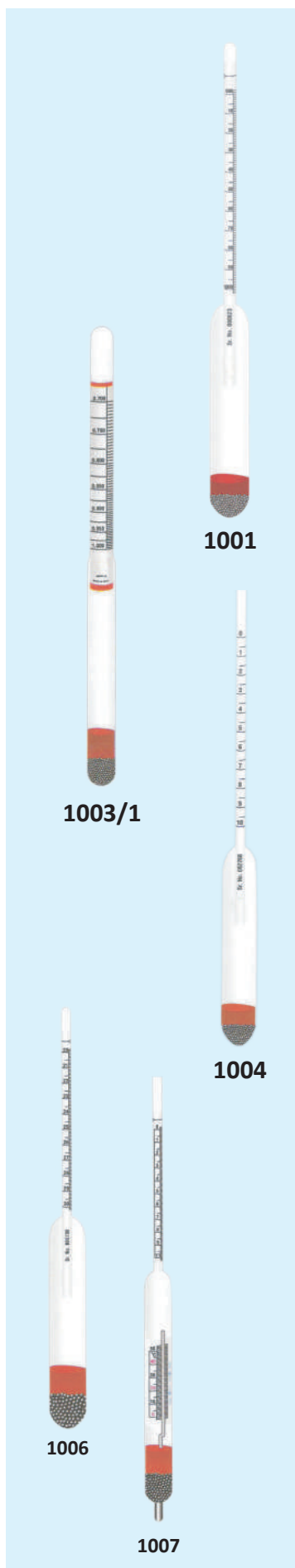

1007 Brix Hydrometer, Shot weighted, with paper scale, built in thermometer.

Cat. No.	Range Bx.	Price/Piece (₹)
1007/1	0-10 Bx	1365.00
1007/2	10-20 Bx	1365.00
1007/3	20-30 Bx	1365.00
1007/4	30-40 Bx	1365.00
1007/5	40-50 Bx	1365.00
1007/6	50-60 Bx	1365.00

1008 Sike's Hydrometer, Shot weighted, with paper scale.

Cat. No.	Range Sike's	Price/Piece (₹)
1008/1	0-20	695.00
1008/2	20-40	695.00
1008/3	40-60	695.00
1008/4	60-80	695.00
1008/5	80-100	695.00

1009 Twaddle Hydrometers.

Cat. No.	Size No.	Range Tw	Price/Piece (₹)
1009/1	1	0-26	445.00
1009/2	2	24-50	445.00
1009/3	3	48-74	445.00
1009/4	4	72-104	465.00
1009/5	5	102-138	465.00
1009/6	6	136-174	465.00

1011 Lactometer, Sp. Gr. range 1.000 to 1.440, Silver Coated. 260.00

1015 Density Hydrometer ISI marked. Shot & wax poised, adjusted for use at 15°C, M - 50 SP

Cat. No.	Sp. Gr. Range	For Use	Price/Piece (₹)
1015/1	0.650-0.700	ATF(Sea)	620.00
1015/2	0.700-0.750	Petrol	620.00
1015/3	0.750-0.800	Kerosene	620.00
1015/4	0.800-0.850	Diesel	620.00
1015/5	0.850-0.900	Mobile Oil	620.00
1015/6	0.900-0.950	Oils	620.00
1015/7	0.950-0.1000	Petroleum Ether	620.00



1008



1009



1011



1015

## SEMI MICRO ANALYSIS GLASSWARE

### 1028 Boiling Tubes with rim.

Cat. No.	Size mm	Minimum Qty/Pack	Price/Piece (₹)
1028/1	75 x 10	100	13.00
1028/2	75 x 12	100	13.00
1028/3	100 x 12	100	17.00
1028/4	60 x 15	50	31.00
1028/5	60 x 25	50	42.00

### 1029 Dropping Bottle, Soda glass, polythene stopper with dust proof head, glass dropper and rubber teat.

Cat. No.	Capacity ml.	Minimum Qty/Pack	Price/Piece (₹)
1029/1	30	12	150.00
1029/2	60	12	190.00
1029/3	120	12	210.00

### 1030 Dropping Bottle, Soda glass, Amber colour, PP stopper with dust proof head.

Cat. No.	Capacity ml.	Minimum Qty/Pack	Price/Piece (₹)
1030/1	30	12	250.00
1030/2	60	12	270.00
1030/3	120	12	350.00

### 1031 Dropping Bottle, T.K. Pattern Soda glass with grooved stopper.

Cat. No.	Capacity ml.	Minimum Qty/Pack	Price/Piece (₹)
1031/1	30	12	155.00
1031/2	60	12	180.00
1031/3	120	12	235.00

### 1033 Dropper, with capillary jet and rubber teat.

Cat. No.	Description	Minimum Qty/Pack	Price/Piece (₹)
1033/1	5 cm. with 5 cm. jet	10	52.00
1033/2	8 cm. with 10 cm. jet	10	59.00

### 1034 Dropper, with rubber teat 15 cm.

46.00

### 1035 Micro Funnel, 20 mm. Dia.

76.00

### 1036 Gas Absorption Pipette, with rubber cork fitted in 75 x 10 mm. Test tube.

103.00

### 1037 Filter Tube, Test Tube 75 x 10 mm with 55x7 mm filter tube.

66.00

### 1041 Semi Micro, Test tube holder with wooden handle.

51.00

### 1042 Semi Micro, Test tube brush.

47.00

### 1044 Semi-Micro, Stainless steel spatula

60.00

### 1045 Centrifuge Machine, Hand driven with two tubes.

2475.00

### 1046 – do – Hand driven with four tubes.

2675.00

### 1048 Platinum Wire, 35 x 0.2 mm. Fused in glass rod and fitted in test tube.

650.00

### 1051 Spot Plate

Cat. No.	No. of Cavities	Price/Piece (₹)
1051/1	6	240.00
1051/2	12	240.00

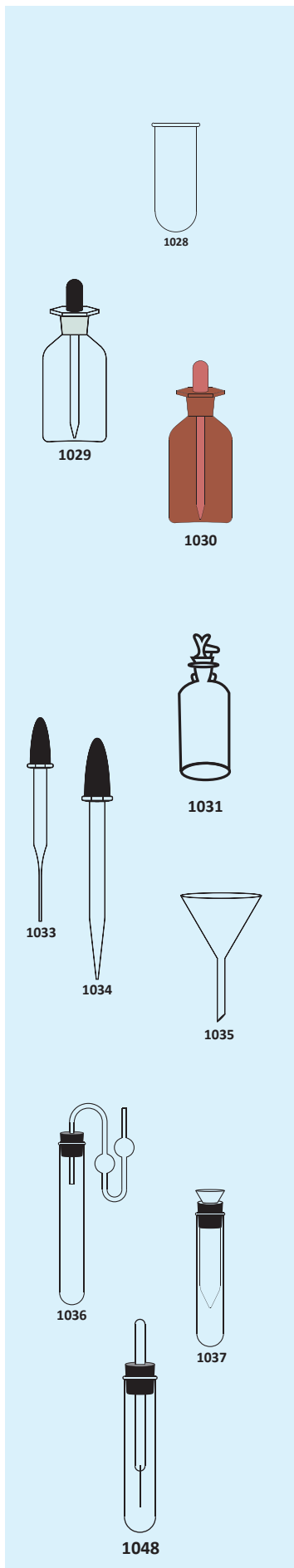

1052 Watch Glass

Cat. No.	Dia mm.	Minimum Qty/Pack	Price/Piece (₹)
1052/1	50	10	28.00
1052/2	65	10	34.00
1052/3	75	10	40.00
1052/4	100	10	54.00
1052/5	125	10	94.00
1052/6	150	10	119.00

1053 Semi Micro Sintered Funnel, 10 ml. 305.00

1055 Stirring Rod, 250 mm. Indian glass. 21.00

1056 Semi Micro, Mortar and pestle 75 mm 160.00

1057 Semi Micro, Crucible porcelain 15 ml 81.00

1058 Kipp's Apparatus, 100 ml. 1795.00

1060 Wire Gauge with Frame. 58.00

1061 Agate Mortor & Pestle, Black.

Cat. No.	Size mm.	Minimum Qty/Pack	Price/Piece (₹)
1061/1	50	2	1290.00
1061/2	75	1	2100.00
1061/3	100	1	3820.00
1061/4	125	1	5890.00
1061/5	150	1	10650.00

1062 Porcelain Buchner Funnel

Cat. No.	Top Dia mm.	Filter Paper mm.	Minimum Qty/Pack	Price/Piece (₹)
1062/1	35	27	12	175.00
1062/2	50	40	12	185.00
1062/3	60	50	12	195.00
1062/4	75	70	6	290.00
1062/5	100	90	6	410.00
1062/6	125	110	6	575.00
1062/7	150	130	4	980.00
1062/8	200	170	2	2735.00
1062/9	250	230	2	4270.00
1062/10	300	260	2	8040.00

1063 Porcelain Crucible low form with lid.

Cat. No.	Capacity ml.	Minimum Qty/Pack	Price/Piece (₹)
1063/1	15	10	77.00
1063/2	25	10	105.00
1063/3	50	10	150.00
1063/4	75	10	180.00
1063/5	100	5	215.00
1063/6	150	5	235.00

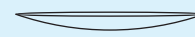

1052



1053

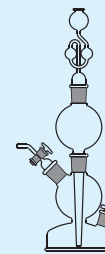

1058

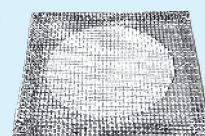

1060



1061



1062



1063



1064

**1064 Porcelain Evaporatin Dish without lid.**

Cat. No.	Capacity ml.	Top Dia mm	Minimum Qty/Pack	Price/Piece (₹)
1064/1	20	50	10	77.00
1064/2	100	75	10	100.00
1064/3	175	100	10	150.00
1064/4	400	125	10	335.00
1064/5	800	150	5	475.00
1064/6	1800	200	2	1295.00



1065

**1065 Alumina Crucible without lid. With stand upto 1700° C.**

Cat. No.	Capacity ml.	Minimum Qty/Pack	Price/Piece (₹)
1065/1	15	2	935.00
1065/2	25	2	1275.00
1065/3	40	2	1390.00
1065/4	65	2	2265.00
1065/5	100	2	2780.00
1065/6	140	2	3760.00

## QUARTZ (Transparent) LABORATORY WARE

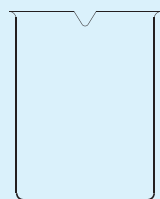

1071

**1071 Beakers "JSGW", Low Form with spout, Quartz Glass.**

Cat. No.	Capacity ml.	Minimum Qty/Pack	Price/Piece (₹)
1071/1	50	1	2290.00
1071/2	100	1	4410.00
1071/3	250	1	7700.00
1071/4	500	1	13200.00
1071/5	1000	1	22815.00
1071/6	25	1	1655.00

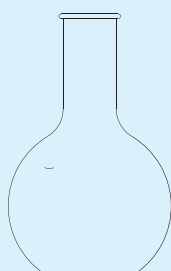

1072

**1072 Flask "JSGW", (Round Bottom/Flat Bottom), Quartz Glass.**

Cat. No.	Capacity ml.	Minimum Qty/Pack	Price/Piece (₹)
1072/1	25	1	5780.00
1072/2	50	1	6900.00
1072/3	100	1	10230.00
1072/4	250	1	16075.00
1072/5	500	1	19805.00
1072/6	1000	1	36460.00

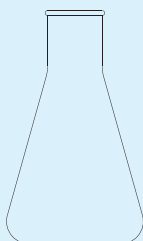

1073

**1073 Flask Conical "JSGW", Quartz Glass.**

Cat. No.	Capacity ml.	Minimum Qty/Pack	Price/Piece (₹)
1073/1	25	1	5780.00
1073/2	50	1	6900.00
1073/3	100	1	10230.00
1073/4	250	1	16075.00
1073/5	500	1	19805.00
1073/6	1000	1	36460.00

1074 Flask Volumetric, "JSGW", with Stopper `Class A', Quartz Glass.

Cat. No.	Capacity ml.	Minimum Qty/Pack	Price/Piece (₹)
1074/1	10	1	6600.00
1074/2	25	1	7835.00
1074/3	50	1	9280.00
1074/4	100	1	12795.00
1074/5	250	1	15930.00
1074/6	500	1	18285.00
1074/7	1000	1	32430.00

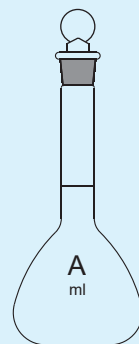

1074

1075 Measuring Cylinder, "JSGW", with Spout Class 'A', Quartz Glass.

Cat. No.	Capacity ml.	Minimum Qty/Pack	Price/Piece (₹)
1075/1	10	1	8855.00
1075/2	25	1	9890.00
1075/3	50	1	13515.00
1075/4	100	1	28175.00
1075/5	250	1	39790.00
1075/6	500	1	55315.00

1075

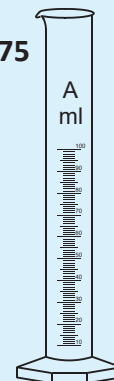

1076

1076 Pipettes Transfer Volumetric, "JSGW", Class 'A', Quartz Glass.

Cat. No.	Capacity ml.	Minimum Qty/Pack	Price/Piece (₹)
1076/1	1	1	8740.00
1076/2	2	1	8800.00
1076/3	5	1	11155.00
1076/4	10	1	15525.00

1077 Quartz Cell with PTFE Cover, 10mm path, 3.5 ml. in pair 5030.00

1077



1078 Glass Cuvette with PTFE Cover, 10mm path, 3.5 ml in pair. 1900.00

1079 Quartz Basins, "JSGW", with spout, Round Bottom, transparent.

Cat. No.	Capacity ml.	Dia x Ht. Approx.	Minimum Qty/Pack	Price/Piece (₹)
1079/1	20	55 x 23	2	1455.00
1079/2	45	75 x 27	2	4135.00
1079/3	70	85 x 35	2	5160.00
1079/4	85	95 x 36	2	8455.00
1079/5	100	100 x 38	1	10260.00
1079/6	200	115 x 47	1	15520.00

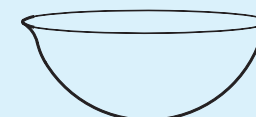

1079

1080 Test Tube with Rim, made from Quartz Glass.

Cat. No.	Capacity ml.	O.D. x Length	Minimum Qty/Pack	Price/Piece (₹)
1080/1	3	10x75	5	320.00
1080/2	5	12x75	5	340.00
1080/3	8	12x100	5	445.00
1080/4	10	16x125	5	735.00
1080/5	15	16x150	5	935.00
1080/6	25	18x150	2	1500.00
1080/7	35	25x100	2	1815.00
1080/8	50	25x150	2	2070.00
1080/9	75	25x200	2	2245.00
1080/10	100	32x200	2	2830.00
1080/11	175	40x200	2	3765.00



1080

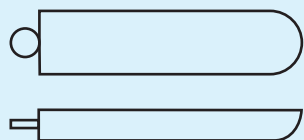

1081

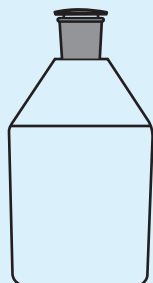

1083

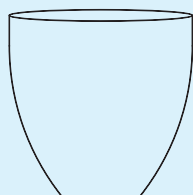

1085

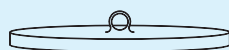

1085 L

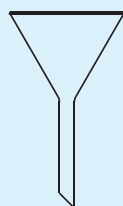

1087

1081 Combustion Boats with Handle, made from Quartz Glass.

Cat. No.	O.D. x Length mm. (approx.)	Minimum Qty/Pack	Price/Piece (₹)
1081/1	16x49	2	880.00
1081/2	12x77	2	1155.00
1081/3	18x77	2	1295.00
1081/4	22x77	2	1655.00
1081/5	22x100	2	2020.00

1083 Quartz Glass, Reagent Bottle with Hollow Quartz I/C Stopper.

Cat. No.	Capacity ml.	Minimum Qty/Pack	Price/Piece (₹)
1083/1	25	1	3910.00
1083/2	50	1	4860.00
1083/3	100	1	7345.00
1083/4	250	1	11725.00
1083/5	500	1	15165.00

1084 Quartz Tubing, Clear, all sizes.

P.O.R.

1085 Quartz Crucibles, "JSGW".

Cat. No.	Capacity ml.	Minimum Qty/Pack	Price/Piece (₹)
1085/1	15	5	775.00
1085/2	25	5	1160.00
1085/3	50	5	1775.00
1085/4	80	5	2495.00
1085/5	100	2	2840.00
1085/6	150	2	4435.00

1085 L Lids for Quartz Crucibles, "JSGW"

Cat. No.	Capacity ml.	Minimum Qty/Pack	Price/Piece (₹)
1085 L/1	15	5	665.00
1085 L/2	25	5	1040.00
1085 L/3	50	5	1660.00
1085 L/4	80	5	2360.00
1085 L/5	100	2	2705.00

1086 Quartz Glass Crucibles, Gooch type with sintered Disc of Porosity G-1 or G-2 or G-3 or G-4. Temperature Range upto 1000°C.

Cat. No.	Capacity ml.	Minimum Qty/Pack	Price/Piece (₹)
1086/1	15	5	10660.00
1086/2	30	5	11255.00
1086/3	50	5	12435.00

1087 Funnel Filtering, "JSGW", 60° angle with stem, made from Quartz Glass.

Cat. No.	Capacity ml.	Minimum Qty/Pack	Price/Piece (₹)
1087/1	50	1	3565.00
1087/2	75	1	4830.00
1087/3	100	1	8625.00

## SILICA LABORATORY WARE

- 1091 Silica Crucibles, "JSGW", with lid, withstands 800°C. **With Individual Numbering.**

Cat. No.	Capacity ml.	Minimum Qty/Pack	Price/Piece (₹)
1091/1	15	4	1005.00
1091/2	25	4	1405.00
1091/3	50	4	2340.00
1091/4	100	2	5315.00
1091/5	80	2	4490.00
1091/6	150	2	6290.00

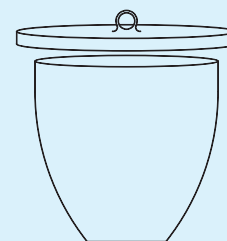

1091

- 1092 Silica Crucibles, "JSGW", without lid, withstands 800°C. **With Individual Numbering.**

Cat. No.	Capacity ml.	Minimum Qty/Pack	Price/Piece (₹)
1092/1	15	5	605.00
1092/2	25	5	700.00
1092/3	50	5	1230.00
1092/4	100	5	2705.00
1092/5	80	5	2290.00
1092/6	150	2	3625.00

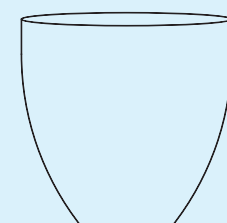

1092

- 1093 Silica Basins, "JSGW", with spout, Round Bottom, translucent, withstands 800°C. **With Individual Numbering.**

Cat. No.	Capacity ml.	Dia x Ht. Approx.	Minimum Qty/Pack	Price/Piece (₹)
1093/1	20	55 x 23	5	1040.00
1093/2	45	75 x 27	5	1645.00
1093/3	70	87 x 33	5	2185.00
1093/4	85	94 x 36	5	2975.00
1093/5	100	100 x 45	5	4120.00
1093/6	200	113 x 47	2	4810.00



1093

## PLANT PHYSIOLOGY

1120	Apparatus for experiments on root pressure, T-tube with stopcock and Borosilicate Glass Graduated Jar, without pot.	1390.00
1121	High Pressure Manometer, Ganong's.	700.00
1122	Apparatus for the demonstration of Osmotic Pressure, Pfeffer's complete with Borosilicate Glass Jar.	1235.00
1123	Apparatus for determining the quality of water absorbed and given off by transpiring plants, Borosilicate Glass bottle, Borosilicate Glass side tubes.	1235.00
1124	Potometer, for observing the rate of absorption of water by transpiring plants under varying circumstances, complete.	2090.00
1125	Potometer, Farmer's Borosilicate Glass bottle, borosilicate glass fitting	1865.00
1126	Potometer, Ganong's	1245.00
1127	Apparatus for demonstrate suction due to transpiration. A capillary tube with funnel at top and scale attached.	615.00
1128	Apparatus for investigating transpiration, Complete on stand.	2775.00
1129	Respirometer, Complete with graduated and levelling tubes, rubber tubing and stand.	2435.00
1130	Fermentation Vessel, Kuhn's on stand.	780.00
1131	Demonstration Respiroscope, with Borosilicate Glass bottle	1670.00
1132	Retort Shaped Vessel, for the culture of plants in a space devoid of oxygen.	625.00
1133	Willmout Bubbler with Borosilicate Glass bottle.	1240.00

## ANAEROBIC CULTURE JAR

1141	Anaerobic Culture Jar (Mcintosh and Fildes Pattern), "JSGW", for the safe growth of anaerobes through COLD CATALYST. It consists of a glass Jar approx. 23 cm. high x 13 cm. dia., metal cover fitted with two needle valves for evacuating and filling and a sachet for holding the Catalyst, but without catalyst. The jar can be used both with Gas cylinder as well as with Gas packs. Complete with petri dish holder.	24810.00
1142	– do – with pressure gauge.	26690.00
1146	Anaerobic Culture Jar and with vacuum cum Pressure gauge, Supplied with transparent, unbreakable polycarbonate jar of 3.5 litre capacity, having sturdy Aluminium Lid, clamp and sealing ring with built in Safety features, pressure valve with Safety Valve & 2 way Pressure Gauge. Supplied with SS Test Tube carrier, SS Petri plate Carrier for 10.	38330.00

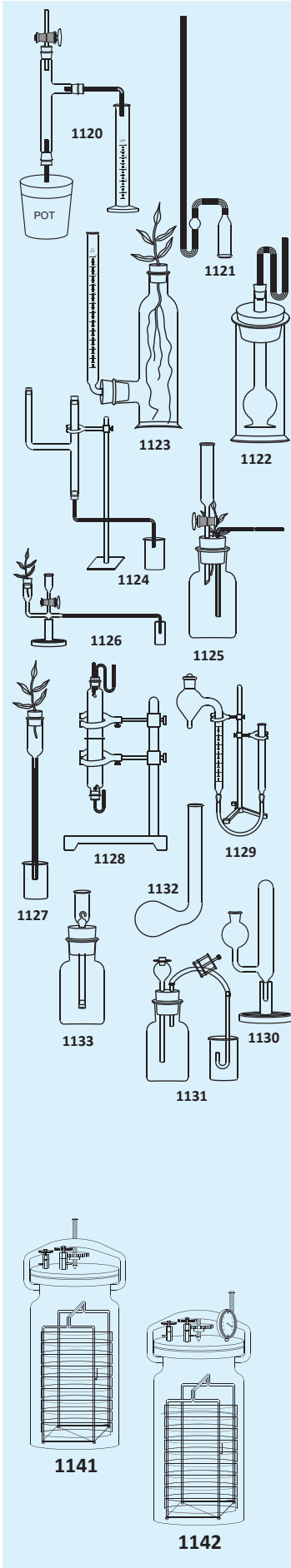

## PTFE LABORATORY WARES

### 1151 PTFE Interchangeable Stopper, "JSGW", Hexagonal head.

Cat. No.	Size	Minimum Qty/Pack	Price/Piece (₹)
1151/1	10/19	5	320.00
1151/2	14/23	5	575.00
1151/3	19/26	5	780.00
1151/4	24/29	5	1095.00
1151/5	29/32	5	1305.00
1151/6	34/35	2	1750.00



1151

### 1152 PTFE Coated Magnetic Stirring Bar, "JSGW"

Cat. No.	Length x Dia mm.	Minimum Qty/Pack	Price/Piece (₹)
1152/1	10 x 6	10	200.00
1152/2	15 x 8	10	235.00
1152/3	20 x 8	10	275.00
1152/4	25 x 8	10	315.00
1152/5	30 x 8	10	360.00
1152/6	35 x 8	10	415.00
1152/7	50 x 8	10	590.00
1152/8	40 x 8	10	450.00
1152/9	60 x 10	10	870.00



1152

### 1152 A Oval Shaped, PTFE Magnetic Stirring Bar, "JSGW".

Cat. No.	Length x Dia mm.	Minimum Qty/Pack	Price/Piece (₹)
1152A/1	10 x 6	10	280.00
1152A/2	15 x 7	10	340.00
1152A/3	20 x 8	10	390.00
1152A/4	25 x 9	10	435.00
1152A/5	30 x 10	10	570.00
1152A/6	35 x 11	10	665.00
1152A/7	50 x 16	10	1120.00

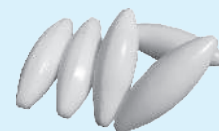

1152 A

### 1153 PTFE Beakers with lip, "JSGW".

Cat. No.	Capacity ml.	Minimum Qty/Pack	Price/Piece (₹)
1153/1	25	2	1020.00
1153/2	50	2	1885.00
1153/3	100	2	3450.00
1153/4	250	1	6400.00
1153/5	400	1	7210.00
1153/6	500	1	8520.00
1153/7	1000	1	13410.00
1153/8	2000	1	34090.00



1153

### 1154 PTFE Lid for Beakers

Cat. No.	Suitable for Beaker Capacity (ml.)	Minimum Qty/Pack	Price/Piece (₹)
1154/1	25	2	145.00
1154/2	50	2	310.00
1154/3	100	2	390.00
1154/4	250	1	575.00
1154/5	400	1	645.00
1154/6	500	1	820.00
1154/7	1000	1	1070.00
1154/8	2000	1	1555.00



1154

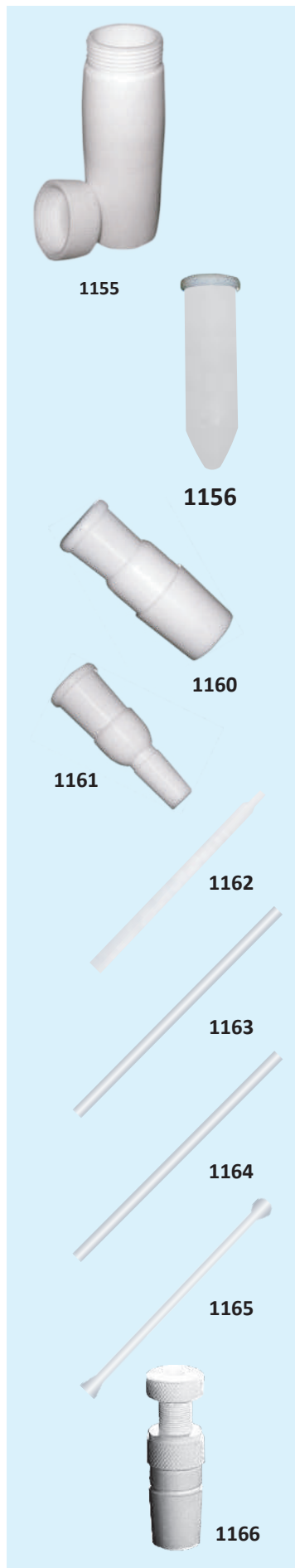

**1155 PTFE Bottle, "JSGW", with Screw Cap.**

Cat. No.	Capacity ml.	Minimum Qty/Pack	Price/Piece (₹)
1155/1	100	1	7675.00
1155/2	125	1	8520.00
1155/3	150	1	9070.00
1155/4	250	1	9455.00
1155/5	500	1	17900.00
1155/6	1000	1	31880.00

**1156 PTFE Centrifuge Tube, "JSGW", Round or Conical.**

Cat. No.	Capacity ml.	Minimum Qty/Pack	Price/Piece (₹)
1156/1	15	1	1605.00
1156/2	25	1	2025.00
1156/3	50	1	2420.00
1156/4	100	1	3210.00

**1160 PTFE Reduction Adapter**

Cat. No.	Socket	Cone	Minimum Qty/Pack	Price/Piece (₹)
1160/1	14/23	19/26	2	1460.00
1160/2	19/26	24/29	2	1840.00
1160/3	24/29	34/35	2	2255.00
1160/4	34/35	55/42	2	3905.00

**1161 PTFE Expansion Adapter**

Cat. No.	Socket	Cone	Minimum Qty/Pack	Price/Piece (₹)
1161/1	19/26	14/23	2	1460.00
1161/2	24/29	19/26	2	1840.00
1161/3	34/35	24/29	2	2255.00
1161/4	55/42	34/35	2	3905.00

**1162 PTFE Policeman (Magnet Retriever) Cylindrical permanent magnet sealed at the end for removal or insertion of bars.**

Cat. No.	O.D. x Length	Minimum Qty/Pack	Price/Piece (₹)
1162/1	12x300 mm	2	1370.00
1162/2	12x400 mm	2	1855.00

**1163 PTFE Stirrer Plain with S.S. Rod encapsulated for increased stiffness.**

1163/1	8x200 mm	2	1195.00
1163/2	10x250 mm	2	1490.00
1163/3	12x300 mm	2	2100.00

**1164 PTFE Stirrer Rod Plain**

1164/1	8x200 mm	5	235.00
1164/2	10x250 mm	5	330.00
1164/3	12x300 mm	5	560.00
1164/4	19x500 mm	5	1855.00

**1165 PTFE Stirrer Scraper**

1165/1	10x200 mm	2	2635.00
1165/2	12x250 mm	2	3180.00
1165/3	12x300 mm	2	3680.00

**1166 PTFE Stuffing Box Gland**

Cat. No.	Cone Size	Minimum Qty/Pack	Price/Piece (₹)
1166/1	19/26	2	1165.00
1166/2	24/29	2	1395.00
1166/3	29/32	2	1635.00
1166/4	34/35	2	1940.00

## CHROMATOGRAPHY

- 1175 Thin Layer Chromatography Kit "JSGW"**, Comprising of moveable applicator (Spreader) with builtin arrangement, 0-2 mm, perspex base plate 114 x 23 cm., Aluminium Carrier, perspex spotting temp. plate, developing chamber with lid, five T.L.C. plates 20 x 20 cm., two T.L.C. plates 20 x 5 cm., scriber for marking lines, micropipette and glass sprayer with rubber bellow.

Cat. No.	Description	Price/Piece (₹)
1175/1	With Chrome plated Brass Applicator	28980.00
1175/2	With Aluminium Applicator	22785.00

### SPARES AND ACCESSORIES

1175/3	Applicator Brass	13285.00
1175/4	Applicator Aluminium	6305.00
1175/5	Spotting Temp plate, perspex	1275.00
1175/6	Aluminium Carrier for ten plates of 20 cm x 20 cm	2805.00
1175/7	Plate rack of S.S. for two plates, 20x20 cm.	1275.00
1175/8	T.L.C. Glass Plates 20x20 cm.	165.00
1175/9	– do – 20x10 cm.	107.00
1175/10	– do – 20x 5 cm.	100.00
1175/11	Chromatography Tank (Developing Chamber, 250x250x150mm) with cover for T.L.C. Plates of size 20 x 20 cm.	5815.00
1175/12	– do – 225x225x125 mm.	3875.00
1175/13	– do – 220x140x140 mm.	2990.00
1175/14	Perspex Base plate size approx. 114 x 23 cm.	3865.00
1175/15	Dessicator Cabinet 30x50x35cm.	18700.00

- 1176 Paper Chromatography Cabinet "JSGW"**, Ascending or Descending, made of teak wood and glass construction. It can accommodate two (troughs) and six glass rods.

Cat. No.	Description	Price/Piece (₹)
1176/1	Cabinet size : 60x30x60 cm. approx for 4 filter papers of 46x57 cm. Size	34160.00
1176/2	Cabinet size : 80x37.5x65 cms approx for 6 filter papers of 75 x 75 cm. size	37660.00
1176/3	Glass Boats for cabinet 1176/1	2495.00
1176/4	Glass Boats for cabinet 1176/2	2865.00

- 1177 Ultra Violet Chromatography Inspection Cabinet, "JSGW"** for viewing and detecting separated substances on T.L.C. Layers, fitted with long wave (365 nm.) U.V. Lamp for use on 220 volts A.C. 15880.00

- 1178 Ultra Violet Chromatography Inspection Cabinet, "JSGW"** for viewing and detecting separated substances on T.L.C. Layers, fitted with two long wave (365 nm.) U.V. tubes for use on 220 volts A.C., Same as Cat. No. 1177 17655.00

- 1179 Ultra Violet Fluorescence Inspection Cabinet, "JSGW"**, Dual wave, having filter fitted with separate low pressure mercury vapour tubes for short ultra violet (254 nm) and long UV (365 nm) plus separate lamp for visible light. The low pressure mercury vapour tubes facilitate immediate use. 28900.00

- 1179/1 Spare - Ultra Violet Tube, 254 nm** 1625.00

- 1179/2 Spare - Ultra Violet Tube, 365 nm** 1670.00

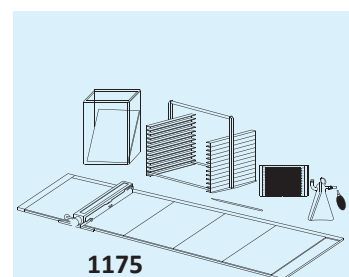

1175

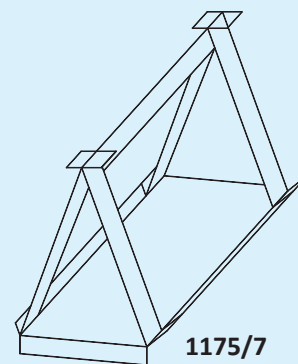

1175/7



1176



1177 / 1178

## ROTARY VACUUM EVAPORATOR



1187

1187. **Rotary Vacuum Flash Evaporator (Digital Model) :**  
 Fitted with 40W, AC motor, continuously frequency variable speed control 20-200 RPM, digital display, water bath with RT to 90°C temperature control, Heater 1.5KW, jack lifting upto 150mm, Boiling flask 2000 ml, vertical coil condenser, with automatic feed arrangement, receiver flask with ball cup joint etc. (₹) 400815.00



1187A

- 1187 A **Rotary Vacuum Flash Evaporator :**  
 Rotary evaporator is supplied complete with Geared drive, fitted with Auto Lifting Assembly Arrangement for positioning glass assembly, **Variable Digital RPM cum temperature cum timer controller.** Stainless steel water bath, double coiled glass condenser with three openings for vacuum and cooling, Pear shape evaporator flask capacity 800 ml. Receiver flask capacity one litre.  
 • Graphical LCD display • Temperature range : 0-100°C  
 • Timer : upto 99:59 hh:mm • RPM 20-280 • Water Low Protection  
 • Digital Motor Drive • High Motor Torque Operation  
 • Heater : 1000 watts • Power : 220 V AC, 50 Hz • All Digital Key (₹) 225210.00



1188/1

- 1188/1 Same as above, but Water Bath fitted with Digital Temperature Controller cum Indicator instead of thermostatically temp. Control (₹) 123495.00

### Spare Parts for Rotary Flash Evaporator :

1188/2	Condenser double coil with S-35 ball joint & Feed tube	13840.00
1188/3	Receiving flask 1 ltr cap. with S-35 cup joint.	2030.00
1188/4	Boiling Flask 800 ml. with 24/29 socket. For other capacities. Refer Cat. No. 168A.	1760.00
1188/5	Feed tube for condenser, with cone & Teflon tube	2130.00
1188/6	Vapour Path tube.	1660.00
1188/7	Silicon washer for condenser	430.00
1188/8	Oil seal rubber	300.00
1188/9	Tension spring for holding condenser	215.00
1188/10	Wire clip to hold boiling flask	96.00
1188/11	Vacuum pump for Rotary Flash Evaporator oil free	45545.00

- 1189 **Chiller Refrigerated Circulator** has built in circulating pump and water tank of rust proof stainless steel. The built in pump has a flow rate of 2.5 meters and internal tank capacity 10 litres. The temperature is controlled by a digital temp. Indicator cum controller. Cooling from -10°C to ambient. (₹) 178795.00

## KJELDHAL APPARATUS

1190. **Universal Combined Kjeldhal Digestion and Distillation Unit "JSGW"**  
Electrically heated, comprising of one single mild steel tubular stand provided with two shelves one above the other. A specially designed glass fume duct with B 24) Cone openings (suitable for flasks having 24/29 socket) having such provision so that no leakage of fumes takes place. One heater box having individual energy regulators for 500 watts heaters are supplied in digestion part at the lower side. One heater box of above design is supplied in distillation part at the upper side. Distillation part is also provided with brass condenser rack with water circulation systems and clamps. The whole unit is operated on 220 volts AC mains.

Cat. No.	Description	Price/Piece (₹)
1190/1G	Complete unit with glass parts for 6 tests	95470.00
1190/2	-do- without glass parts for 6 tests	55705.00
1190/3G	Complete unit with glass parts for 3 tests	59555.00
1190/4	-do- without glass parts for 3 tests	37135.00

*Note : For extra energy regulator Rs. 500/- extra.  
\*Installation charges extra on actual basis.*

1191. **Kjeldhal Digestion Unit, "JSGW"**, Complete with heating box and fume duct. The 500 watts heaters are 6 inches apart having individual on/off switches and energy regulators. The height of the side clamps provided, is adjustable to accommodate Kjeldhal flasks of 300 ml., 500 ml. or 800 ml. Without glass parts but with fume duct. Kindly place order for Kjeldhal flasks extra as per requirement.

Cat. No.	Description	Price/Piece (₹)
1191/1G	Unit with individual energy regulators for 3 Tests with 3x500ml flasks.	24175.00
1191/2	Unit with individual energy regulators for 3 Tests without flasks and fume duct.	14335.00
1191/3G	Unit with individual energy regulators for 6 Tests with 6x500ml flasks.	37135.00
1191/4	Unit with individual energy regulators for 6 Tests without flasks and fume duct.	25025.00
1191/5	Fume Duct for 3 Tests, Glass.	7320.00
1191/6	Fume Duct for 6 Tests, Glass.	8460.00
1191/7	Flasks Kjeldhal plain neck. 300 ml.	555.00
1191/8	Flasks Kjeldhal plain neck, 500 ml.	960.00
1191/9	Flasks Kjeldhal plain neck, 800 ml.	1175.00



1190

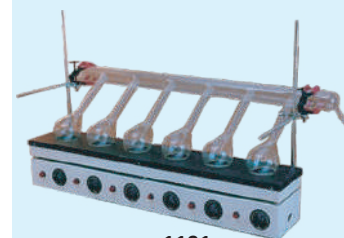

1191

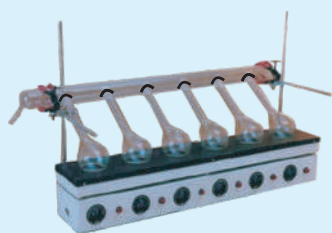

1192

1192. **Kjeldhal Digestion Unit "JSGW"** Complete with heating box & fume duct. 500 watts heaters are 6 inches apart having individual on/off switches & energy regulators. The height of the side clamps provided, is adjustable to accommodate Kjeldhal flasks of 300/500/or 800ml. With specially designed fume duct to totally avoid leakage of fumes with 24/29 cone adapters for openings suitable to fit Kjeldhal flasks having 24/29 Sockets but w/o flask.

Cat. No.	Description	Price/Piece (₹)
1192/1G	Unit with individual Energy regulators for 3 Tests with 3x500ml Kjeldhal flasks	25840.00
1192/2	Unit with individual Energy regulators for 3 Tests without flasks and fume duct.	14335.00
1192/3G	Unit with individual Energy regulators for 6 Tests with 6x500ml Kjeldhal flasks.	42385.00
1192/4	Unit with individual Energy regulators for 6 Tests without flasks and fume duct.	25020.00
1192/5	Specially designed Fume Duct with adapters, for 3 Tests for Cat. No. 1192/1G and 1192/2	9190.00
1192/6	Specially designed Fume Duct with adapters, for 6 Tests for Cat. No. 1192/3G & 1192/4	13920.00
1192/7	Kjeldhal Flasks suitable for above units 300 ml. Capacity with 24/29 socket.	690.00
1192/8	- do - 500 ml. with 24/29 socket.	1200.00
1192/9	- do - 800 ml. with 24/29 socket.	1365.00



1194

- 1194 **Kjeldhal Distillation Unit, "JSGW"**, Complete with mild steel tubular stand provided with one heating Box, Brass condenser rack with water circulation system, condenser clamps. Heater box is provided with top to receive the Kjeldhal flasks, with electric heating elements of 500 watts each connected through individual on/off switches and energy regulators, supplied with or without glass parts.

Cat. No.	Description	Price/Piece (₹)
1194/2	Unit with individual Energy regulators for 3 Tests w/o glass parts	24520.00
1194/2G	---do---with glass parts	37600.00
1194/4	Unit with individual Energy regulators for 6 Tests w/o glass parts	34505.00
1194/4G	---do---with glass parts	60665.00
1194/5	Kjeldhal Distillation Unit Glass Parts consisting of Kjeldhal flask 500 ml, multiple adapter dropping funnel, Splash head, Liebig condenser, receiving adapter & receiving flask 250 ml. complete with standard joint fitting.	5450.00

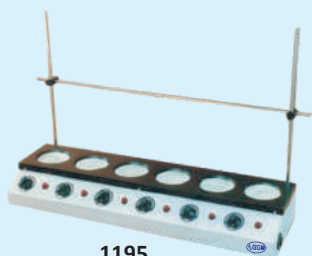

1195

- 1195 **Soxhlet Extraction Heating Unit, "JSGW"**, Suitable for flasks of 100 ml., 150 ml., 250 ml. or 500 ml. cap. Unit is supplied with Heating Box fitted with Heaters (Hot Plates or Heating Mantles) individual energy regulators, neon lights, etc. adjustable rod, clamps & boss heads, but without glass parts.

Cat. No.	Description	Price/Piece (₹)
1195/2	Unit With 3 Hot Plate Type Heaters	20330.00
1195/4	Unit With 6 Hot Plate Type Heaters	29570.00
1195/6	Unit with 3 Mantle Type Heaters	17720.00
1195/8	Unit with 6 Mantle Type Heaters	27035.00

*Note : For Glass part refer Cat. No. 431.*



1195A

- 1195A **Crude Fiber Estimation, Hot Plate type for 6 Tests**, complete with 6 x 1000 ml. Tall form beakers, 6 Bulb shape condensers, Clamps and Connecting Rubber Tube
- 49415.00

## LABORATORY INSTRUMENTS

1196. **Heating Mantles, "JSGW"**, made of Knitted Glass Yarn, heaters are fitted beneath it, which provides uniform heating of flasks upto 400°C. The mantles are fitted in a nicely painted sheet metal case, filled with Glass Wool insulations, provided with an energy regulator, indicator and a cord.

Cat. No.	Capacity ml.	Watts (W)	Price/Piece (₹)
1196/1	50	60	4015.00
1196/2	100	60	4060.00
1196/3	250	150	4295.00
1196/4	500	200	4665.00
1196/5	1000	300	5220.00
1196/6	2000	450	6530.00
1196/7	3000	450	8020.00
1196/8	5000	600	8910.00
1196/9	10000	2x600	15295.00
1196/10	20000	3x600	21410.00
1196/11	50000	6x600	43350.00

### SPARE MANTLES WITH HEATERS FOR REPLACEMENT

Cat.No	Capacity ml.	Watts	Price/Piece (₹)
1196/12	50	60	975.00
1196/13	100	60	975.00
1196/14	250	150	1045.00
1196/15	500	200	1115.00
1196/16	1000	300	1390.00
1196/17	2000	450	1855.00
1196/18	3000	450	2105.00
1196/19	5000	600	2935.00
1196/20	10000	2x600	4235.00
1196/21	20000	2x600	7950.00
1196/22	50000	6x600	17840.00



1196





1197



1197-2



1198/1



1199



12000

1197. Hot Plates, "JSGW", Mounted on a thick M.S. sheet body, a smooth surface cast iron plate fitted with an electrically operated element laid under the plate. **Fitted with Energy Regulator.** A three step rotary switch works on 220/230 volts A.C. controls heating. The plate is finished in heat resistant black and the body in stoved blue white painted.

Cat. No.	Top Type	Dimension cm	Power Rating	Price/Piece (₹)
1197/2	Round	20	1 Kw	9565.00
1197/6	Rectangular	30 x 25	1 Kw	12970.00
1197/8	Rectangular	40 x 25	1.5 Kw	15295.00
1197/10	Rectangular	45 x 30	2 Kw	15955.00
1197/12	Rectangular	45 x 60	3 Kw	26565.00

- 1197A Hot Plate, "JSGW", Mounted on a thick M.S. sheet body, a smooth surface of **Stainless Steel Plate** fitted with an electrically operated element laid under the plate. A three step rotary switch works on 220/230 volts A.C. controls heating.

Cat. No.	Top Type	Dimension cm	Power Rating	Price/Piece (₹)
1197A/1	Round	20	1 Kw	13140.00
1197A/2	Rectangular	40 x 25	1.5 Kw	19880.00
<b>Fitted with Digital Controller (PID)</b>				
1197A/3	Round	20	1 Kw	30465.00
1197A/4	Rectangular	40 x 25	1.5 Kw	37210.00

- 1198/1 Laboratory Stirrers, "JSGW", Equipped with noiseless universal motor fitted with chuck, stainless steel stirring shaft fitted with three bladed propeller and retort stand having cast iron base, S.S. vertical and horizontal rods and a mount, continuous speed control for varying speed upto 4000 RPM, with Digital RPM Display. 38230.00

1199. Magnetic Stirrer, "JSGW", A Fractional Horse Power motor mounted in a sheet metal housing, fitted with speed regulator, max. Speed 1200 RPM. Top plate stainless steel, supplied with PTFE coated stirring bar.

Cat. No.	Beaker Cap. Ltr.	Pan Size mm	Price/Piece (₹)
1199/1	2 Ltr.	150x150, without Hot Plate	11500.00
1199/2	2 Ltr.	150x150, with Hot Plate & Energy regulator	13000.00
1199/3	5 Ltr.	200x200, without Hot Plate	16220.00
1199/4	5 Ltr.	200x200, with Hot Plate & Energy Regulator	15850.00
1199/8	2 Ltr.	With hotplate 2 litre digital temperature controller & RPM Indicator	35960.00
1199/9	5 Ltr.	With hotplate 5 litre digital temperature controller & RPM Indicator	38140.00

1200. Water Baths Serological, "JSGW", Double Walled, outer Mild Steel Sheet, Epoxy Coated, Inner Chamber of Stainless Steel fitted with immersion heater, indicators, temperature upto 65°C, ± 1.0°C, is thermostatically controlled, supplied with Pyramidal lid and cord, but without racks.

Cat. No.	Inner Chamber mm	Capacity Ltr.	Price/Piece (₹)
1200/1	300 x 175 x 175	12	13665.00
1200/2	300 x 250 x 175	14	15525.00
1200/3	375 x 300 x 175	18	22600.00
1200/4	450 x 300 x 175	25	28270.00
1200/5	600 x 300 x 175	32	32285.00

- 1200D Water Baths Serological, "JSGW", Double walled, outer Mild Steel Sheet, Epoxy Coated, Inner Chamber of Stainless Steel with immersion heater, indicators, temperature upto 65°C, ± 1.0°C, is controlled by Digital temperature controller cum indicator supplied with Pyramidal lid and cord, but without racks.

Cat. No.	Inner Chamber mm	Capacity Ltr.	Price/Piece (₹)
1200D/1	300 x 175 x 175	12	31535.00
1200D/2	300 x 250 x 175	14	32930.00
1200D/3	375 x 300 x 175	18	42740.00
1200D/4	450 x 300 x 175	25	44515.00
1200D/5	600 x 300 x 175	32	48000.00

1201. Water Baths, "JSGW", Double Walled, Outer Mild Steel Sheet, Epoxy coated, Inner Chamber of Stainless Steel, Temp. is thermostatically Controlled 95°C ± 1°C, fitted with on/off switch, supplied with concentric rings and a cord.

Cat. No.	Inner Chamber mm	No. of Holes	Capacity Ltr.	Price/Piece (₹)
1201/1	300 x 250 x 100	6	8	16455.00
1201/2	400 x 300 x 100	12	15	22630.00

- 1201D Water Baths, "JSGW", Double Walled, Outer Mild Steel Sheet, Epoxy coated, Inner Chamber of Stainless Steel, Temp. is Controlled by Digital temp. controller cum indicator 95°C ± 1°C. fitted with on/off switch, supplied with concentric rings and a cord.

Cat. No.	Inner Chamber mm	No. of Holes	Capacity Ltr.	Price/Piece (₹)
1201D/1	300 x 250 x 100	6	8	37460.00
1201D/2	400 x 300 x 100	12	15	43870.00

- 1201A Precision Water Baths, "JSGW", Double Walled, outer Mild Steel Sheet, Epoxy Coated, Inner Chamber of Stainless Steel, fitted with immersion heater, Stirrer with speed regulator, Glass Window, Indicators and PID temperature controller. Temperature range 5°C above ambient to 100°C ± 0.1°C. Supplied with cord.

Cat. No.	Inner Chamber mm.	Price/Piece (₹)
1201A/1PID	425 x 250 x 225	73575.00
1201A/3PID	450 x 375 x 375	82325.00
1201A/5PID	600 x 450 x 450	98095.00

- 1201B. Water Bath Incubator Shaker, "JSGW", Double Walled, Outer Mild Steel Sheet, Epoxy coated, Inner Chamber Stainless Steel, S.S. pyramidal lid. The bath has an oscillating tray on rollers, oscillated through geared variable speed motor, Oscillation, Speed range is between 40 to 140 cycles per minutes. The shaking tray can either hold test tubes or conical flasks of 25 to 1000 ml. cap. (Cap to be specified by the user, while ordering). Temperature is controlled by the PID temperature controller, range ± 5° above ambient to 100°C ± 0.5°C. Provided with a cord and plug to work on 220 / 230 V AC supply.

Cat. No.	Shaking Tray (W x D x H)	Capacity Ltr.	Price/Piece (₹)
1201B/1PID	275 x 275 x 150 mm	12	109825.00
1201B/3PID	405 x 300 x 150 mm	18	127165.00

- 1203 Water Bath Universal, "JSGW", Temp. Controlled, Double Walled, stainless steel chamber, one Pyramidal lid and the other rectangular with holes covered with concentric rings, provided with water over flow arrangement, immersion heater, pilot lamp and on/off switch.

Cat. No.	Inner Chamber mm	Capacity Ltr.	Price/Piece (₹)
1203/1	300 x 225 x 175	14	21160.00
1203/2	450 x 300 x 175	25	29040.00



1200 D



1201



1201A



1201B



1203



1203D

1203D **Water Bath Universal, "JSGW"**, Double walled, outer M.S. sheet, epoxy coated, inner chamber of stainless steel, one Pyramidal lid and the other rectangular, with holes covered with concentric rings, provided with water over flow arrangement, immersion heater, Temperature is controlled by **Digital temperature controller** cum indicator  $95^{\circ}\text{C} \pm 1^{\circ}\text{C}$ , pilot lamp and on/off switch.

Cat. No.	Inner Chamber mm	Capacity Ltr.	Price/Piece (₹)
1203D/1	300 x 225 x 175	14	38205.00
1203D/2	450 x 300 x 175	25	44665.00



1204

1204 **Water Bath Rectangular, "JSGW"**, Single Walled Stainless Steel Chamber, Stainless steel top with holes and concentric rings, water over flow arrangement, rests on an angle iron frame. It is fitted with an immersion heater which is self ejecting on getting dry.

Cat. No.	Inner Chamber mm	No. of Holes	Price/Piece (₹)
1204/1	300 x 250 x 100	6	9175.00
1204/2	350 x 400 x 100	12	12825.00



1205D

1205D. **Cylindrical Oil Bath, Double Walled**, inner chamber of stainless steel, duly epoxy powder coated. The gap between two walls is filled with high grade glass wool to minimize thermal loss. Temp. range  $50^{\circ}$  to  $300^{\circ}\text{C}$ , temp. controlled by **Digital temp. controller** cum indicator. Supplied complete with plug and cord to work on 220/230 volts AC supply

Cat. No.	Flask Cap.	Watts	Price/Piece (₹)
1205D/1	1 Litre	500	38310.00
1205D/2	2 Litre	1000	39075.00
1205D/3	3 Litre	1500	46655.00
1205D/4	5 Litre	1500	47270.00
1205D/5	10 Litre	2000	52985.00



1206

1206. **Melting Point Apparatus, "JSGW"** A metallic heating block heated with superior quality element. A focusable lens, shadowless lamp, regulator to control the heat. Unit is housed in a cast metal, pannel fitted with neon light, on/off switch & regulator, knob & a thermometer holding rod. (₹) 7510.00



1206A

1206/A **Digital melting point Apparatus**, Designed for accurate determination of melting points of solid samples. Apparatus comprises of Cylindrical Silicon oil bath, built in magnetic stirrer with speed controller, electronic heat controller, Digital Temp. display with PT 100 sensor, Glare free background light with adjustable light intensity, provision for holding the melting point display.

Cat. No.	Description	Price/Piece (₹)
1206A/1	Temp. range $2^{\circ}$ above RT- $250^{\circ}\text{C} \pm 1.0^{\circ}\text{C}$ , $3\frac{1}{2}$ digit LED	49660.00
1206A/2	Temp. range $2^{\circ}$ above RT- $250^{\circ}\text{C} \pm 0.1^{\circ}\text{C}$ , $4\frac{1}{2}$ digit LED	59460.00

- 1207 **Automatic Pipette Washer, "JSGW"** 63 cm. high, 15 cm dia. approx. Stainless Steel. Cylindrical Jar with symphon system, water inlet and outlet and a pipettes holding device. 16105.00
- 1209 **Water Stills, Manesty Type, "JSGW"**, Complete S.S. body, electrically operated, easily replaceable immersion type heaters and wall mounting arrangement. Output 3-4 ltr./hr. 19430.00
- 1209A **Spare Heater of Water Stills, ISI Marked.** 1660.00

1210D **Oven Universal "JSGW"**, outer body made of thick Mild Steel Sheet duly Powder coated. Double walled construction with 2½" gap filled with best quality glass wool. Inner chamber made of Stainless Steel. Heating element are provide at bottom and two sides. Temp. Range from +5° Ambient to 250°C ± 1°C fitted with Microprocessor based PID electronic digital Temp. controller cum Indicator. Fitted with Air circulating fan, temp controller knob, perforated shelves and workable on 220 Volts 50 Hz AC mains. Rubber feet are fitted at bottom from corners for (Smaller Sizes).

Cat. No.	Inner Chamber	Capacity Liters	Chamber Size (mm)	Price/Piece (₹)
1210D/2	S.S	28	300 x 300 x 300	55050.00
1210D/4	S.S	45	350 x 350 x 350	56885.00
1210D/6	S.S	95	450 x 450 x 450	69200.00
1210D/8	S.S	125	600 x 450 x 450	89360.00
1210D/10	S.S	224	600 x 600 x 600	100715.00
1210D/11	S.S.	252	900 x 600 x 450	132070.00
1210D/12	S.S.	336	900 x 600 x 600	153235.00
1210D/13	S.S.	720	900 x 900 x 900	228300.00

*Note : Air circulating fan can be fitted in each size if required at an extra cost of ₹ 4800.00 and for ovens of 300°C, 25% will be charged extra.*

1224D. **Incubator Universal (Mettmert Type) "JSGW"** outer body made of thick Mild Steel Sheet duly Powder coated. Double walled construction with "2½ gap filled with best quality glass wool. Inner chamber made of Stainless Steel. Heating element are provide at bottom and two sides. Temp. Range from +5° Ambient to 80°C ± 1°C fitted with Microprocessor based PID electronic digital Temp. controller cum Indicator. Fitted with Air circulating fan, temp controller knob, perforated shelves and workable on 220 Volts 50 Hz AC mains. Rubber feet are fitted at bottom from corners for (Smaller Sizes).

Cat. No.	Inner Chamber	Capacity Liters	Chamber Size (mm)	Price/Piece (₹)
1224D/2	S.S	28	300 x 300 x 300	55685.00
1224D/4	S.S	45	350 x 350 x 350	57460.00
1224D/6	S.S	95	450 x 450 x 450	69665.00
1224D/8	S.S	125	600 x 450 x 450	89900.00
1224D/10	S.S	224	600 x 600 x 600	101175.00
1224D/11	S.S	252	900 x 600 x 450	134530.00
1224D/12	S.S	336	900 x 600 x 600	162550.00



1207

1209



1210D



1224D



1225

1225. **B.O.D. Incubator (Biochemical Oxygen Demand) "JSGW"** Low temperature Incubator. Outer body made of Mild steel duly powder coated and inner chamber made of Stainless Steel Grade 304. Fitted with 2 Air circulation fans. Inner viewing lamp is provided. Double door with inner door made of acrylic for full view of the chamber and outer metal door with magnetic gasket. Hermetically sealed compressor (CFC Free) & CFC free refrigerant gas with a fan cooled condensing coil. Indicators for Main, heating and cooling process. Temperature range 5°C to 60°C ± 1°C, Controlled by digital temperature controller (PID).

Cat. No.	Inner Chamber	Capacity Liters	Inside Chamber Size mm	Vol.	Price/Piece (₹)
1225/1	S.S	112	455 x 410 x 610	4 Cu. Ft.	169915.00
1225/2	S.S	171	505 x 415 x 830	6.1 Cu.Ft.	189185.00
1225/3	S.S	280	570 x 550 x 875	10 Cu. Ft.	210200.00
1225/4	S.S	340	650 x 580 x 900	12 Cu. Ft.	241730.00
1225/5	S.S	420	700 x 650 x 900	15 Cu. Ft.	273260.00



1226

- 1226 **Laboratory Autoclave Vertical, "JSGW"** Electrically operated, double walled, inner & outer body made of **Stainless Steel. S .S.** Lid, having radial locking system. Working pressure 5 p.s.i. to 15 p.s.i. safety valve; Complete with water level indicator, water inlet & outlet system with vacuum breaker control box fitted with automatic pressure control switch, pressure gauge, with PI temperature indicator cum controller, low auto water cut-off system, steam release valve; pilot lamp, on / off switch for operation on 220 volts A/C main. Complete with Stainless Steel Basket.

Cat. No.	Cap. ltr.	Boiler (DepthxDia) mm	Price/Piece (₹)
1226/1	22	450 x 250	130525.00
1226/2	40	500 x 300	146435.00
1226/3	50	550 x 350	159180.00
1226/4	98	600 x 450	187520.00
1226/5	152	750 x 550	262515.00



1228

1228. **Vortex Shaker, "JSGW"**, Vibration type, variable speed, neoprene cup impart vigorous agitation to tubes, with touch on/off switch. 10425.00



1229

1229. **V.D.R.L. Shaker, "JSGW"**, It is useful for V.D.R.L Typing grouping as well as another agglutination test, also for mixing of solution in small flask, beaker, bottle. A timer is corporate in electrical circuit is being cut off automatically as soon as the setting is over, Platform 300x300 mm, variable speed, supplied with cord & plug to work on 220/300 volts AC 16220.00

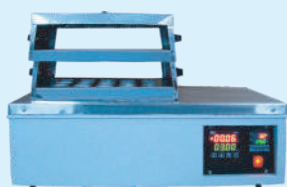

1230

1230. **C.O.D. Digestion Apparatus**, Aluminium Dry heating Block with 15 nos. cavities to accomodate 40 mm. dia tubes, heaters are placed below the block, ensures uniform heating, in a sheet metal housing, epoxy coated, temperature upto 200°C is controlled by digital temperature controller cum indicator, unit is fitted with timer, supplied with fifteen sets of glass reaction vessels and air condensers with standard joint fitting. 96070.00

- 1230/1 **Spare : Glass Part for C.O.D. Digestion Apparatus 1 Set** 1020.00

- 1231D **Rotary Shaker, "JSGW"**, Base assembly made from heavy mild steel section, Compact counter which helps balanced drive mechanism ensures high stability, Universal platform to accommodate interchangeable clamps of assorted sizes for holding different capacity of Glass. Speed range up to 300 RPM, timer Option with **DC drive** Supplied with cord and Plug to work on 220V single phase A/C.

Cat. No.	Platform Size	Price/Piece (₹)
1231/D1	18" X 18 " (with Digital RPM and Timer)	72345.00
1231/D2	24" X 24 " (with Digital RPM and Timer)	96170.00



1231D

1236. **Ultrasonic Cleaner(Sonicator)** : Micro Controller based digital timer, with latest MOSEFT base technology. Automatic frequency tuning for maximum output. Low transducer losses permit maximum cleaning action. Rugged & easy to clean SS housing. Extensively protected electronic circuit for longer & safe operation. Ultrasonic frequency 40 KHz, input voltage range 170 AC-270AC. 50hz with inbuilt digital timer, auto degassing, SS tank fitted with drain valve, supplied with basket, with water heater and Digital Temperature Controller.

Cat.No	Tank Size L x W x H	Cap. Ltr. (Approx)	Water Heater	Price/Piece (₹)
1236/1	150x135x110	1.5	✗	38365.00
1236/2	225x140x100	2.5	✓	47645.00
1236/3	300x150x100	4	✓	74445.00
1236/4	300x150x150	6	✓	105100.00
1236/5	300x240x150	10	✓	121835.00
1236/6	300x150x150	5	✓	96340.00



1236

- 1240D. **Rectangular Muffle Furnance "JSGW"**, (Laboratory Model) Light Weight, Outer casing made of thick PCRC sheet, duly powder coated, heating elements made of kanthal. A-1 wire are wound on the ceramic muffle, ceramic fibre insulation is provided on all sides. Temperature controlled by **Digital temp. controller cum indicator**, fitted on the front with two pilot lamps, one pyrometer, thermocouple, silver thermal fuse, main lead with power plug to work on 220/230 volts or 400/440 volts A.C. Max. Temperature is 1000°C, working temperature 900°C.

Cat. No.	Muffle Size (W x H xD)	Price/Piece (₹)
1240D/1	100x100x225mm	57385.00
1240D/3	125x125x300mm	74145.00
1240D/5	150x150x300mm	76755.00
1240D/7	200x200x300mm	103030.00



1240D



1241 D

1241. **Vacuum Oven** : Double walled with Outer M.S. sheet duly epoxy coated and inner made up of heavy gauge S.S. sheet. Gap between the two is filled with high grade glasswool to avoid thermal loss. Temp. range 50° to 150°C ± 1°C, fitted with digital controller cum indicator. Unit is capable of withstanding high vacuum. Provided with vacuum gauge, see through transparent window of toughened glass and one shelf. Works on 220 / 230 volts AC (Supplied without Vacuum Pump.)

Cat. No.	Dia & Depth	Price/Piece (₹)
1241/3	300x300mm	101950.00

1241D. **Vacuum Oven** : Double walled with Outer and inner body made up of heavy gauge S.S. sheet. Gap between the two is filled with high grade glasswool to avoid thermal loss. Temp. range 50° to 150°C ± 1°C, fitted with PID controller. Unit is capable of withstanding high vacuum. Provided with vacuum gauge, see through transparent window of toughened glass and one shelf. Works on 220/230 volts A.C. Supplied without Vacuum Pump.

Cat. No.	Dia & Depth	Price/Piece (₹)
1241D/3	300x300mm	147135.00



1245-1

1245/1	<b>Centrifuge Machine</b> (Doctor Model) (superior quality), 3500 RPM	7885.00
1245/2	<b>Centrifuge Machine</b> (Dom Type) four tube	7885.00
1245/3	<b>Centrifuge Machine</b> (Dom ype) Six tube	8060.00
1245/4	<b>Centrifuge Machine</b> (Dom Type) Eight Tube	8410.00



1245/2, 3, 4

## LABORATORY CLAMPS AND STANDS

### 1249. Laboratory Jack Box Type

Cat. No.	Ht.	Plate Size	M.S (₹) / each	S.S (₹) / each
1249/1	8"	6"x6"	3440.00	7650.00
1249/2	14"	8"x8"	4135.00	10540.00
1249/3	17"	10"x10"	5730.00	14215.00
1249/4	21"	12"x12"	7795.00	18335.00

### 1251. Burette Clamps, "JSGW", Made of thick Mild Steel sheet. All die-pressed-symmetrical, non-breakable, one holds the burette rests and other presses it due to spring force. Boss head can accommodate upto 18 mm. dia rod.

Cat. No.	Description	Price/Piece (₹)
1251/1	Single-For one Burette	180.00
1251/2	Double-For two Burettes	335.00
1251/3	Double-For two Burettes, Al. Casted, Spring Loaded	1210.00

### 1252. Universal Clamps, "JSGW", Sheet metal, Die-Pressed, cork lined jaws, can hold upto 12 to 50 mm dia.

Cat. No.	Description	Price/Piece (₹)
1252/1	M.S. Epoxy Coated	220.00
1252/2	Brass Chrome Plated	380.00

### 1253. Universal Clamps, "JSGW" (Condenser Clamp), Made of casted alloy, Cork lined jaws, can hold 75 mm dia articles, with chrome plated 8 mm. dia 175 mm long mild steel rod for holding in the boss head.

Cat. No.	Description	Price/Piece (₹)
1253/1	Aluminium, Epoxy coated	340.00
1253/2	Brass, Chrome Plated.	795.00

### 1254. Finger Clamps (Condenser), "JSGW", Made of casted alloy, prongs cross over one another, with chrome plated 8 mm. dia, 175 mm long mild steel rod for holding in the boss head.

Cat. No.	Description	Price/Piece (₹)
1254/1	3 Finger clamps—hold up to 75 mm. dia., Aluminium epoxy coated.	375.00
1254/2	— do — Brass, Chrome Plated	830.00
1254/3	4 Finger Clamps—hold up to 75 mm. dia., Aluminium epoxy coated.	375.00
1254/4	— do — Brass, Chrome Plated	830.00

### 1255. Condenser Clamps, "JUMBO".

Cat. No.	Description	Price/Piece (₹)
1255/1	4 Fingers covered with Silicon Sleeves, Jaws do not cross over, can hold upto 125 mm. dia. with 300 x 10 mm., C.P. rod. Brass casted, Chrome Plated.	2255.00
1255/2	— do — Aluminium casted, epoxy coated	1080.00



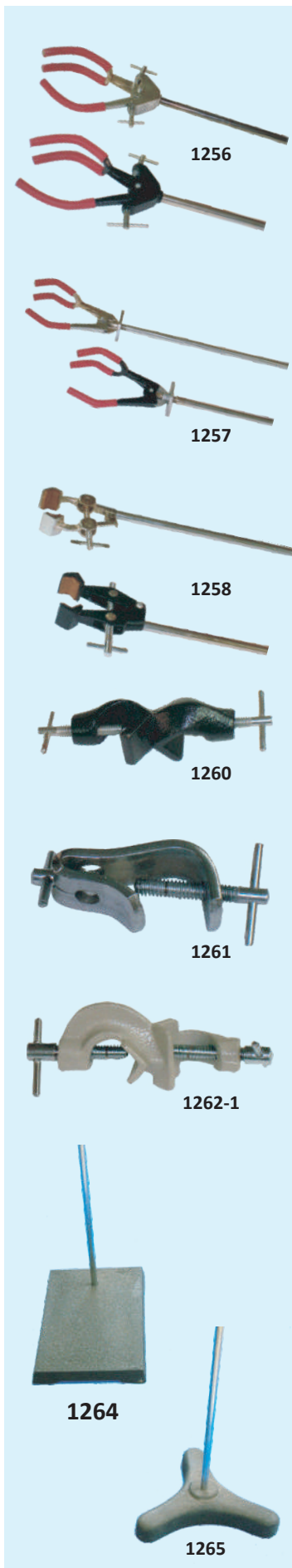

1256. **Condenser Clamp**, 3 Fingers covered with Silicon Sleeves, two keys independently operated, Chrome Plated Mild Steel Rod 300 x 10 mm.

Cat. No.	Description	Price/Piece (₹)
1256/1	Aluminium alloy, epoxy coated	795.00
1256/2	Brass casted, Chrome Plated	1645.00

1257. **Condenser Clamp**, "JSGW", Co-axial, 3 fingers covered with Silicon sleeves, can hold from 18 mm to 75 mm dia, with 300 x 10 mm. C.P. rod.

Cat. No.	Description	Price/Piece (₹)
1257/1	Brass sheet, Chrome Plated	1495.00
1257/2	M.S. sheet, epoxy coated	805.00

1258. **Retort Clamps**, "JSGW", Cork lined cylindrical jaws, can hold up to 50 mm., with 175 x 8 mm Chrome plate M.S. Rod.

Cat. No.	Description	Price/Piece (₹)
1258/1	Aluminium casted, epoxy coated	370.00
1258/2	Brass casted, Chrome Plated	795.00

1260. **Boss Head**, Cast iron, Black painted, with C.P. Screws.

		Price/Piece (₹)
1260/1	To hold upto 12 mm. dia rod	195.00
1260/2	To hold upto 16 mm. dia. Rod.	315.00
1260/3	To hold upto 25 mm. dia. Rod.	385.00

1261. **Boss Head**, Die-pressed, Chrome Plated, or epoxy coated made of thick mild steel strip, screws with plastic moulded hand grip, can accomodate up to 16 mm. dia rod.

127.00

1262. **Boss Head**, with chrome plated screws, to hold upto 16 mm. dia rod.

Cat. No.	Description	Price/Piece (₹)
1262/1	Aluminium casted , epoxy coated	150.00
1262/2	Brass casted, Chrome plated	735.00

1264. **Stand** : Rectangular Cast Iron Painted Base with mild steel Chrome Plated or powdered coated rod.

Cat. No.	Base	Rod	Price/Piece (₹)
1264/1	6" x 4"	18" x 3/8"	680.00
1264/3	8" x 5"	24" x 3/8"	875.00
1264/4	8" x 5"	24" x 1/2"	1025.00
1264/5	9" x 6"	30" x 1/2"	1510.00
1264/6	10" x 6"	24" x 1/2"	1955.00
1264/7	10" x 8"	30" x 1/2"	2425.00
1264/8	12" x 7"	36" x 1/2"	2635.00

1265. **Stand** : Tripod cast iron, hammerton painted base, with mild steel chrome plated rod.

Cat. No.	Base dia.	Rod	Price/Piece (₹)
1265/2	9"	24" x 1/2"	2685.00
1265/3	15"	36" x 3/4"	4025.00

1266. **Stand** : A shape cast iron hammerton painted base 6.5" side, with 24" x 1/2" mild steel chrome plated rod. 2100.00

1267 **Tripod Stand** : Cast iron black painted top, three balanced chrome plated screwed legs.

Cat. No.	Top	Height	Price/Piece (₹)
1267/1	Triangular 10cm	15cm	195.00
1267/2	Triangular 10cm	20cm	215.00
1267/3	Triangular 12cm	20cm	265.00
1267/4	Round, dia 12 cm	15cm	265.00
1267/6	Round, dia 12cm	20cm	320.00

1268. **Retort Ring**, made of iron, with fixed boss head to take upto 12 mm. dia. rod.

Cat. No.	Dia.	Price/Piece (₹)
1268/1	2"	195.00
1268/2	3"	205.00
1268/3	4"	225.00
1268/4	5"	265.00
1268/5	6"	300.00

1269. **Crucible Tongs**

Cat. No.	Length	Material	Price/Piece (₹)
1269/3	6"	Stainless Steel	155.00
1269/6	8"	Stainless Steel	190.00
1269/8	12"	Stainless Steel	480.00
1269/9	18"	Stainless Steel	820.00
1269/10	24"	Stainless Steel	1535.00

1270. **Tongs for holding flask, 12" long, Stainless Steel** 505.00

1271. **Tongs for holding beaker, 12" long, Stainless Steel** 505.00

1272. **Burner Bunsen**, made of thick brass pipe 12 mm dia., chrome plated, screw type air regulator. Painted heavy base, 150 mm. height Approx. 480.00

1272/1 – do – with stopcock 575.00

1272/2 **Bunsen Burner, Needle Valve**, base made of cast iron, powder coated, Needle valve, regulator to adjust flame with 12 mm tube dia 755.00

1272/3 **Electric Bunsen Burner**, 17695.00

1273. **Mecker Burner**, made of chrome plated brass tube, painted cast iron base, height 180 mm. approx. top dia 25 mm. with mesh 1250.00

1273/1 – do – with stopcock 1405.00

1274. **Teclu Burner**, made of chrome plated brass tube with regulating cone, give a powerful flame and higher temperature, painted cast iron base, height 160 mm. Approx. with Stopcock. 1695.00

**Note** : Please mention the gas to be used, while placing order for Cat. No. 1272 to 1274

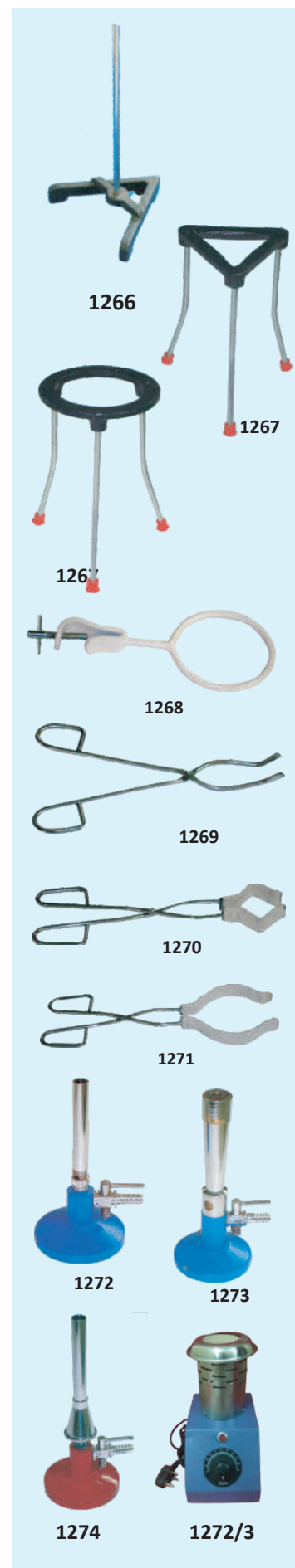



1276. Cork Borers, All brass, Chrome Plated.

Cat. No.	Set of	Minimum Qty/Pack	Price/Piece (₹)
1276/1	3, Heavy Pattern	2	1510.00
1276/3	6, Heavy Pattern	2	2230.00
1276/5	12, Heavy Pattern	2	4325.00

1277. Hoffman's Screw Clip, Brass Chrome Plated.

Cat. No.	Size mm.	Minimum Qty/Pack	Price/Piece (₹)
1277/1	12	5	205.00
1277/2	18	5	230.00
1277/3	25	5	280.00

1278. Test Tube Holder, chrome plated.

53.00

1279. Spatula, Stainless Steel, one end flat, one end spoon.

Cat. No.	Size Inches	Minimum Qty/Pack	Price/Piece (₹)
1279/1	4	10	48.00
1279/2	6	10	53.00
1279/3	8	10	72.00
1279/4	10	10	135.00
1279/5	12	10	180.00

1279A. Spatula, Stainless Steel, wire type.

Cat. No.	Size Inches	Minimum Qty/Pack	Price/Piece (₹)
1279A/1	6	10	75.00
1279A/2	8	10	91.00
1279A/3	10	10	115.00
1279A/4	12	10	155.00

1279F Forceps, SS, Fine Point, Straight, 316 Grade.

Cat. No.	Size mm.	Minimum Qty/Pack	Price/Piece (₹)
1279F/1	100	10	155.00
1279F/2	125	10	180.00
1279F/3	150	10	205.00
1279F/4	200	10	240.00
1279F/5	250	10	330.00
1279F/6	300	10	430.00

1280 Swan Neck Tap, Brass Chrome Plated.

Cat. No.	Type	Price/Piece (₹)
1280/1	One way	3415.00
1280/2	Two way	4700.00
1280/3	Three way	5975.00

1281. Gas tap, Brass moulded, Copper Oxidised / Chrome Plated.

Cat. No.	Type	Price/Piece (₹)
1281/1	One way	1150.00
1281/2	Two way	1380.00
1281/3	Three way	1645.00
1281/4	Four way	1930.00



1281

1282. Test tube Stands, made of Aluminium Anodised sheet .

Cat. No.	No. of Holes	Dia. of Hole mm.	Minimum Qty/Pack	Price/Piece (₹)
1282/1	12	12	2	430.00
1282/2	12	18	2	490.00
1282/3	12	25	2	655.00
1282/4	24	12	2	500.00
1282/5	24	18	2	670.00
1282/6	24	25	2	1020.00
1282/7	36	12	2	660.00
1282/8	36	18	2	880.00
1282/9	36	25	2	1285.00
1282/10	48	12	2	790.00
1282/11	48	18	2	1080.00
1282/12	48	25	2	1535.00
1282/13	72	12	2	1020.00
1282/14	72	18	2	1820.00
1282/15	72	25	2	2520.00
1282/16	12	38	2	1115.00

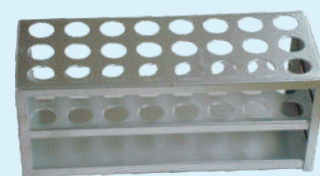

1282

1282 SS Test tube Stands, made of Stainless Steel.

Cat. No.	No. of Holes	Dia. of Hole mm.	Minimum Qty/Pack	Price/Piece (₹)
1282 SS/1	12	12	2	430.00
1282 SS/2	12	18	2	660.00
1282 SS/3	12	25	2	770.00
1282 SS/4	24	12	2	565.00
1282 SS/5	24	18	2	770.00
1282 SS/6	24	25	2	995.00
1282 SS/7	36	12	2	660.00
1282 SS/8	36	18	2	1020.00
1282 SS/9	12	38	2	1850.00



1282 SS

1282 W Wire Rack, made from complete stainless steel. Grade 304, Thickness 3 mm.

Cat. No.	No. of Holes	Dia. of Hole mm.	Minimum Qty/Pack	Price/Piece (₹)
1282 W/1	96	16	2	3415.00
1282 W/2	50	20	2	2990.00
1282 W/3	48	26	2	3415.00
1282 W/4	20	40	2	3415.00



1282 W

1283A. Nessler Cylinder Stand, for 50 ml. made of Aluminium Anodised , 12 holes. 1080.00

1283B. Nessler Cylinder Stand, for 100 ml. made of Aluminium Anodised , 12 holes. 1465.00



1284



1286



1290



1292

## 1284. Pipette can made from, Aluminium Anodised Sheet

Cat. No.	Dia.	Height	Price/Piece (₹)
1284/3	3"	18"	1555.00
1284/4	4"	18"	1745.00

## 1285. Pipette can, Stainless Steel

Cat. No.	Dia.	Height	Price/Piece (₹)
1285/3	3"	18"	1835.00
1285/4	4"	18"	2420.00

## 1286. Petri Dish Box, SS, to hold Ten 100 mm. dia dishes, with rack. 3565.00

## 1287. Storage Box for Vials made of 4 mm Perpex sheet, Air tight, with individual numbering.

Cat. No.	No. of Holes	Capacity ml.	Price/Piece (₹)
1287/1	50	5 ml vial	5925.00
1287/2	50	10 ml vial	7095.00

## WEIGHT BOXES

## 1290. Analytical Weight Boxes : All Brass, Chromium Plated weights with ivory tipped forceps, fitted in beautifully polished box with fractional weights set.

Cat. No.	Grade	Range	Price/Piece (₹)
1290/1	Class A	1mg to 50 gm	3455.00
1290/2	Class A	1mg to 100 gm	3925.00
1290/3	Class A	1mg to 200 gm	4570.00
1290/4	Class B	1mg to 50 gm	2710.00
1290/5	Class B	1mg to 100 gm	3145.00
1290/6	Class B	1mg to 200 gm	3565.00
1290/7	Class A	with NABL Certificate, S.S.100gm	18925.00
1290/8	Class A	with NABL Certificate, S.S. 200gm	23225.00

## 1292. Physical Weight Boxes, All weights chromium plated brass, supplied with forceps and fractional weight set fitted in polished box.

Cat. No.	Range	Price/Piece (₹)
1292/1	1 mg. to 100 gm	2705.00
1292/2	1 mg. to 200 gm	3360.00
1292/3	1 mg. to 500 gm	6815.00
1292/4	1 mg. to 1000 gm	12065.00
1292/5	1 mg. to 2000 gm	21545.00

## 1294. Analytical Fractional Weights, All weights rust proof nickel alloy, aluminium metal, in box. Capacity 1 mg to 500 mg.

Cat. No.	Grade	Price/Piece (₹)
1294/1	B	315.00
1294/2	A	1640.00

## ELECTROPHORESIS APPARATUS

1301.	<b>Paper Electrophoresis Apparatus, "JSGW"</b> (Dom type) migration chamber made of clear transparent insert material fitted with platinum electrodes, with coverlid of special pyramid type design so as to seal the central chamber to maintain high humidity and at the same time vent the electrodes chamber, with plug and socket without power pack.	27835.00												
1302.	<b>Immuno Electrophoresis Apparatus, "JSGW"</b> , Specially designed according to SHADON' comprising walled migration cell, made of white perspex outer chamber provided with inlets & outlets for circulation of cold water, inner chamber is the buffer chamber fitted with electrodes, with a clear transparent top lid fitted with a handle, a special perspex carrier is supplied as micro immunological accessory which permits simultaneous studies on upto eight 3" x 1" standard Agar coated micro slides, complete with plugs, terminals & leads. without powerpack, Size : 30 x 30 x 8 cms.	28410.00												
1303.	<b>Research Polyacrylamide Gel. (Disc) Electrophoresis App, "JSGW"</b> , Latest circular model designed according to 'SHADON', fabricated from clear transparent perspex, with separate detachable lower and upper chambers fitted with cylindrical Gel tubes of standard size, complete with electrodes, plug, leads, without power pack.	27795.00												
1304.	<b>Vertical Slab Gel Electrophoresis Apparatus, "JSGW"</b> , Complete with electrodes, sliding rods, for adjusting the height, Glass plates, Clamps to hold Glass plates, spacers, comb but without power pack.	27835.00												
1305.	<b>Digital Power Supply for above Electrophoresis</b> , Constant Current, Constant Voltage, with short circuit and overload protection, 0-300 Volts, 0 100mA.	17135.00												
1306.	<b>Paper Electrophoresis, Vertical</b> , with 3 paper hanging rods													
	<table border="1" style="width: 100%; border-collapse: collapse;"> <thead> <tr> <th style="text-align: left;">Cat.No.</th> <th style="text-align: center;">For No. of paper strips</th> <th style="text-align: center;">Buffer required</th> <th style="text-align: right;">Price/Piece (₹)</th> </tr> </thead> <tbody> <tr> <td>1306/1</td> <td style="text-align: center;">3</td> <td style="text-align: center;">200ml</td> <td style="text-align: right;">24735.00</td> </tr> <tr> <td>1306/2</td> <td style="text-align: center;">6</td> <td style="text-align: center;">300ml</td> <td style="text-align: right;">26680.00</td> </tr> </tbody> </table>	Cat.No.	For No. of paper strips	Buffer required	Price/Piece (₹)	1306/1	3	200ml	24735.00	1306/2	6	300ml	26680.00	
Cat.No.	For No. of paper strips	Buffer required	Price/Piece (₹)											
1306/1	3	200ml	24735.00											
1306/2	6	300ml	26680.00											
1307.	<b>Submarine Gel Electrophoresis, "JSGW"</b> with buffer chamber, safety lid with cables and following standard accessories. <ul style="list-style-type: none"> <li>• Comb 9 Wells - 10 Teeth (Set of 2Pcs.)</li> <li>• Comb 11 Wells - 12 Teeth (Set of 2Pcs.)</li> <li>• Comb 13 Wells - 14 Teeth (Set of 5Pcs.)</li> <li>• Casting Tray, Size 10x7cm (Set of 2Pcs.)</li> <li>• Casting Tray, Size 7x7cm (Set of 2Pcs.)</li> <li>• Electrode Set (Set of 2Pcs.)</li> </ul>	29260.00												
1310	<b>UV Trans illuminator for molecular Biology applications in college, Universities and research Institutes.</b> <ul style="list-style-type: none"> <li>• Wave Length 365 NM fixed</li> <li>• No. of UV tubes 8 Imported</li> <li>• Wattage 8 Watts</li> <li>• Detection Limit 200 Ng</li> <li>• Blue Print Area 185 x 185 Nm</li> <li>• UV Protection Shield Yes</li> <li>• Body Ms Powder Coated</li> </ul>	54870.00												



**1303**



**1304**



**1307**

## LABORATORY RUBBER TUBING

1320. Laboratory Rubber Tubing, Extra Soft quality. Temp.range -20°C to 70°C.



1320

Cat. No.	Approx.Bore mm.	Wall Thickness mm.	Price/10 mtr. (₹)
1320/1	4	1.0	430.00
1320/2	5	1.5	545.00
1320/3	6	1.5	695.00
1320/4	7	1.5	800.00
1320/5	8	1.5	920.00
1320/6	9	2.0	1110.00
1320/7	10	2.0	1350.00
1320/8	12	2.0	1530.00

1322. High Pressure Rubber Tubing, Superior quality.Temp.range -20°C to 70°C.



1322

Cat. No.	Approx.Bore mm.	Wall Thickness mm.	Price/10 Mtr. (₹)
1322/1	3.0	5	1235.00
1322/2	4.5	5	1460.00
1322/3	6.0	5	1700.00
1322/4	8.0	5	2095.00
1322/5	9.0	5	2310.00
1322/6	12.5	6	3745.00

1323. Ordinary Pressure Rubber Tubing, Superior quality.Temp.range -20°C to 70°C.

Cat. No.	Approx.Bore mm.	Wall Thickness mm.	Price/10 Mtr. (₹)
1323/1	3.0	3	790.00
1323/2	5.0	3	945.00
1323/3	6.0	3	1160.00
1323/4	8.0	3	1395.00
1323/5	9.0	3	1555.00
1323/6	12.5	4	3265.00

1324 V Tube Vacuum, made of pure Natural Rubber. Used for high pressure application. Available in per meter. Wall does not collapse at high pressure application. (Vacuum tube available in 1mtr. length only)

Cat. No.	I.D. mm.	O.D. mm.	Minimum Qty/Pack	Price/Piece (₹)
1324V/1	6	19	2	1570.00
1324V/2	8	22	2	1790.00

1324. Silicon Rubber Tubing. Temp.range -50°C to 250°C. Shore hardness 45A.



1324

Cat. No.	O.D. mm.	I.D. mm.	Wall Thickness mm.	Price/Mtr. (₹)
1324/1	4	2	1	90.00
1324/2	5	3	1	140.00
1324/3	6	4	1	190.00
1324/4	7	5	1	235.00
1324/5	7	4	1.5	235.00
1324/6	8	6	1	320.00
1324/7	8	5	1.5	320.00
1324/8	8	4	2	380.00

Contd. on next page

Cat. No.	O.D. mm.	I.D. mm.	Wall Thickness mm.	Price/Mtr. (₹)
1324/9	9	6	1.5	380.00
1324/10	10	7	1.5	440.00
1324/11	10	6	2	440.00
1324/12	11	8	1.5	510.00
1324/13	11	7	2	510.00
1324/14	12	8	2	525.00
1324/15	12	6	3	915.00
1324/16	14	10	2	995.00
1324/17	14	8	3	1090.00
1324/18	16	12	2	1100.00
1324/19	16	10	3	1260.00
1324/20	19	12	3.5	1730.00
1324/21	23	15	4	2415.00

1325. Silicon Rubber Cork

Cat. No.	Bottom Dia mm.	Top Dia. mm.	Height mm.	Price/Piece (₹)
1325/1	9	11.5	20	32.00
1325/2	11	14	24	52.00
1325/3	13	16	24	55.00
1325/4	15	18	24	73.00
1325/5	17	20	26	95.00
1325/6	18	21	26	105.00
1325/7	19	22.5	28	120.00
1325/8	23	25.5	28	180.00
1325/9	25	28.5	28	210.00
1325/10	27	31	32	250.00
1325/11	29	33	32	320.00
1325/12	31	36	35	395.00
1325/13	33	38.5	38.5	535.00

1326. Septa, Turnover flange with serration.

Cat. No.	Rubber Type	For Test Tube mm.	Price/10 Piece (₹)
1326/1	Natural	12	385.00
1326/2	Natural	15	450.00
1326/3	Natural	18	620.00
1326/4	Natural	25	760.00
1326/5	Silicon	12	750.00
1326/6	Silicon	15	940.00
1326/7	Silicon	18	1315.00
1326/8	Silicon	25	1600.00

1326A Septa, Turnover flange with serration.

Cat. No.	Rubber Type	For Socket mm.	Price/10 Piece (₹)
1326A/1	Natural	B14	615.00
1326A/2	Natural	B19	830.00
1326A/3	Natural	B24	980.00
1326A/4	Natural	B29	1225.00
1326A/5	Silicon	B14	1225.00
1326A/6	Silicon	B19	1915.00
1326A/7	Silicon	B24	2255.00
1326A/8	Silicon	B29	3475.00



1324



1325



1326  
Natural



1326  
Silicon



1327

1327. Septa, Turnover flange with Non-serration.

Cat. No.	Rubber Type	For Test Tube mm.	Price/10 Piece (₹)
1327/1	Natural	12	385.00
1327/2	Natural	15	450.00
1327/3	Natural	18	620.00
1327/4	Natural	25	760.00
1327/5	Silicon	12	750.00
1327/6	Silicon	15	940.00
1327/7	Silicon	18	1315.00
1327/8	Silicon	25	1600.00

1327A Septa, Turnover flange with Non-serration.

Cat. No.	Rubber Type	For Socket mm.	Price/10 Piece (₹)
1327A/1	Natural	B14	615.00
1327A/2	Natural	B19	830.00
1327A/3	Natural	B24	980.00
1327A/4	Natural	B29	1225.00
1327A/5	Silicon	B14	1175.00
1327A/6	Silicon	B19	1835.00
1327A/7	Silicon	B24	2160.00
1327A/8	Silicon	B29	3330.00



1328

1328. Rubber Cone for Filtration Flask. To avoid glass to glass contact.

Cat. No.	Suitable for Filter Flask ml.	Price/Piece (₹)
1328/1	250	145.00
1328/2	500	145.00
1328/3	1000	235.00
1328/4	2000	235.00
1328/5	5000	315.00
1328/6	10000	585.00

1329. Rubber Cork extra soft quality. Shore hardness is 45-50A.



1329

Cat. No.	Top Dia mm.	Bottom Dia. mm.	Height Mm.	No.	Price/10 Pcs (₹)
1329/1	13	9	15.5	0	45.00
1329/2	14	11	18.5	1	54.00
1329/3	16.5	13	20	2	67.00
1329/4	19	14	21	3	81.00
1329/5	21	15	22	4	90.00
1329/6	22.5	17.5	23	5	100.00
1329/7	24.5	20	24	6	138.00
1329/8	26	20	27.5	7	155.00
1329/9	26.5	21	27.5	8	180.00
1329/10	28	21.5	31	9	230.00
1329/11	30	26	32	10	280.00
1329/12	33.5	30	33.5	11	315.00
1329/13	34.5	30	34.5	12	355.00
1329/14	38.5	31	37	13	500.00
1329/15	41.5	32	42.5	14	550.00
1329/16	43.5	34	40.5	15	700.00
1329/17	45	35.5	36.5	16	740.00
1329/18	49.5	40	40.5	17	865.00

Note : For one hole Rs. 3.00 & Two hole 4.00 extra charge.

1330. **Police Man Silicon Rubber 5 mm Hole for Insert** 155.00

1335. **Pipette Bulb**

Cat. No.	Size	Price/Pc (₹)
1335/1	Small	35.00
1335/2	Medium	39.00
1335/3	Large	52.00
1335/4	Extra Large	54.00

1336. **Chloroform Bellow with cotton net** 585.00

1337. **Automizer Bulb** 200.00

1338. **Rubber Teat for dropper** 10.00

1339. **Propiptor (Pipette Filler)** 210.00

1340. **Silicon Propiptor (Auto Pipette Filler)** 690.00

1341. **Crucible Selve (Set of seven)** 560.00

1342. **Silicon Spreader, It has 5mm bore for rod.** 138.00

1343. **Silicon, Flask Stand, For Round Bottom Flasks.**

Cat. No.	Flask Size ml	Minimum Qty./Pack	Price/Piece (₹)
1343/1	50	2	280.00
1343/2	100	2	400.00
1343/3	250	2	590.00
1343/4	500	2	1105.00
1343/5	1000	2	2300.00
1343/6	2000	1	4915.00
1343/7	25	2	245.00

1344. **Silicon Pipette filler, Pipette bulb**

Cat. No.	Size mm	Suction Cap. (Approx.)	Minimum Qty./Pack	Price/Piece (₹)
1344/1	Small	5 ml	5	88.00
1344/2	Medium	10 ml	5	109.00
1344/3	Large	15 ml	5	138.00
1344/4	X-Large	20 ml	5	160.00
1344/5	Oval Shape	25 ml	5	260.00
1344/6	XX-Large	50 ml	5	500.00
1344/7	XXX-Large	100 ml	5	680.00

1345. **Rubber Sheets, used to avoid direct surface contact of Glassware product on the solid surface.**

Cat. No.	Size	Rubber Type	Minimum Qty./Pack	Price/Piece (₹)
1345/1	9.5"x9.5"x2.7mm	Silicon	2	2935.00
1345/2	9.5"x9.5"x2.7mm	Natural	4	295.00

1346. **Silicon Rubber Cork for "JSGW" Filter Flask.**

Cat. No.	Capacity Filter Flask	Minimum Qty./Pack	Price/Piece (₹)
1346/1	50ml	5	90.00
1346/2	100ml	5	100.00
1346/3	250ml	5	245.00
1346/4	500ml	5	475.00
1346/5	1000ml	5	475.00
1346/6	2000ml	5	720.00
1346/7	5000ml	5	1030.00



1330



1335/1



1338



1340

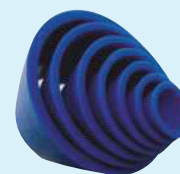

1341



1343

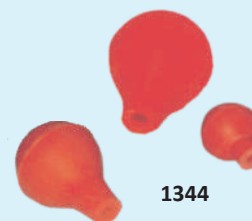

1344



1345



1346

## LIQUID HANDLING EQUIPMENT MICRO PIPETTES

1401. **Single Channel Variable Volume Micropipette**, Fully Autoclaveable, calibration as per ISO 8655 standards.

**Features:**

- Fully Autoclaveable
- CE Marked
- Ergonomic design ensuring light weight & soft plunger movement.
- High accuracy & precision guaranteed.
- Calibration report with each pipette.
- Built in stream lined tip ejector facilities easy tip ejection & access to narrow necked both tubes & bottles.
- Constructed of high quality plastic, combined with SS piston for many years of dependable service.

Cat. No.	Volume (Range)	Inc. $\mu\text{l}$	Vol. $\mu\text{l}$	Acc. $\mu\text{l}$	CV $\mu\text{l}$	Price/Piece (₹)
1401/1	0.2-2.0 $\mu\text{l}$	0.01	0.2	12.0	6.0	5305.00
			1.0	2.5	1.5	
			2.0	1.5	0.7	
1401/2	0.5-10 $\mu\text{l}$	0.1	0.5	5.0	2.8	5305.00
			5.0	1.5	0.8	
			10.0	1.0	0.4	
1401/3	2-20 $\mu\text{l}$	0.1	2.0	5.0	1.5	5305.00
			10.0	1.0	0.6	
			20.0	1.0	0.3	
1401/4	5-50 $\mu\text{l}$	1.0	5.0	2.5	6.0	5305.00
			25.0	0.7	1.5	
			50.0	0.7	0.7	
1401/5	10-100 $\mu\text{l}$	1.0	10.0	2.5	2.8	5305.00
			50.0	0.8	0.8	
			100.0	0.8	0.4	
1401/6	20-200 $\mu\text{l}$	1.0	20.0	2.5	1.5	5305.00
			100.0	1.0	0.6	
			200.0	0.6	0.3	
1401/7	100-1000 $\mu\text{l}$	10.0	100.0	1.6	0.3	5305.00
			500.0	0.6	0.2	
			1000.0	0.5	0.2	
1401/8	500-5000 $\mu\text{l}$	100.0	500.0	1.5	0.3	5305.00
			2500.0	0.6	0.2	
			5000.0	0.6	0.2	
1401/9	1000-10000 $\mu\text{l}$	100.0	1000.0	1.5	0.3	5305.00
			5000.0	0.6	0.2	
			10000.0	0.6	0.2	



1401



1401 N

1401N **Single Channel Variable Volume Micropipette**, Fully Autoclaveable, calibration as per ISO 8655 standards, with NABL Certificate.

**Features:** As per Cat. 1401

Cat. No.	Volume (Range)	Inc. $\mu\text{l}$	Vol. $\mu\text{l}$	Acc. $\mu\text{l}$	CV $\mu\text{l}$	Price/Piece (₹)
1401N/7	100-1000 $\mu\text{l}$	10.0	100.0	1.6	0.3	7100.00
			500.0	0.6	0.2	
			1000.0	0.5	0.2	
1401N/8	500-5000 $\mu\text{l}$	100.0	500.0	1.5	0.3	7100.00
			2500.0	0.6	0.2	
			5000.0	0.6	0.2	
1401N/9	1000-10000 $\mu\text{l}$	100.0	1000.0	1.5	0.3	7100.00
			5000.0	0.6	0.2	
			10000.0	0.6	0.2	

1402. **Quickpip Fixed Volume Micropipette**, with fully Autoclavable, Calibration, Accuracy as per ISO 8655, Digital Display. Stream lined tip ejector. Two step operation.

Cat. No.	Volume μl	Acc. ±%	CV	Price/Piece (₹)
1402/1	1.0	2.5	1.8	2685.00
1402/2	2.0	2.5	1.2	2685.00
1402/3	5.0	1.5	0.8	2685.00
1402/4	10.0	1.0	0.5	2685.00
1402/5	20.0	0.5	0.3	2685.00
1402/6	25.0	0.5	0.3	2685.00
1402/7	50.0	0.3	0.3	2685.00
1402/8	100.0	0.3	0.2	2685.00
1402/9	200.0	0.3	0.2	2685.00
1402/10	250.0	0.3	0.2	2685.00
1402/11	500.0	0.3	0.2	2685.00
1402/12	1000.0	0.3	0.2	2685.00
1402/13	2000.0	0.3	0.2	3150.00
1402/14	5000.0	0.3	0.2	3150.00
1402/15	10000.0	0.3	0.2	3150.00



1402

1403. **Quickpip Multichannel (8) Micropipette**, with Digital Display, streamlined tip ejector, two step operation, easy adjustment of volume by turning the plunger.

Cat. No.	Capacity Range	Price/Piece (₹)
1403/1	5 to 50 μl	27115.00
1403/2	40 to 200 μl	27115.00



1403

1404. **Tips for Micropipette.**

Cat. No.	Capacity	Pack Size	Price (₹)
1404/1	Yellow upto 200 μl	1000 pcs/pk	930.00
1404/2	Blue upto 1000 μl	500 pcs/pk	930.00



1404

1405. **Stand only for 6 Micropipettes.** 2015.00



1405



1411

1411. **Bottle Top Dispensers** : All wetted parts which comes in contact with reagents are made of PTFE, FEP and Borosilicate Glass, so can ben used for all Laboratory Reagents dispensing needs except HF High accuracy and precision is ensured through several stages of strict quality checks during manufacturing. Each Dispenser is calibrated in accordance with ISO 8655 Standard and supplied with certificate.

Product Information :

**Description**

- Piston
- Cylinder
- Valve Housing
- Valve Assembly
- Volume adjustment
- Delivery Tube
- Inlet Tube
- Discharge Assembly
- Compatibility

**Premium Model**

**Models**

- PTFE
- Glass
- PTFE**
- Glass Ball & Seat
- Screw Type
- FEP
- FEP
- PTFE
- Excellent with all reagents except HF.

Each dispenser is supplied with 1 standard adapter of 30 mm thread and 5 adapters of 28, 32, 36, 40 & 45 mm. to fit in most of the reagent bottles in Laboratories.

*Note : Instrument is fully autoclavable at 121°C, 15psi.*

Model	Vol. Range ml.	Increment ml.	Accuracy		CV		Price (₹)
			± %	± ml.	±%	± ml.	
JBTD-1	0.25 - 2.5	0.05	0.6	0.015	0.2	0.005	22280.00
JBTD-2	0.5 - 5	0.1	0.6	0.030	0.2	0.010	22280.00
JBTD-3	1 - 10	0.2	0.6	0.060	0.2	0.020	22280.00
JBTD-4	2.5 - 30	0.5	0.6	0.180	0.2	0.060	24045.00
JBTD-5	5 - 60	0.5	0.6	0.360	0.2	0.120	24045.00
JBTD-6	10 - 100	2.0	0.5	0.500	0.1	0.100	39560.00

# Index

## A

Absorption Bulb	118
Absorption Pipette	121
Absorption Vessel	131
Adapters	62-64, 146
Air Condenser	41
Air Leak Tube	68
Albuminometer	113
Alkoxy & Alkylimino Group Determination App.	84
Ammonia Distillation	81
Ampule Freeze Drying	117
Anaerobic Culture Jar	144
Anderson Pipette	123
Artificial Insemination Pipette	17
Arsenic Apparatus	131
Aspirator Bottles	112
Assemblies Distillation	81-84
Autoclaves	157
Automizer Bulb	169

## B

Basin Silica	143
Beakers	106,145
Beckman's Depression of Freezing Point App.	122
Beckman's App. for determination of Molecular Weight	122
Blood Sugar Tube	113
Blood Test Capillaries	114
Bottle Various	107-113,146
Bottle Gas Washing	120
Boiling Tube, Flasks	138
Boss Head	160
Buchhi Flash Evaporator	148
Boiling Point Apparatus	122
Buchner Flasks	53
Buchner Funnels	78
Burettes Various	1-9
Burners	161
Bunte Gas Burette	118
Butyrometers	132
B.O.D. Bottles	113
Brushes	28

## C

Calcium Chloride Tube	118
Calcium Chloride Tower	118
Calomel Electrodes	122
Capillaries Micro Blood	114
Carbaryl Content Determination Apparatus	84
Carbon Burette	131

Carbon Sulphur Glassware Glass Parts	131
Cassia Flask	29
Cavett Blood Test Apparatus	83
Centrifuge Tube	38,146
Centrifuge Machine	158
Charle's Law Apparatus	130
Chromatography Cabinet	147
Chromatography Columns & Assemblies	93-97
Chromatography Sprayer	128
Chromatography Vials	98-99
Chiller Refrigerated Circulator	148
Clamps	159-160
Clasien Head Stopping	65
Clinical Laboratory Glassware	113
Clevenger Apparatus	101
Co-Agulation Tube (Melting Point Tube)	114
Columns Fractionating	76
Cones	36
Crystallizing Dishes	123
Condensers	41-43
Conical Flasks	55-57
Connection Tube	128
Conway Diffusion Unit	117
Cottrel Crown	122
Cork Boring Machine	162
Cork Borers	162
Counting Chamber	115
Combustion Boat	142
Crude Fibre App.	150
Crow Receiver	35-36
Crucible Silica	143
Crimping Tools for Vials	99
Crucible Sintered	77
Crucible Tongs	161
Cylinders	31-36
Cylinder Rain Measure	35
Culture Flask	117
Culture Tubes	37
Crucible Sleeve	171
Cuvette	141
C.O.D. Digestion	157
Cyanide Distillation Apparatus (New)	84

## D

Dairy and Milk Testing App.	132
Dean and Stark Glassware	99-100
Decrimping Tools for Vials	99
Dessicators	128-129
Dessicator Cabinet	147

# Index

Deware Flask	127
Dialtometer	126
Dissoultion Bowl	123
Dirt Correction Glassware	123
Digestion Tube	129
Distillations, Assemblies	81-84
Distillation Apparatus	84-91
Distillaiton Flasks	54
Dishes Petri	115
Dishes Crystallising	123
Dishes Evaporating	123
Dispensers	172
Dreyer's Agglutination Tube	113
Dropping Bottles	111-112
Droppers	138
Dropping Funnels	74-75
Drying Tube	67
Durham Tube	114
Dispensers Bottles	172

## E

E.S.R. Tube	113
Electrode	122
Electrophoresis App.	165
Essential Oil Determination	101
Extractors	92
Extraction App. Electrical	150
Evaporating Dishes	123

## F

Filter Apparatus	77-80
Filter Pump	126
Filter Holder SS	79
Filter Flask	54
Filtering Funnel	127
Filter Tube	128,138
Flasks Evaporator	52
Flasks Volumetric Various	18-30,141
Flasks	44-58
Flasks Erlenmeyer	56
Flask Haffkine	58
Fluoride Distillation	84
Forceps	162
Fractionating Columns	76
Fractionating Assembly	83
Funnels Powder	127
Furnace Muffle	158
Freezing Point App.	123

## G

Gas Absorption Pipette Semi Micro	138
-----------------------------------	-----

Gas Tap	163
Gas Collecting Tube	119-120
Gas Desorber	117
Gas Washing Bottles	120
Gas Jar	120
Glass Beeds	76
Glass Jar	120
Glass Spreader	116
Ground Joints	59-60
Guides and Glands	69
Graduated Test Tubes	39-40

## H

Haemometer	116
Haemocytometer	115
Hample's Gas Burettes	118
Heating Mantle	151
Haffkine Flask	58
Hoffman's Voltmeter	122
Hoffman's Screw	162
Hot Plates	152
Homogenisers	116
Hydrometers	136-137
HPLC Vials	99

## I

Imhoff Cones	36
Impingers	117-118
Iodine Flask	55
Incubators	156
Interchangeable Ground Glass Assemblies	81-84

## J

Jacks	159
Jar - Bell	130
Jars Rectangular	130
Jar - Specimen	129

## K

Kahn's Antigen Dilution Tube	113
Kahn's Test Tube	113
Kemmerer, Hallet Apparatus	102
Kipp's Apparatus	120
Kjeldahl Digestion / Distillation Unit	149-150
Kjeldahl Digestion Tubes	129
Kjeldahl Bulbs	123
Kjeldahl Distillation	81
Kjeldahl Distillation Electrical	149-150
Kjeldahl Apparatus	102,149-150
Kjeldahl Flasks	53,56
Kozelka and Hine Blood Test Apparatus	83
Kohlraush Flasks	29
Kettles - Resin	131

# Index

## L

Lactometer	137
Land Berger's Apparatus	122
Lechatelier Flask	29
Leighton Tubes	37
Laboratory Jacks	159
Laboratory Stirrers	152
Laboratory Stand & Clamps	159-162
Laboratory Instruments	147-158
Laboratory Rubber Products	166-169
Liquid Handling Equipment	170-172

## M

Mac Cartney Bottle	113
Macro Kjeldahl Distillation	100
Magnetic Needle	145
Magnetic Stirrer	152
Magnetic Retrifer	146
Manometers	122
Markham Semi Micro Distillation	102
Measuring Cylinders	31-36
Measuring Flask, Weight Rings, Safety Riders	30
Membrane Filter Holder	78-79
McCoy's Apparatus	122
Mechanical Pipette	16
Melting Point Tube Thiel's	124
Melting Point Capillaries	113
Melting Point Apparatus	154
Mercury Distillation Assembly	83
Mercury Seal & Glands Guide	69
Milk Testing Apparatus	132
Molecular Weight App.	122
Micro Acetyl Group Determinaiton Apparatus (Wiesen Berger)	83
Micro Kjeldahl Distillation & Nitrogen Determination	102
Micro Pipettes	170-171
Mojjonier Flask	132
Molecular Weight Determination Apparatus	122
Moisture Determination Apparatus	99-100
Mancozels Content Apparatus	84
Microscope Slides	115
Mortar Pestle Semi Micro	139
Mud Flask	29
Muffle Furnace	158
Micro Capillaries	114
Museum Jars	130

## N

Nessler Cylinders	35
Nessler Cylinders Stand	163
Nitrometers Schiff's	119
Nitrogen Determination Assemblies	102
Neubauer Counting Chamber	115

## O

Oil Centrifuge	39
Oil Free Portable Vaccum Pump	80
Oil Bath	154
Orsat Gas Analysis App.	121
Ovens	155
Oxygen Determination Assembly	120
Oxygen Combustion Flask	123
Ostwald Viscometer	124

## P

Parnas and Wagner Assemblies	102
Packing for Columns	76
Packing Support	76
Particle Size Determination App.	123
Pasteur Pipette	17
Perkin Triangle	64
Petri Dish	116
Petri Dishes Box	164
Pipe Line Filter	79
Pipette Bulbs	169
Pipettes Can	164
Pipettes Various, Silicon Pipette Filler	10-17
Pipette Washer	155
Plant Pysiological App.	144
Platinum Wirefused	138
Polarimeter Tubes	127
Polenske's Apparatus	132
Police Man (Magnetic Retriever)	145
Power Supply	165
Pressure Equalising Funnels	74-75
Psychrometer	135
Pyknometer	108-109
PTFE Laboratory Ware	145-146
PTFE Stopcock	104
pH Electrode	122
Porcelain Ware	139-140

# Index

## Q

Quartz Distillation	88-91
Quartz (Transparent) Laboratory Ware	140-142
Quartz Cell	140
QR Coded Glasware	12, 19-25, 31

## R

R.B.C. Pipette	115
Rain Measure Cylinder	35
Reaction Assemblies	80
Reaction Flask	44
Reagent Bottles	109-111
Recovery Assemblies	80-83
Recovery Head Stopping	65
Rectangular Jar	130
Reflux Assemblies	80
Reichert Wollney's Apparatus	132
R.M. Value Apparatus	132
Retorts	126
Retort Ring	161
Rotary Flash Evaporator	148
Rotary Shaker	157
Rubber Tube	166
Rubber Cone for Filtration Flasks	168
Rubber Cork	168
Rubber Bellow	169
Rubber Bulbs / Teats	169
Roux Bottle	113
Retriver	146

## S

Sampling Tube	56
Saybolt Viscosity Flask	29
Sedimentation Pipette	123
Sedimentation Cylinder	35
Semi Micro Analysis Apparatus	138-139
Separating Funnels	70-72
Scraper PTFE	146
Screw Clip	162
Silica Laboratory Ware	143
Silicon Flask Holder	169
Silicon Rubber Tubing & Corks	166-167
Sintered Glassware	77-79
Slides Micro	115
Sockets	59-60
Solvent Recovery Assembly	83

Soxhlet Extraction App.	92,150
Soil Moisture Gauge	100
Spatula Ended Spoon	129, 162
Spatula S.S.	162
Specific Gravity Bottles	108
Specimen Jar	129
Spherical Joints	60
Splash Heads	65-66
Spot Plate	138
Sprayers	128
Standard Joints, PP Clamps, Stoppers	59-62
Stalganometer	126
Stand and Clamps	159-161
Steam Distillations Assemblies	81
Steam Distillation Heads	66
Stirrers	68-69
Stirrer Guides	69
Stirrer Rod	68
Still Heads	65
Stoppers	60-62
Stopcocks	103-104
Stuffing Box Glands	69
Suba Seals	167
Schoinger Micro Combustion Flask	123
Sugar Flasks	29
Sulphur Burette	131
Sulphonation Flasks	29
Syphon	126
Stainless Steel Clips	44
Swan Neck Tap	162

## T

Teflon Labware	145-146
Teflon Gaskets	44
Test Tube Stoppered	39
Test Tube	39-40
Test Tube Holder	138,162
Test Tube Brush	138
Test Tube Stand	163
Tilt Measure	16
Tips	171
Thin Layer Chromatography Kit	147
Thermometer Pocket	68
Thermometers	133-135
Thiel's Melting Point Tube	124
Thistle Funnel	127

# Index

Tissue Homogeniser's	116		
Tongs for Flasks & Beakers	161		
Tripod Stand	161		
Transport Number App.	122		
Trypsinising Flask	117		
Tubes	35-40		
Tutwiler Gas Burette	118		
Transillumator U.V.	165		
<b>U</b>			
U Tubes	67		
Ultra Violet Chromatrography Inspection Cabinet	147		
Ultrasonic Cleaner (Sonicator)	158		
Ureometers	113		
Utility Sets	84		
<b>V</b>			
VDRL Shaker	157		
VDRL Slides	115		
Vacuum Distillation Assembly	81		
Vacuum Drying Pistol	82		
Vacuum Oven	158		
Vacuum Pump	79		
Vacuum Stopcocks	104		
Vacuum Sublimation Assembly	81		
Vacustat Gauge	122		
Vapour Density Apparatus	122		
View Bulb	131		
Victor Mayer Apparatus	122		
Viscometer	124-125		
Vials	98-99		
Volumetric Flasks	18-29		
Voltameter Hoffman's	122		
Voltatile Oil Determination App.	99		
Vortex Shaker	157		
		<b>W</b>	
		W.B.C. Pipette	115
		Wasserman Tube	113
		Wash Bottles	120,123
		Watch Glass	139
		Water Baths	152-154
		Water Distillation	83-90
		Water Softner	91
		Water Stills	84-91
		Weighing Bottles	107
		Wire Racks	163
		Witts Filtering Apparatus	77
		Widal Tube	114
		Weighing Scoop	129
		Weight Boxes	164
		Weight Thermometer	126
		Wintrobe Tube	113
		Woulf Bottle	113



# LABORATORY GLASSWARE SAFETY TIPS

## Inspection

- Always inspect glass for scratches, abrasions, cracks or chips before using or cleaning.
- Safely dispose of any damage glass.
- Inspect glass routinely for strain with a polariscope.

## Heating Glass

- Heat with Mantles, Heat Tapes, Hot Plates, Immersion Heaters.
- Avoid direct flame as much as possible.
- Standard Temperature limit for Borosilicate Glass is 240°C.

## Temperature Borosilicate Glass

- Standard use limit - 240°C.
- Maximum short-term use - 490°C.
- Avoid rapid temperature changes or rapid thermal shock.

## Storage

- Store glass in a manner to avoid vessels bumping each other.

## Washing/ Cleaning Glass

- Always inspect glass for chips and fractures prior to cleaning, especially any solvent or acid cleaning.
- Avoid HF, Strong Alkalis or abrasive cleaners.
- Distilled water rinse.

Manufacturers :

**JAIN SCIENTIFIC GLASS WORKS**

14, HSIIDC, Industrial Estate, Jagadhari Road,  
Ambala Cantt. - 133 001 (INDIA)

Tele : 91-171-2698184, 2698185 ; Fax : 91-171-2698390  
E-Mail : [info@jsgw.com](mailto:info@jsgw.com) ; Web : [www.jsgw.com](http://www.jsgw.com)